

Direct sales vega-line.

Making measurement simple.

vega-line price list 2015|2016

Level and pressure instrumentation

vega-line – Standard solutions

Quickly and price-favourable

VEGA – world leader in measurement technology

VEGA is a world leader in continuous level measurement, switching and measurement of process and differential pressure. The technology from VEGA delivers reliable data on volume, level and pressure independent of the medium.

vega-line – fast, low cost measurement technology

vega-line is the direct distribution channel of VEGA. Products that are easy to project and that require hardly any consultation can be ordered quickly and easily by telefax, e-mail or via the web-shop. vega-line puts time-tested solutions for typical measuring tasks in the areas of level, switching and pressure at your fingertips.

Large quantities reduce the price

vega-line products are standard solutions that are much in demand. Large quantities enable cheaper production methods and reduce time and effort. We pass this benefit on to you.

Easy selection thanks to proven technology

vega-line makes you feel confident because the instruments offered here have proven themselves a thousand times over. These versions fulfil specifically the typical requirements of daily practice. Thus, you can quickly and easily select the most suitable instrument. You will find all the information you need in this price list.

Direct, easy and fast

You select the solution for your application and order the suitable product directly from VEGA. By phone, telefax, e-mail or online around the clock at our web-shop. It's quick and easy. And the instruments also get to you quickly, usually within some single days.

**Order quickly and simply in
the web shop:**

www.vega-line.uk

Content

	Liquids	Bulk solids	Gases	Page
Level				
Ultrasonic				
VEGASON S 61	☑	☑		4
VEGASON S 62	☑	☑		6
Hydrostatic				
VEGAWELL S 51	☑			8
Vibration				
VEGASWING S 51	☑			10
VEGASWING S 52	☑			12
VEGAVIB S 61		☑		14
VEGAWAVE S 61		☑		16
Pressure				
Process pressure				
VEGABAR S 14	☑		☑	18
VEGABAR S 16	☑		☑	20

VEGASON S 61

Ultrasonic sensor for continuous level measurement for measuring ranges up to 5 m

Application area

The VEGASON S 61 is an ultrasonic sensor for continuous level measurement of liquids and bulk solids. Typical applications are the measurement of liquids in storage vessels and open basins. The sensor is suitable for detection of bulk solids in small vessels or open containers.

The non-contact measuring principle enables a setup without medium.

Your benefit

- Non-contact measurement
- Reliable level measurement, independent of product properties
- Automatic sound running time correction through integrated temperature sensor

Function

Short ultrasonic pulses of approx. 70 kHz are emitted by the transducer in the direction of the measured product, reflected by the product surface and received back by the transducer. Ultrasonic pulses travel at the speed of sound. The time from emission to reception of the signals is proportional to the level in the vessel. The adjustment of the sensors is carried out via the indicating and adjustment module PLICSCOM.



Electrical connection

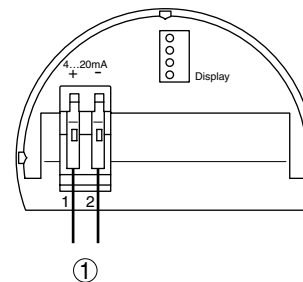

- 1 Voltage supply and signal output

Dimensions

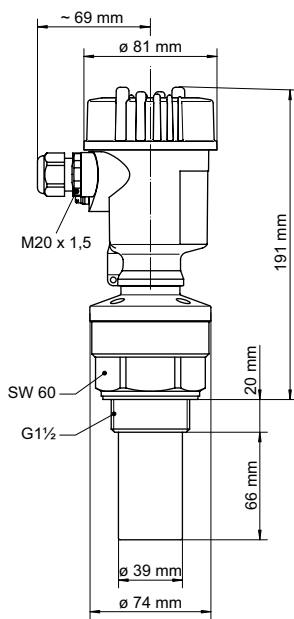

Technical data

Process pressure	-0.2 ... 2 bar
Process temperature	-40 ... +80 °C
Measuring range	in liquids: 0.25 ... 5 m in bulk solids: 0.25 ... 2 m
Dead band	250 mm
Accuracy	better than 0.2 % or ±10 mm
Output signal	4 ... 20 mA
Operating voltage	non-Ex instrument: 14 ... 36 V DC Ex instrument: 14 ... 30 V DC
Fault signal	20.5 mA, 22 mA, < 3.6 mA (adjustable)
Material, housing	plastic PBT
Protection	IP 66/IP 67
Material, wetted-parts	PVDF, EPDM
Approval	option: ATEX II 1G, 1/2G, 2G EEx ia IIC T6

You can find further information on our home page under www.vega-line.uk.

Net price per piece in GBP		515,00
Approval		
XX	without	-
EE	ATEX II 1G, 1/2G, 2G EEx ia IIC T6	140,00
Indicating/adjustment module (PLICSCOM)		
X	without	-
A	mounted	112,00
↓ ↓		
SONS61.E <input type="text"/> <input type="text"/>		

Accessory	Order number	Price in GBP
Mounting bracket 200 x 250 mm / 304	2.33437	98,00
Counter nut G1½ / PP	2.10371	10,00
PLICSCOM Pluggable indicating and adjustment module with menu-driven adjustment, user-friendly clear text display and large, easily readable digits	PLICSCOM.XB	112,00

VEGASON S 62

Ultrasonic sensor for continuous level measurement for measuring ranges up to 8 m

Application area

The VEGASON S 62 is an ultrasonic sensor for continuous level measurement of liquids and bulk solids. Typical applications are the measurement of liquids in storage vessels and open basins. The sensor is suitable for the detection of bulk solids in small vessels or silos. You can find application areas in all industries. The non-contact measuring principle enables a setup also without medium.

Your benefit

- Non-contact measurement
- Reliable level measurement independent of product properties
- Automatic sound running time correction through integrated temperature sensor

Function

Short ultrasonic pulses of approx. 50 kHz are emitted by the transducer in the direction of the measured product, reflected by the product surface and received back by the transducer. Ultrasonic pulses travel at the speed of sound. The time from emission to reception of the signals is proportional to the level in the vessel. The adjustment of the sensors is carried out via the indicating and adjustment module PLICSCOM.



Electrical connection

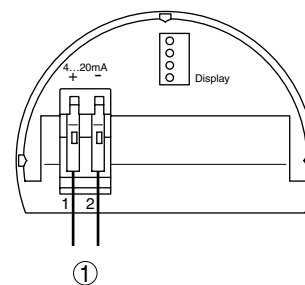

- 1 Voltage supply and signal output

Dimensions

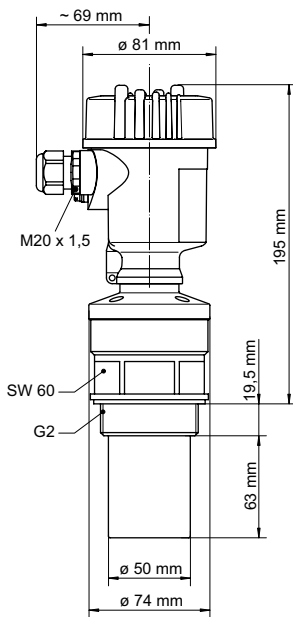

Technical data

Process pressure	-0.2 ... 2 bar
Process temperature	-40 ... +80 °C
Measuring range	in liquids: 0.4 ... 8 m in bulk solids: 0.4 ... 3.5 m
Dead band	400 mm
Accuracy	better than 0.2 % or ±10 mm
Output signal	4 ... 20 mA
Operating voltage	non-Ex instrument: 14 ... 36 V DC Ex instrument: 14 ... 30 V DC
Fault signal	20.5 mA, 22 mA, < 3.6 mA (adjustable)
Material, housing	plastic PBT (Polyester)
Protection	IP 66/IP 67
Material, wetted-parts	PVDF, EPDM
Approval	option: ATEX II 1G, 1/2G, 2G EEx ia IIC T6

You can find further information on our home page under www.vega-line.uk.

Net price per piece in GBP		563,00
Approval		
XX	without	-
EE	ATEX II 1G, 1/2G, 2G EEx ia IIC T6	144,00
Indicating/adjustment module (PLICSCOM)		
X	without	-
A	mounted	112,00
↓ ↓		
SONS62.E	<input type="checkbox"/>	<input type="checkbox"/>

Accessory	Order number	Price in GBP
Mounting bracket 200 x 250 mm / 304	2.33438	98,00
Counter nut G2 / PP	2.21638	12,00
PLICSCOM Pluggable indicating and adjustment module with menu-driven adjustment, user-friendly clear text display and large, easily readable digits	PLICSCOM.XB	112,00

VEGAWELL S 51

Submersible pressure transmitter for level measurement of liquids

Application area

The VEGAWELL S 51 is suitable for continuous level measurement of liquids, particularly for gauge measurement in water basins, waste water shafts, deep wells and applications on ships.

Due to its versatile and simple mounting options, the VEGAWELL S 51 is an economical solution.

Your benefit

- High reliability through maximum overload and vacuum resistance of the ceramic measuring cell
- High plant availability through integrated overvoltage protection
- Versatile use through robust housing and cable versions

Function

The dry, ceramic measuring cell CERTEC® is the heart of VEGAWELL S 51. The hydrostatic pressure of the liquid column causes a capacitance change in the measuring cell via the ceramic diaphragm. This change is converted into a standardised 4 ... 20 mA signal.



Electrical connection

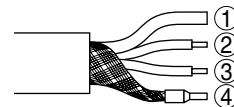

- 1 Breather capillaries with filter element
- 2 brown (+): Voltage supply and signal output
- 3 blue (-): Voltage supply and signal output
- 4 Screen

Dimensions

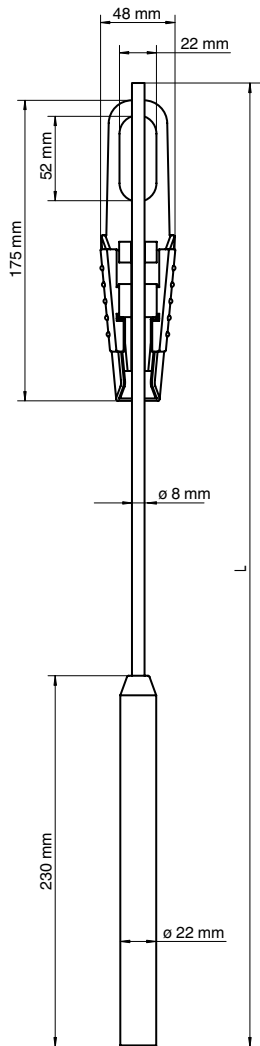

Version with straining clamp (see accessory)

Technical data

Ambient temperature	-40 ... +60 °C
Product temperature	-20 ... +60 °C
Average temperature coefficient of the zero signal	< 0.15 %/10 K
Longterm drift of the zero signal	< 0.1 %/2 years
Deviation in characteristic	0.2 %
Output signal	4 ... 20 mA
Operating voltage	9.6 ... 36 V DC
Nominal leak current (8/20 µs)	5 kA
Protection transmitter	IP 68

Material

Transmitter	316L
Diaphragm	sapphire-ceramic®
Measuring cell seal	FKM

Suspension cable PE

Configuration	two wires, breather capillaries, braiding
Wire cross-section	2 x 0.5 mm ²
Diameter	approx. 8 mm

You can find further information on our home page under www.vega-line.uk.

Net price per piece in GBP		407,00
Measuring range / Length PE suspension cable		
A	rel. / 0 ... 0.1 bar (0 ... 10 kPa) / 10 m	-
B	rel. / 0 ... 0.2 bar (0 ... 20 kPa) / 10 m	-
C	rel. / 0 ... 0.4 bar (0 ... 40 kPa) / 10 m	-
D	rel. / 0 ... 1.0 bar (0 ... 100 kPa) / 27 m	70,00
E	rel. / 0 ... 2,5 bar (0 ... 250 kPa) / 27 m	70,00

WELLS51.E

Accessory	Order number	Price in GBP
Closing screw G1 PN 3 / 316L	WLVSCHR.GC	47,00
Closing screw G1½ PN 3 / 316L	WLVSCHR.GA	47,00
Straining clamp / 304	2.27363	52,00
VEGABOX 02 (breather housing)	BOX02.XXAXX	64,00

VEGASWING S 51

Vibrating level switch for liquids

Application area

The VEGASWING S 51 is a universal liquid level switch with smallest dimensions. Independent of the mounting position it detects reliably and with millimetre precision the limit level. The instrument can be used as full or empty detector, as approved overfill, dry run or pump protection in vessels or pipelines.

The VEGASWING S 51 is an economical solution with maximum reliability and safety.



Your benefit

- Minimum time and cost expenditure through simple setup without medium
- Precise and reliable function through product-independent switching point
- Low maintenance costs

Function

The rugged stainless steel tuning fork is piezoelectrically energised and vibrates at its resonance frequency. The vibrating frequency changes if the tuning fork is covered by the liquid. The change is reliably detected by the integrated electronics module and converted into a switching signal. The switching condition is visible from outside via a two-colour LED. No special adjustments are required to set up VEGASWING S 51.

Electrical connection

View to the connection (instrument side)

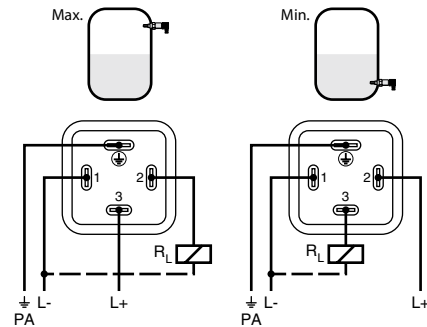

Version:
Electronics "T" (transistor) and
Electrical connection / Protection "V"

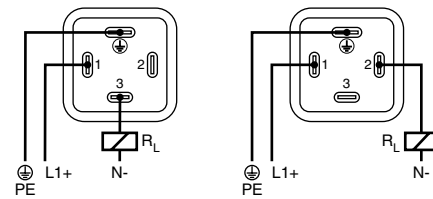

Version:
Electronics "C" (contactless electronic switch) and
Electrical connection / Protection "V"

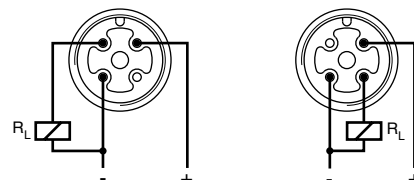

Version:
Electronics "T" (transistor) and
Electrical connection / Protection "M"

Dimensions

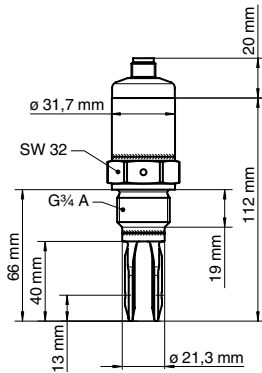

Version:
Electrical connection / Protection "M"

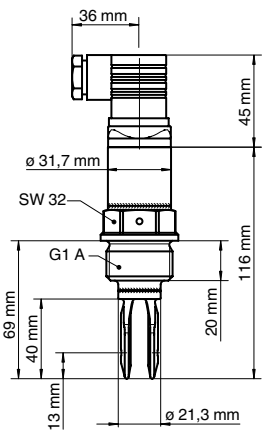

Version:
Electrical connection / Protection "V"

Technical data

Process pressure	-1 ... 64 bar
Process temperature	-40 ... +100 °C / -40 ... +150 °C
Density	≥ 0.7 g/cm ³
Viscosity	0.1 ... 10000 mPa s
Material, wetted-parts	316L
Material, housing	316L, plastic PEI
Switching delay	on: 0.5 s / off: 0.5 s
Approval	overflow protection according to WHG

Electronics transistor PNP (plug M12 x 1. plug DIN 43650)

Load current	max. 250 mA
Turn-on voltage	max. 55 V DC
Operating voltage	10 ... 55 V DC

Power consumption	max. 0.5 W
-------------------	------------

Electronics contactless electronic switch (plug DIN 43650)

Operating voltage	20 ... 253 V AC, 50/60 Hz, 20 ... 253 V DC
Domestic current requirement	approx. 3 mA (via the load circuit)
Load current	min. 10 mA, max. 250 mA

You can find further information on our home page under www.vega-line.uk.

Net price per piece in GBP		132,00
Process fitting / Process temperature		
1	Thread G $\frac{3}{4}$ PN 64 / -40 ... +100 °C	-
2	Thread G1 PN 64 / -40 ... +100 °C	-
5	Thread G $\frac{3}{4}$ PN 64 / -40 ... +150 °C	12,00
6	Thread G1 PN 64 / -40 ... +150 °C	17,00
Electronics		
C	Contactless electronic switch 20 ... 253 V AC/DC	-
T	Transistor PNP 10 ... 55 V DC	-
Electrical connection / Protection		
M	M12 x 1 / IP 66/IP 67 ¹⁾	-
V	according to DIN 43650 incl. plug / IP 65	-

SWINGS51.EEA

¹⁾ Only in conjunction with electronics "T"

	Order number	Price
Accessory		in GBP
Welded socket G $\frac{3}{4}$	ESTSG.1GBX1	89,00
Welded socket G1	ESTSG.1GAX1	89,00
M12 connection cable 4-pole length 5 m	ASL.2GA	15,00
Test magnet	2.28079	5,00

VEGASWING S 52

Vibrating level switch for liquids in the food and pharmaceutical industries

Application area

The VEGASWING S 52 is a universal level switch with smallest dimensions for liquids with hygienic requirements. Independent of the mounting position, it detects reliably and with millimetre precision the limit level. The instrument can be used as full or empty alarm, as approved overfill, dry run or pump protection in vessels and pipelines. The VEGASWING S 52 is an economical solution with maximum reliability and safety.

Your benefit

- Minimum time and cost expenditure through simple setup without medium
- Precise and reliable function through product-independent switching point
- Low costs for maintenance
- Perfectly suitable for CIP and SIP cleaning

Function

The rugged stainless steel tuning fork is piezoelectrically energised and vibrates at its resonance frequency. The vibrating frequency changes if the tuning fork is covered by the liquid. The change is reliably detected by the integrated electronics module and converted into a switching signal. The switching condition is visible from outside via a two-colour LED. No special adjustments are required to set up VEGASWING S 52.



Electrical connection

View to the connection (instrument side)

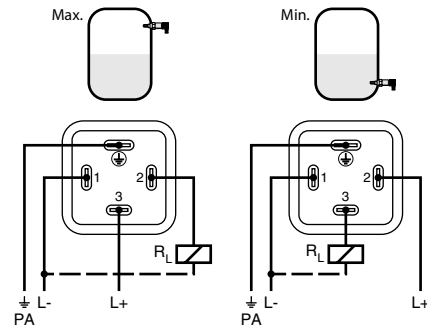

Version:

Electronics "T" (transistor) and
Electrical connection / Protection "V"

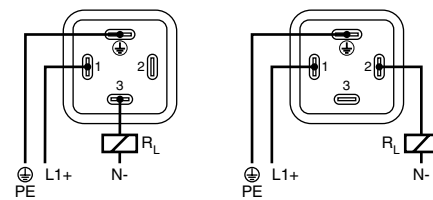

Version:

Electronics "C" (contactless electronics switch) and
Electrical connection / Protection "V"

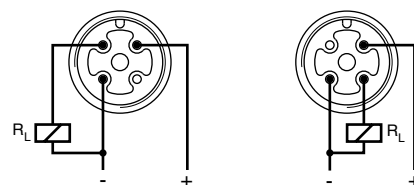

Version:

Electronics "T" (transistor) and
Electrical connection / Protection "M"

Dimensions

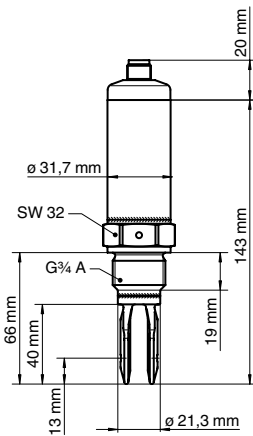

Version:
Process fitting „1“
Electrical connection / Protection „M“

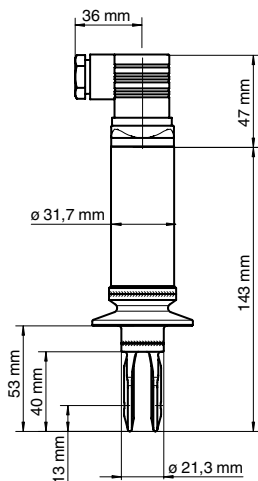

Version:
Process fitting "7"
Electrical connection / Protection "V"

Technical data

Process pressure	-1 ... 64 bar
Process temperature	-40 ... +150 °C
Density	≥ 0.7 g/cm ³
Viscosity	0.1 ... 10000 mPa s
Material, wetted-parts	316L (Ra < 0.8 µm)
Material, housing	316L, plastic PEI
Switching delay	on: 0.5 s / off: 0.5 s
Approval	overflow protection according to WHG

Electronics transistor PNP (plug M12 x 1. plug DIN 43650)

Load current	max. 250 mA
Turn-on voltage	max. 55 V DC
Operating voltage	10 ... 55 V DC
Power consumption	max. 0.5 W

Electronics contactless electronic switch (plug DIN 43650)

Operating voltage	20 ... 253 V AC, 50/60 Hz, 20 ... 253 V DC
Domestic current requirement	approx. 3 mA (via the load circuit)
Load current	min. 10 mA, max. 250 mA

You can find further information on our home page under www.vega-line.uk.

Net price per piece in GBP	204,00
Process fitting	
1 Thread G $\frac{3}{4}$ PN 64	-
2 Thread G1 PN 64	11,00
7 Clamp 1" PN 16	40,00
8 Clamp 2" PN 16	40,00
9 Bolting DN 40 PN 40 DIN 11851	40,00
Electronics	
C Contactless electronic switch 20 ... 253 V AC/DC	-
T Transistor PNP 10 ... 55 V DC	-
Electrical connection / Protection	
M M12 x 1 / IP 66/IP 67 ¹⁾	-
V according to DIN 43650 incl. plug / IP 65	-

SWINGS52.EEA

¹⁾ Only in conjunction with electronics "T"

Accessory	Order number	Price in GBP
Welded socket G $\frac{3}{4}$	ESTSG.1GBX1	89,00
Welded socket G1	ESTSG.1GAX1	89,00
Welded socket Clamp 1" incl. seal and tension ring	ESTC.A3SX	162,00
Welded socket Clamp 2" incl. seal and tension ring	ESTC.C3SX	165,00
Welded socket bolting DN 40 DIN 11851	ESTR.FAXX	95,00
M12 connection cable 4-pole length 5 m	ASL.2GA	15,00
Test magnet	2.28079	5,00

VEGAVIB S 61

Vibrating level switch for granulates

Application area

The VEGAVIB S 61 is a level switch for granules and coarse grained bulk solids. The VEGAVIB S 61 detects reliably and precisely the min. or max. limit level. The smooth surface of the vibrating rod, without corners and edges avoids jamming of the bulk solid and ensures optimum cleaning.

Your benefit

- Minimum time and cost expenditure through simple setup without medium
- Reliable function through product-independent switching point
- Low maintenance costs

Function

The vibrating rod of VEGAVIB is energized via piezoceramic elements. If the vibrating rod is covered by the product, the amplitude is damped. The amplitude change is processed by the integrated electronics module and converted into a switching command. The switching condition is visible from outside via a two-colour LED.

No special adjustments are required to set up VEGAVIB S 61.



Electrical connection

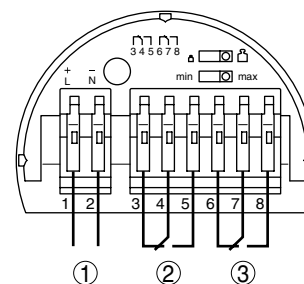

Version: Electronics "R" - Relay (DPDT)

- 1 Voltage supply
- 2 Relay 1
- 3 Relay 2

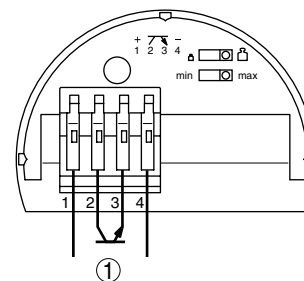

Version: Electronics "T" - Transistor (NPN/PNP)

- 1 Voltage supply

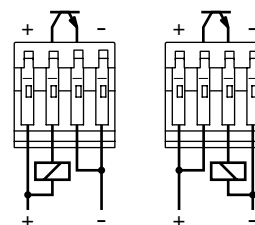

Assignment:

NPN

PNP

Dimensions

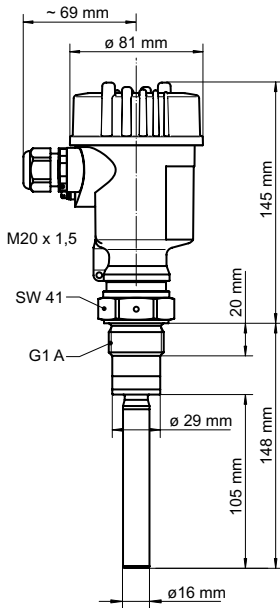

Version:
Sensor length „A“

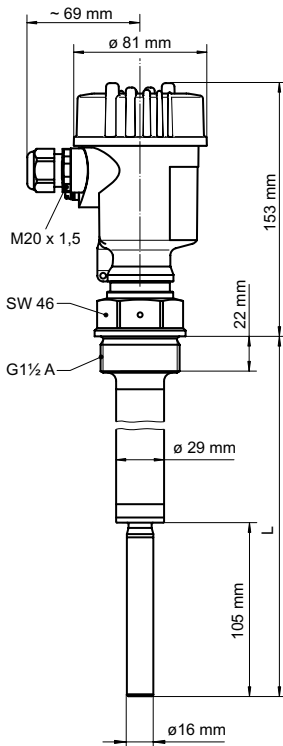

Version:
Sensor length "C", "D", "E"

Technical data

Process pressure	-1 ... 16 bar
Process temperature	-50 ... +150 °C
Density	≥ 100 g/l
Material, wetted-parts	316L
Material, housing	plastic PBT
Protection	IP 66/IP 67
Approval	option: ATEX II 1/3 D IP6X T
Electronics transistor (NPN/PNP)	
Load current	max. 400 mA
Turn-on voltage	max. 55 V DC
Operating voltage	10 ... 55 V DC
Power consumption	max. 0.5 W
Electronics relay (DPDT)	
Operating voltage	20 ... 253 V AC, 50/60 Hz, 20 ... 72 V DC
Power consumption	1 ... 8 VA (AC), approx. 1.3 W (DC)
Turn-on voltage	min. 10 mV / max. 253 V AC/DC
Switching current	min. 10 µA / max. 3 A AC, 1 A DC
Breaking capacity	max. 750 VA, 54 W

You can find further information on our home page under www.vega-line.uk.

Net price per piece in GBP		332,00
Approval		
XX	without	-
EJ	ATEX II 1/3 D IP6X T	77,00
Process fitting		
1	Thread G1 PN 16	-
2	Thread G1½ PN 16	25,00
Electronics		
R	Relay (DPDT) 20 ... 72 V DC/20 ... 253 V AC (5 A)	-
T	Transistor (NPN/PNP) 10 ... 55 V DC	-
Sensor length L		
A	148 mm	-
C	500 mm	91,00
D	1000 mm	182,00
E	1500 mm	271,00

VIBS61.E

Accessory	Order number	Price in GBP
Welding sleeve G1	2.36841	42,00
Welding sleeve G1½	2.36842	51,00
Lock fitting G1½ (unpressurized)	ARV-VB63.1GD	88,00
Lock fitting G1½ (-1 ... 16 bar)	ARV-VB63.2GD	185,00
PLICSLED Pluggable switching status display module plics® sensors Colour: yellow-green	PLICSLED.XXSYC	56,00
Colour: red-green	PLICSLED.XXSRC	56,00

VEGAWAVE S 61

Vibrating level switch for powders

Application area

The VEGAWAVE S 61 is a universal level switch for powders and fine-grained bulk solids. The VEGAWAVE S 61 detects reliably and precisely the min. and max. limit level. The tuning fork is ideal for the use in adhesive and abrasive products but also in bulk solids with very low density.

Your benefit

- Minimum time and cost expenditure through simple setup without medium
- Reliable function through product-independent switching point
- Low maintenance costs thanks to robust design

Function

The tuning fork of VEGAWAVE is energised via piezoceramic elements. If the tuning fork is covered by the medium, the amplitude is damped. The amplitude change is processed by the integrated electronics module and converted into a switching command. The switching condition is visible from outside via a two-colour LED.

No special adjustments are required to set up VEGAWAVE S 61.



Electrical connection

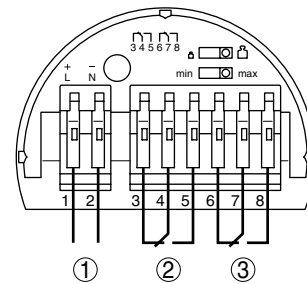

Version: Electronics "R" - Relay (DPDT)

- 1 Voltage supply
- 2 Relay 1
- 3 Relay 2

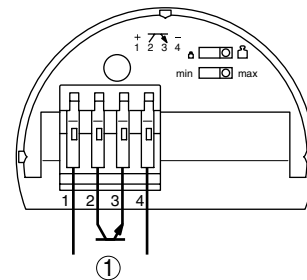

Version: Electronics "T" - Transistor (NPN/PNP)

- 1 Voltage supply

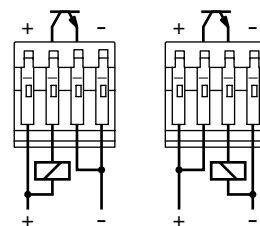

Assignment:

NPN

PNP

Dimensions

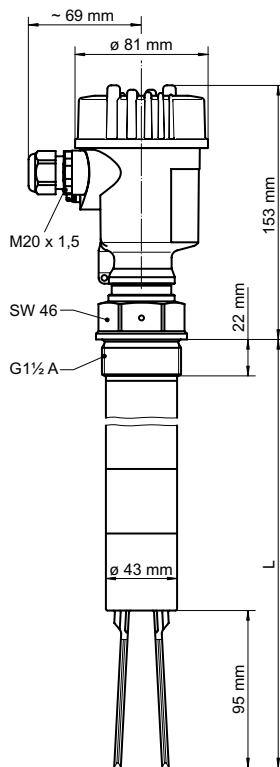

Technical data

Process pressure	-1 ... 25 bar
Process temperature	-50 ... +150 °C
Density	≥ 100 g/l
Material, wetted-parts	316L
Material, housing	plastic PBT
Protection	IP 66/IP 67
Approval	option: ATEX II 1/3 D IP6X T
Electronics transistor (NPN/PNP)	
Load current	max. 400 mA
Turn-on voltage	max. 55 V DC
Operating voltage	10 ... 55 V DC
Power consumption	max. 0.5 W
Electronics relay (DPDT)	
Operating voltage	20 ... 253 V AC, 50/60 Hz, 20 ... 72 V DC
Power consumption	1 ... 8 VA (AC), approx. 1.3 W (DC)
Turn-on voltage	min. 10 mV / max. 253 V AC/DC
Switching current	min. 10 µA / max. 3 A AC, 1 A DC
Breaking capacity	max. 750 VA, 54 W

You can find further information on our home page under www.vega-line.uk.

Net price per piece in GBP		269,00
Approval		
XX	without	-
EJ	ATEX II 1/3 D IP6X T	77,00
Process fitting		
2	Thread G1½ PN 25	-
Electronics		
R	Relay (DPDT) 20 ... 72 V DC/20 ... 253 V AC (5 A)	-
T	Transistor (NPN/PNP) 10 ... 55 V DC	-
Sensor length L		
A	165 mm	-
C	500 mm	91,00
D	1000 mm	182,00
E	1500 mm	271,00

WAVES61.E

Accessory	Order number	Price in GBP
Welding sleeve G1½	2.36842	51,00
Lock fitting G2 (unpressurized)	ARV-WE63.1GA	105,00
Lock fitting G2 (-1 ... 16 bar)	ARV-WE63.2GA	210,00
PLICSLED Pluggable switching status display module plics® sensors Colour: yellow-green Colour: red-green	PLICSLED.XXSYC PLICSLED.XXSRC	56,00 56,00

VEGABAR S 14

Process pressure transmitter with CERTEC® measuring cell

Application area

The VEGABAR S 14 is a universal pressure transmitter for the measurement of gases, vapours and liquids. The small pressure transmitter offers maximum reliability and safety. The VEGABAR S 14 is an economical solution for a number of applications in all industries.

Your benefit

- High plant availability through maximum overload and vacuum resistance of the ceramic measuring cell
- Price-favourable version with smallest mounting dimensions
- Low maintenance costs thanks to wear-free ceramic measuring cell

Function

The dry, ceramic measuring cell CERTEC® is implemented in VEGABAR S 14. The process pressure causes a capacitance change in the measuring cell via the ceramic diaphragm. This change is converted into a standardised 4 ... 20 mA signal.



Electrical connection

View to connection (instrument side)

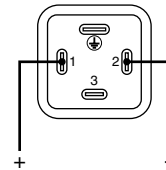

Version: Electrical connection "V"

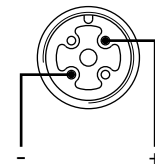

Version: Electrical connection "M"

Dimensions

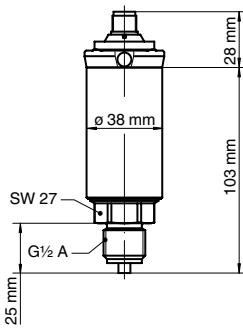

Version:
Electrical connection „M“

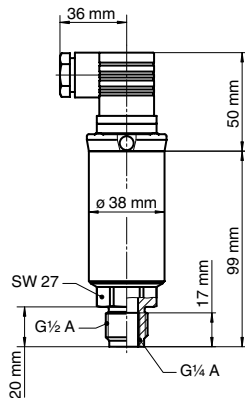

Version:
Electrical connection "V"

Technical data

Ambient temperature	-20 ... +85 °C
Product temperature	-20 ... +100 °C
Average temperature coefficient of the zero signal	< 0.15 %/10 K
Longterm drift of the zero signal	< 0.1 %/2 years
Deviation in characteristic	< 0.5 %
Output signal	4 ... 20 mA
Operating voltage	10 ... 30 V DC
Material, housing	brass nickle-plated / plastic PA
Protection	IP 65
Material, wetted parts	
Process fitting	316L
Diaphragm	sapphire-ceramic®
Process seal	FKM (Viton)

You can find further information on our home page under www.vega-line.uk.

Net price per piece in GBP		160,00
Process fitting		
1	G½, manometer connection EN 837 PN 60	-
2	G½, inner G¼, PN 60	-
Pressure / Measuring range		
A	rel. / 0 ... 0.1 bar (0 ... 10 kPa)	-
B	rel. / 0 ... 0.25 bar (0 ... 25 kPa)	-
C	rel. / 0 ... 0.4 bar (0 ... 40 kPa)	-
D	rel. / 0 ... 0.6 bar (0 ... 60 kPa)	-
E	rel. / 0 ... 1.0 bar (0 ... 100 kPa)	-
F	rel. / 0 ... 1.6 bar (0 ... 160 kPa)	-
G	rel. / 0 ... 4 bar (0 ... 400 kPa)	-
H	rel. / 0 ... 6 bar (0 ... 600 kPa)	-
K	rel. / 0 ... 10 bar (0 ... 1000 kPa)	-
L	rel. / 0 ... 16 bar (0 ... 1600 kPa)	-
M	rel. / 0 ... 25 bar (0 ... 2500 kPa)	-
P	abs. / 0 ... 10 bar (0 ... 1000 kPa)	-
Electrical connection		
M	M12 x 1	6,00
V	according to DIN 43650 incl. plug	-

BARS14.E

	Order number	Price in GBP
Accessory		
Welding sleeve G½	2.36839	18,00
Measuring instrument holder	BARMONT.D	102,00
M12 connection cable 4-pole length 5 m	ASL.2GA	15,00
Siphon U-form / 316	2.40129	119,00
Siphon circular form / 316	2.40130	123,00

VEGABAR S 16

Process pressure transmitter for liquids and gases in the food and pharmaceutical industries

Application area

The pressure transmitter VEGABAR S 16 can be used universally for the measurement of gases, vapours and liquids with hygienic requirements. The small pressure transmitter offers maximum reliability and safety. The front-flush mounting ensures optimum cleaning even with high hygienic requirements.

Your benefit

- High plant availability through maximum overload and vacuum resistance of the ceramic measuring cell
- Price-favourable version with smallest mounting dimensions
- Optimal for CIP and SIP cleaning

Function

The dry, ceramic measuring cell CERTEC® is used for VEGABAR S 16. The process pressure causes a capacitance change in the measuring cell via the ceramic diaphragm. This change is converted into a standardised 4 ... 20 mA signal.



Electrical connection

View to the connection (instrument side)

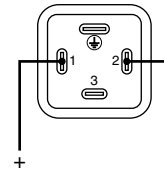

Version: Electrical connection "V"

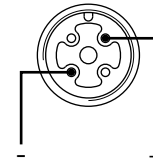

Version: Electrical connection "M"

Dimensions

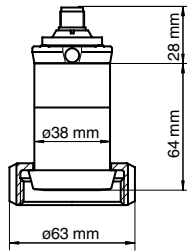

Version:
Process fitting „3“
Electrical connection „M“

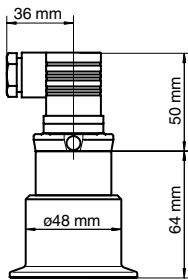

Version:
Process fitting "2"
Electrical connection "V"

Technical data

Ambient temperature	-20 ... +85 °C
Product temperature	-20 ... +100 °C
Average temperature coefficient of the zero signal	< 0.15 %/10 K
Longterm drift of the zero signal	< 0.1 %/1 years
Deviation in characteristic	< 0.5 %
Output signal	4 ... 20 mA
Operating voltage	10 ... 30 V DC
Material, housing	316L / plastic PA
Protection	IP 65
Material, wetted-parts	
Process fitting	316L
Diaphragm	sapphire-ceramic®
Process seal	EPDM

You can find further information on our home page under www.vega-line.uk.

Net price per piece in GBP		324,00
Process fitting		
1	Clamp 1" PN 16	-
2	Clamp 2" PN 16	-
3	Bolting DN 25 PN 40 DIN 11851	-
4	Bolting DN 40 PN 40 DIN 11851	-
Pressure / Measuring range		
A	rel. / 0 ... 0.1 bar (0 ... 10 kPa)	-
B	rel. / 0 ... 0.25 bar (0 ... 25 kPa)	-
C	rel. / 0 ... 0.4 bar (0 ... 40 kPa)	-
D	rel. / 0 ... 0.6 bar (0 ... 60 kPa)	-
E	rel. / 0 ... 1.0 bar (0 ... 100 kPa)	-
F	rel. / 0 ... 1.6 bar (0 ... 160 kPa)	-
G	rel. / 0 ... 4 bar (0 ... 400 kPa)	-
H	rel. / 0 ... 6 bar (0 ... 600 kPa)	-
K	rel. / 0 ... 10 bar (0 ... 1000 kPa)	-
L	rel. / 0 ... 16 bar (0 ... 1600 kPa)	-
N	abs. / 0 ... 2,5 bar (0 ... 250 kPa)	-
P	abs. / 0 ... 10 bar (0 ... 1000 kPa)	-
Electrical connection		
M	M12 x 1	8,00
V	according to DIN 43650 incl. plug	-

BARS16.E

Accessory	Order number	Price in GBP
Welded socket Clamp 1" incl. seal and tension ring	ESTC.A3SX	162,00
Welded socket Clamp 2" incl. seal and tension ring	ESTC.C3SX	165,00
Welded socket bolting DN 25	ESTR.DAXX	95,00
Welded socket bolting DN 40	ESTR.FAXX	95,00
M12 connection cable 4-pole length 5 m	ASL.2GA	15,00

This is how vega-line functions

Advice

Do you have questions about the vega-line products you need? Just give us a call. You can reach our experienced experts by dialing 01444 238856.

Order confirmation

Due to the speed of delivery, the invoice is also your order confirmation.

Prices

vega-line prices are net prices in GBP per item plus packaging, shipping and VAT 20% from 01.01.2012. If you order 4 instruments of the same type, you will get a 10% discount, from 10 instruments of the same type a 15% discount applies. This discount does not apply to accessory parts. The cost of packaging and shipping is £ 15.00 per consignment to UK mainland only. Any framework or purchasing agreements made with VEGA do not apply to vega-line product prices.

Shipment

All orders will be despatched next working day (excluding public holidays). This refers to orders of any 4 instruments of the same type. Higher quantities may require longer delivery. If this applies, we will advise you by return.



Warranty

The warranty period for vega-line products is 2 years. If an instrument fails due to any manufacturing defect within this period, you will get a replacement free of charge.

Specification & pricing

All prices are currently valid for UK from October 1st, 2015 to September 30th, 2016. However the description and price of the goods you order will be as shown on the vega-line website at the time you place your order. Furthermore, the sales, shipping and payment terms of VEGA Controls Ltd apply. We reserve the right to make commercial and technical modifications and changes to the product line at any time without notice. E&OE. For full terms and conditions, please see the website.

Direct sales vega-line

VEGA Controls Ltd.
Kendal House
Victoria Way
Burgess Hill
West Sussex
RH15 9NF

Phone 01444 238856
Fax 01444 870080
E-mail shop@vega-line.co.uk
www.vega-line.co.uk

Looking Forward **VEGA**