

THIS DOCUMENT IS SUBJECT TO CHANGE WITHOUT NOTICE. IT IS CONFIDENTIAL AND A PROPERTY OF Amphenol LTW. DISCLOSURE TO THIRD PARTY HAS TO BE AUTHORIZED BY Amphenol LTW.

REV.	ECN NO.	DATE	SIGN	DESCRIPTION
E	C201473	2020/09/23	Vicky	△E X4
F	C210024	2021/01/08	Vicky	△F X1
G	C210542	2021/02/17	Ruru	△G X5

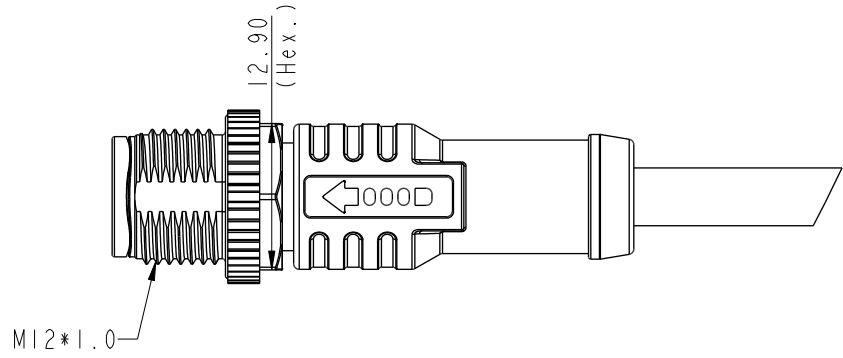
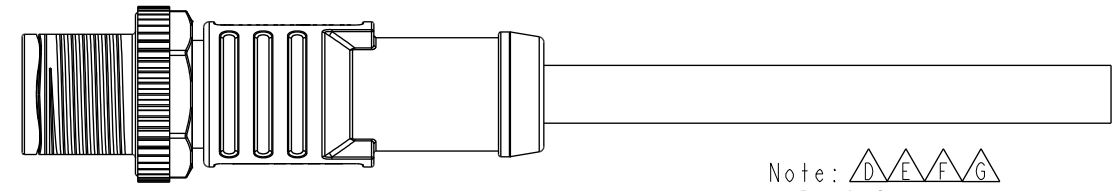
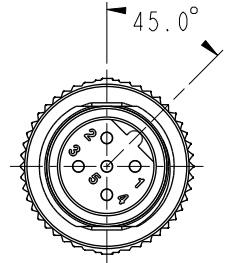
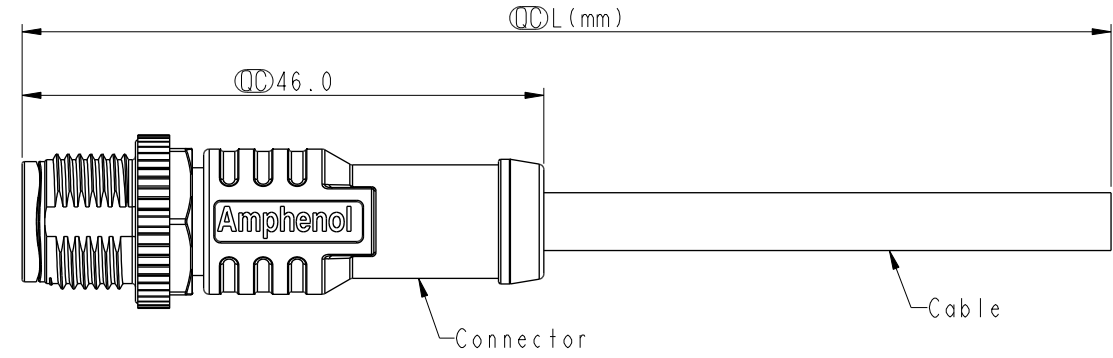

Note: △D △E △F △G

- * RoHS Compliant
- * ⌀ Important dimension
- * Waterproof rate: IPX8, mated 1m/24h
IPX9K, mated
- * Connector
 - Housing: Thermoplastic, Black
 - Pin: Copper alloy, Gold plated
 - Nut: Metal
 - Outer mold: Thermoplastic, Black
- * Cable: UL2517, PVC Jacket, Black
- * Cable length tolerance: LM: +50/-0 mm
 - 1M < L ≤ 3M: +100/-0 mm
 - 3M < L ≤ 5M: +150/-0 mm
 - 5M < L ≤ 10M: ±100 mm
 - 10M < L ≤ 20M: ±200 mm
 - 20M < L ≤ 30M: ±300 mm
 - 30M < L ≤ 99M: ±500 mm

UNIT: mm		
TOLERANCE		
±0.5mm		

TITLE N SEN, M12 B, SCREW CABLE W/O SR, M, M, MOLDING △G			
SCALE 3:2	SIZE A4	SHEET 1 OF 2	
REV. G	WC-REV. A.2	⌀: Inspection item	

Amphenol LTW
安費諾亮泰企業股份有限公司

ITEM NO.	DRAWN BY Ruru	DATE 2019-01-21
DWG NO. △E M12B-XXBMMM-SL8DXX	CHECKED BY Rita	DATE 2019-01-21
CUSTOMER ALTW	APPROVED BY Max	DATE 2019-01-21

THIS DOCUMENT IS SUBJECT TO CHANGE WITHOUT NOTICE. IT IS CONFIDENTIAL AND A PROPERTY OF Amphenol LTW. DISCLOSURE TO THIRD PARTY HAS TO BE AUTHORIZED BY Amphenol LTW.

	5P	5.1	22	MI2B-05BMMM-SL8DXX
	4P	4.8	22	MI2B-04BMMM-SL8DXX
Contacts	Cable OD	AWG	Item No.	

△B
△C
△G

△E

MI2B-XXBMMM-SL8DXX

XX: No. Of Pin

XX:01~99Meters
01:01Meter
02:02Meters
:
99:99Meters

△G

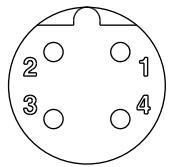
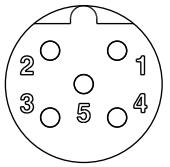
Pin Out	4	Black	黑	5	Gray	灰
	3	Blue	藍	4	Black	黑
	2	White	白	3	Blue	藍
	1	Brown	棕	2	White	白
				1	Brown	棕
	Pin #	Wire		Pin #	Wire	
Conn.						
	4P			5P		

Pin Assignments Front View

UNIT:mm	
TOLERANCE	±0.5mm

TITLE N SEN, MI2 B, SCREW CABLE W/O SR, M, M, MOLDING △E		
SCALE 3:2	SIZE A4	SHEET 2 OF 2
REV. G	WC-REV. A.2	QC: Inspection item

Amphenol LTW
安費諾亮泰企業股份有限公司

ITEM NO	DRAWN BY Ruru	DATE 2019-01-21
DWG NO △E MI2B-XXBMMM-SL8DXX	CHECKED BY Rita	DATE 2019-01-21
CUSTOMER ALTW	APPROVED BY Max	DATE 2019-01-21