

TECHNICAL CATALOGUE

Stainless steel enclosures for automation



Summary

Stainless steel enclosures for automation

INTRODUCTION

1

SRX ENCLOSURES

2

AMX MONOBLOC
CABINETS

3

ISX MODULAR
CABINETS

4

ACCESSORIES COMMON
TO ALL SERIES

5

IN-DEPTH TECHNICAL
INFORMATION

6

OVERALL DIMENSIONS

7

INDEX OF CODES

8

The ABB SACE website:

makes your work easier, develops your business

- News, to keep you up to date about the latest electrical engineering innovations
- Products, just a simple click for an overview of ABB SACE products 24 hours a day
- Catalogues that you can consult, download and request
- Technical documentation where you can check circuit diagrams, dimensional drawings,
- instruction sheets, installation manuals
- Work tools for designing in complete safety
- Training, where you can consult the training catalogue and register for courses online

www.new.abb.com/low-voltage

The ABB SACE website will help you in your daily work with an innovative approach to the world of low voltage electrical installations and industrial automation.



Technical software Calculation and cost estimate tools

e-Design: everyone has a project, ABB has a solution to make it happen.

e-Design is the integrated suite, designed and created by ABB, dedicated to designers, technicians, engineering companies, panel builders and wholesalers. Thanks to e-Design you can design an electrical installation and optimize the processing time, while benefiting from a product portfolio you can use in synergy and with intuitive and simple functions.

We would like to highlight several positive features:

- **Reliable in extreme conditions**
Thanks to the tests performed on the product, the enclosures can stand a rated short-time withstand current (I_{cw}) up to 150 kA and a Maximum rated current up to 6300A. The solution is also provided of an ant seismic certification, thanks to a shock level test up to 0.75 g performed with the installation of specific accessories. The safety is also guaranteed by the complete range of segregation forms up to 4b and by the blind tops arc fault resistant (composed by two flaps that, in case of internal arc fault, allow its outburst upward, protecting an operator that could be present in front of the switchboard).
- **Speed up your projects**
It is possible to save valuable time (up to 5% of the total time) by choosing the incoming column with DOC software, where a list of pre-configured incomer columns is already uploaded. Additional time can be saved thanks to the breaker kit package that with one single code provides all the components for a breaker kit installation (panel, plate, supports and screws); the pre-assembled DIN rail kit allows to save up to 70% on the time in case of System pro M components installation.
- **Space saving**
A wide variety of dimensions are available to meet all customer requests: 2 heights, 5 depths and 6 widths. Furthermore, amperage from 2500A to 6300A can be reached in the minimum widths listed below:
Up to 2500A (3P) installable in W=400mm
Up to 4000A (3P) installable in W=600mm
Up to 4000A (4P) installable in W=800mm
Up to 6300A (4P) installable in W=1000/1250mm
For example, further space (up to 38%) can be saved by mounting two air circuit breakers in one column in 2500A, width 400mm (E2.2 F/W 3P), thanks to the dedicated components.



- Simple and immediate selection and configuration of products, even for those who are not familiar
- with ABB products, simply by defining technical features
- The automatic user-friendly design process based on the list of devices simplifies one of the most
- complex design stages and avoids compatibility errors between products, assembly kits and busbar systems
- Effective product organization with tree views, so that the user can work methodically, view the relevant product immediately and define the switchboards with ease
- Availability of a dedicated module for busbar configuration

Well aware of market requirements, ABB now capitalizes on its experience and presents the new e-Design suite as a practical answer to every critical aspect of the design process.

e-Design suite is structured with integrated functional modules, allowing it to support all planning stages of an electrical installation.

All solutions are studied in detail, from electrical network dimensioning, to switchboard configuration, through to the final cost estimate stage.

The registration procedure is very easy and, once completed, you can immediately download installers and upgrades.

- DOC** Electrical installation Dimensioning
- EDS** Switchboard Configuration
- PDC** Switchboard Engineering
- CAT** Product Selection and Configuration

The suite's appealing and brandnew look, combined with general optimization of the functions that have always characterized ABB software, make it an innovative tool, up to date with the technologies currently available in the sector. After only a brief introduction, the user can already design, calculate, archive and perform project planning. No special CAD skills are required. Software operation is based on dialog boxes. The user is led through the program.

Chapter 1

Introduction

Introduction

Functionality, safety and hygiene are the core of this ABB cabinets range

The solution for specific applications in food, chemical and pharmaceutical sectors.

The ABB range of metal structures for automation was conceived and designed based on many years of experience working alongside the major switchboard and machine manufacturers in Italy and in the most industrialised and technological world markets.

Now, the range is enhanced with the new AISI 304 stainless steel structures, to guarantee all sectors requiring them high standards in terms of hygiene and corrosion resistance.

Performance complies with market requirements and guarantees high degrees of protection (IP66), NEMA 4X (UL Normative)* and strength (IK10 for metal structures with opaque door): these characteristics allow installation in most industrial environments in the reference sectors, such as the food industry in its various applications, the chemical sector and the pharmaceutical and hospital sector.

While the new ABB enclosures for automation are the most advanced currently available on the market, the stainless steel automation equipment is synonymous with technological innovation.

The stainless steel enclosures for automation are, of course, integrated with the various ABB control and operating apparatuses, all electrical values (dissipation, short-time withstand currents, insulation distances, etc.) and mechanical values have been analysed and checked by the manufacturer.

They also offer a high level of preparation for assembly of the apparatuses, with optimised hole drilling, fixings and overall dimensions. All of this to save you time and money!

In fact, stainless steel is suitable for the most diverse situations: temperature changes are no obstacle, nor is resistance to various types of external actions (heat sources and naked flames, UV rays, electromagnetic waves and other types of mechanical stresses).



* For SRX enclosures or AMX cabinets with single door.



Resistance to the corrosive action of external agents is guaranteed by the natural properties of stainless steel, making the metal structures suitable for installation outdoors and in special conditions.



Reliable in extreme conditions

Thanks to the special mechanical properties of stainless steel, this range of enclosures can be installed outdoors. It has high resistance to corrosion from harsh chemicals and cleaning solutions, so it can be easily sterilized as required for sanitary applications.



Easy to install

The enclosures are provided assembled with full compatibility with ABB components and accessories (back plates, DIN rail kit, 19" rack frame and so on).



The safety provided by a certified product

By law all products must conform both to European Directives and to the reference product Standards, but ABB goes further. We prefer an external organization to certify the quality of our products, especially regarding the more critical aspects both in technical and application terms.

All products in the stainless steel range are UL approved to also meet the requirements of markets where this mark is compulsory.

The technical characteristics and high degree of protection allow their use in standard industrial environments. In fact, the enclosures conform to the ATEX 99/92/EC and 94/9/EC Directive (suitable for use in zones 2 and 22).

Introduction

Functionality, safety and hygiene are the core of this ABB cabinets range

Thanks to years of experience ABB brings you the range of stainless steel cabinets and enclosures for automation, enhancing the range of sheet metal enclosures already available.

The ABB stainless steel range includes:

- AMX monobloc cabinets (with opaque door or glass door)
- ISX modular cabinets (with opaque door or glass door)
- SRX enclosures (with opaque door or glass door)

SRX enclosures always conform to IEC EN 62208 and to IEC 61439-1-2, have a degree of protection IP66 (IEC EN 60529) and NEMA 4X (UL standard). The degree of protection against external mechanical impacts is IK10 for the version with opaque door and IK09 for the version with glass door (IEC 62262). The AISI 304 stainless steel means that the cabinets can be fitted both indoors and outdoors, by fixing them to the floor or to a wall. AISI 304 stainless steel enclosures with opaque door, usually intended for making enclosures for automation, are supplied with the galvanised sheet

metal internal plate and do not have cable entry flanges. AISI 304 stainless steel enclosures with glass door can also be used for distribution configurations. Alternatively, the internal equipment is made by selecting special kits (Distribution Kit) consisting of a pair of functional uprights for assembly of the AISI 304 stainless steel modular panels (to be ordered separately) and any compensation panels.

The modular panels, which can also be installed on the enclosures with opaque door using the same KD Kit, are all hinged and have vertical modularity of 185 mm.

AMX monobloc cabinets have a degree of protection IP66 (IEC eN 60529) and NEMA 4X* (UL standard). Accessories for AMX monobloc cabinets, ISX modular cabinets and SRX enclosures include both AISI 304 stainless steel components and standard mountable code items also found in the current automation catalogue. For AMX monobloc cabinets, for example we supply: standard mounting plate, kit for recessing mounting plate, partial height mounting plate, side crosspieces H=100/48 mm, opposite mounting plate, DIN rails kit, opaque apparatus holder back plates, door anti-closure device, lifting eyebolts, horizontal partition panels, position switch, lamps, voltage detector devices, door reinforcement profiles, shaped sections for accessories, cable anchoring brackets and sliding rails.



* For SRX enclosures or AMX cabinets with single door. ISX IP66, Type 1,12 and AMX with double door IP66, Type 1

Thanks to its special corrosion resistance, AISI 304 stainless steel is suitable for use in environments requiring high standards of hygiene, for example in the food, chemical and pharmaceutical sectors.

ISX modular cabinets also conform to IEC EN 62208 and IEC 61439-1-2. The ISX range passed cabinet vibrations tests according to IEC 60068-2-57 and seismic tests according to IEE Std 693. ISX modular cabinets have a degree of protection IP65 (IEC EN 60529) and NEMA Type 1, 12 (UL standard).

The degree of protection against external mechanical impacts is IK10 for the version with opaque door and IK09 for the version with glass door (IEC 62262).

Available with opaque door or glass door, they have a structure with removable roof, complete with opaque door and rear panel, fixed cable entry flanges, plinth H=100 mm made up of four angular parts and can be completed with plinth flanges and side panels. Available in two heights, H=1800 mm and H=2000mm, with a double doors version (only opaque) with width W=1200 mm.

SRX enclosures can be equipped with: standard plates, clip nuts, spacers, slotted internal plate, accessories for stacking, DIN rails and fixing brackets, shaped sections for accessories on doors, closing systems. Accessories for AMX monobloc cabinets, ISX modular cabinets and SRX enclosures include both AISI 304 stainless

steel components and standard mountable code items also found in the current automation catalogue.

For AMX monobloc cabinets, for example we supply: standard mounting plate, kit for recessing mounting plate, partial height mounting plate, side crosspieces H=100/48 mm, opposite mounting plate, DIN rails kit, opaque apparatus holder back plates, door anti-closure device, lifting eyebolts, horizontal partition panels, position switch, lamps, voltage detector devices, door reinforcement profiles, shaped sections for accessories, cable anchoring brackets and sliding rails.

For ISX modular cabinets the following are available: horizontal reinforcement sections for door, folding shelves for door, door anticlosure device, standard back plate and relative recessing/joining/reinforcement kits, oversized back plate and relative joining/ reinforcement kits, tracks for plate lateral insertion, opposite mounting plate, partial back plate, crosspieces H=48/100 mm, crosspieces for base, transformer holder crosspieces, connector holder panel, vertical/horizontal partition panels, horizontal/vertical busbar segregations, DIN uprights, apparatus holder back plate, standard back plate for bench cabling, lifting eyebolts/brackets, lamps, voltage detector devices, position switch.

SRX enclosures can be equipped with: standard plates, clip nuts, spacers, slotted internal plate, accessories for stacking, DIN rails and fixing brackets, shaped sections for accessories on doors, closing systems.

Instruction manuals

Detailed multi-language instruction manuals, including drawings, show the correct way to assemble the structures and the components inside them. User compliance with manufacturer instructions allows the set-up of correctly selected and assembled electrical enclosures which conform to the new 61439-1-2 (CEI 17/13-1) in accordance with the European Community Low Voltage Directive (Directive 2006/95/EC which substitutes 73/23/EEC and subsequent amendments).



Chapter 2

SRX enclosures

2-2 General characteristics

2-8 Selection of the structure

2-10 Ordering codes

SRX enclosures

General characteristics and applications

The AISI 304 stainless steel used allows the cabinets to be installed either indoors or outdoors, by fixing to the floor or a wall.

AISI 304 stainless steel enclosures with opaque door, usually intended for making enclosures for automation, are supplied with the galvanised sheet metal internal plate and do not have cable entry flanges.

SRX enclosures always conform to IEC EN 62208 and to IEC 61439-1-2, have a degree of protection IP66 (IEC EN 60529); NEMA 4X and NEMA 3R (UL Standard).

The degree of protection against external mechanical impacts is IK10 for the version with opaque door and IK09 for the version with glass door (IEC 62262).

AISI 304 stainless steel enclosures with glass door can also be used for distribution configurations.

Alternatively, the internal equipment is made by selecting special kits (Distribution Kit) consisting of a pair of functional uprights for assembly of the AISI 304 stainless steel modular panels (to be ordered separately) and any compensation panels. The modular panels, which can also be installed on the enclosures with opaque door using the same KD Kit...X, are all hinged and have vertical modularity of 185 mm.



SRX enclosures can be equipped with: standard plates, clip nuts, spacers, slotted internal plate, accessories for stacking, DIN rails and fixing brackets, shaped sections for accessories on doors, closing systems.

—
01 Spray protection roof
 Improves protection against infiltration by liquids and accidental sprays. Made of AISI 304 stainless steel.



—
02 Distribution kit
 All apparatuses and modular circuit breakers can be installed on a DIN rail combined with a modular panel.





—
03 Stacking
 SRX enclosures can be stacked using the special kit. The plinth with removable flanges is made of 25/10 thick AISI 304 stainless steel.



—
04 Closing box
 A new Ø19mm closing box made of chrome-finished plastic with double tongue key.



Technical characteristics

Conforms to	CEI EN 62208, IEC 61439-1-2
Degree of protection	IP66 (CEI EN 60529) NEMA 3R (UL standard)
Degree of mechanical protection	IK10 opaque door IK09 glass door IEC 62262)
Certifications	 
Type of material	AISI 304
Installation site	indoors/outdoors
Fixing method	floor/wall
Normal operating conditions - ambient temperature	from -5 to +55°C

SRX enclosures

Selection of the structure

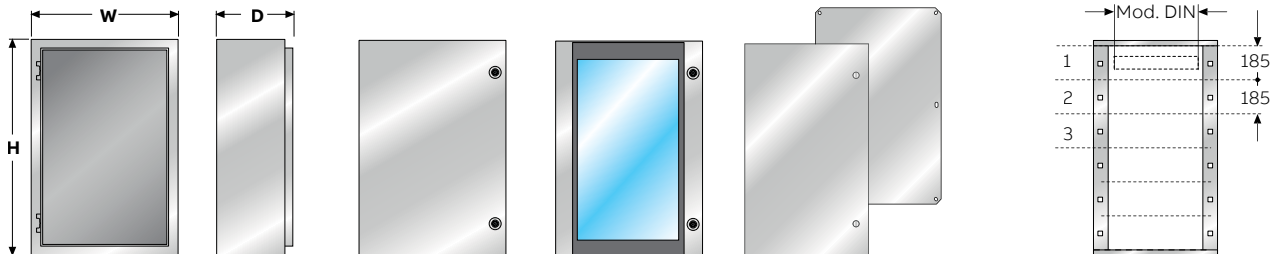

Overall dimensions			Automation kit				Distribution kit Supports for mounting modular panels							
H mm	W mm	D mm	Enclosures with opaque door + mounting plate	Enclosures with transparent door ¹	Opaque inner door IP20	Opaque plate	No. of vertical mod. H=185mm	No. of DIN mod. per row	Total modules	DIN supports				
300	200	150	SRN3215X			PF3020								
	400	150	SRN3415X			PF3040								
400	300	150	SRN4315X		KC4030X	PF4030								
		200	SRN4320X											
	400	200	SRN4420X			PF4040								
		600	200	SRN4620X		PF4060								
500	400	200	SRN5420X	SRN5420VX	KC5040X	PF5040	2	14	28	KD5040X				
	500	200	SRN5520X			PF5050								
600	400	200	SRN6420X	SRN6420VX	KC6040X	PF6040	3	14	42	KD6040X				
		600	200	SRN6620X							PF6060			
	600	300	SRN6630X											
700	500	250	SRN7525X	SRN7525VX	KC7050X	PF7050								
		200	SRN8620X								25	100		
	600	250		SRN8625VX	KC8060X	PF8060					4	25	100	KD8060X
		300	SRN8630X									25	100	
800	800	300	SRN8830X			PF8080								
		1000	800	300	SRN10830X	SRN10830VX	KC1080X	PF1080	5	36	180	KD1080X		
1200	600	300	SRN12630X			PF1260								
		800	300	SRN12830X			PF1280							

¹ Mounting plate to be ordered separately.

SRX enclosures

Ordering codes

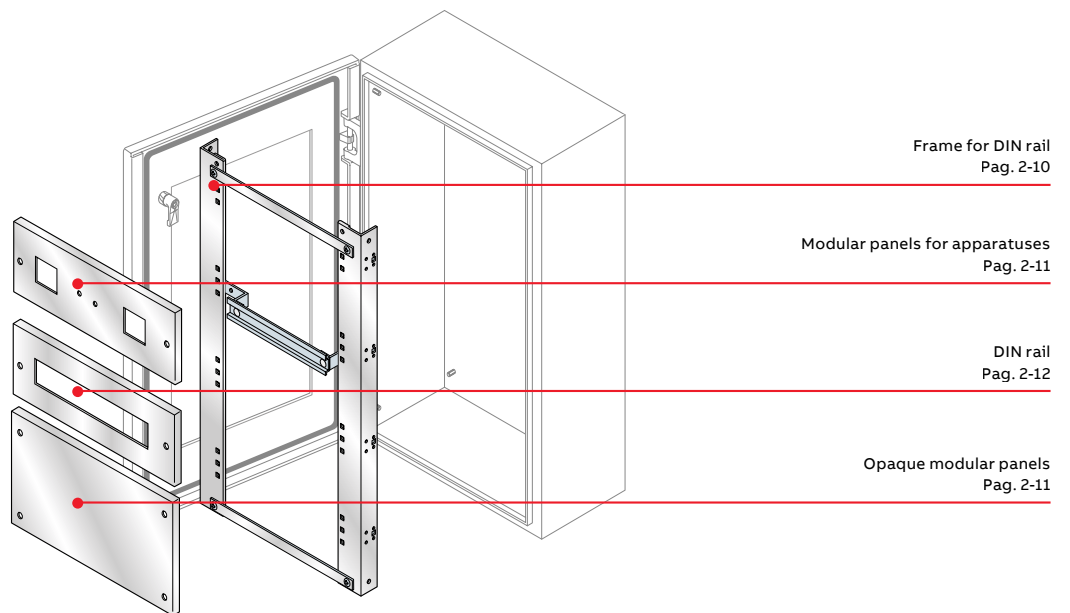
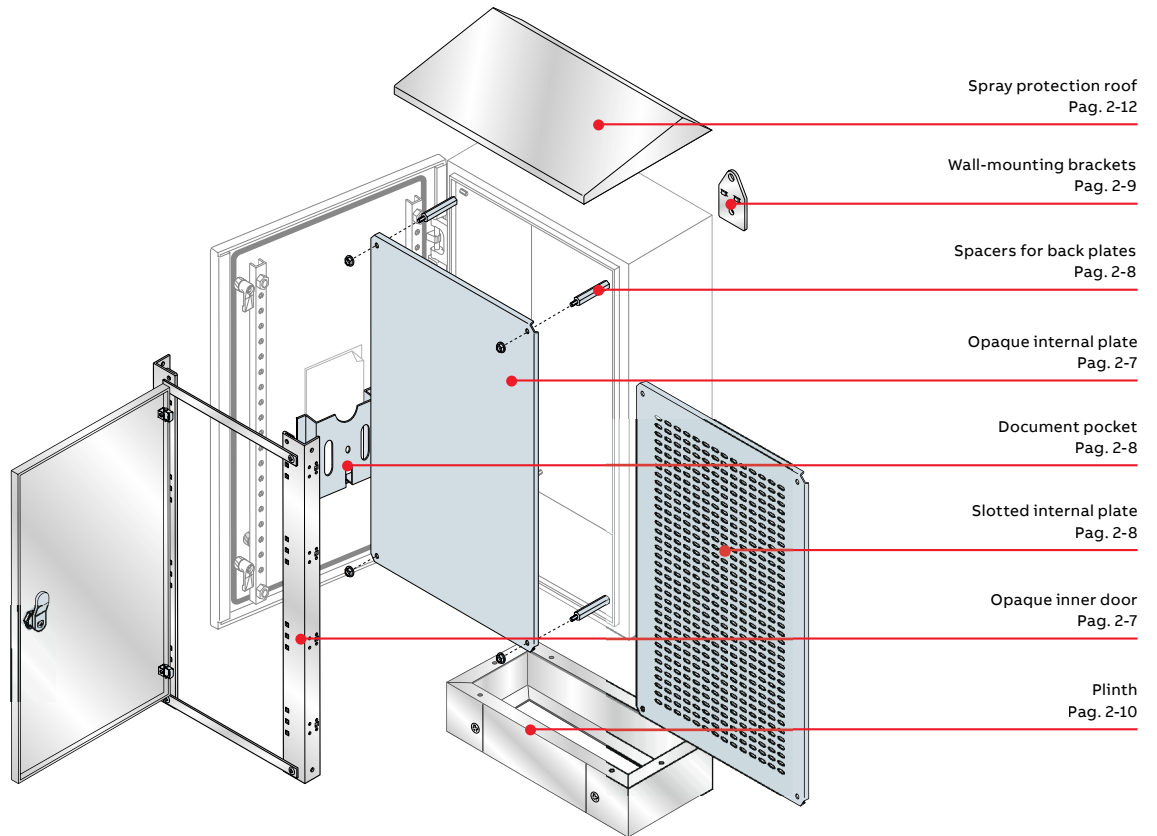

SRX enclosures

Ordering codes

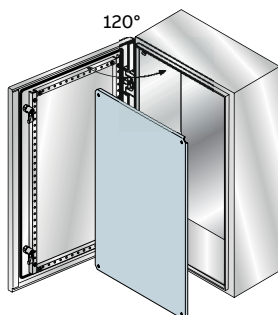

SRX series enclosures with opaque door (internal plate included)

Enclosures with an opaque door, made of AISI 304 stainless steel, usually intended for producing enclosures for automation, come supplied with the galvanised sheet metal internal plate and do not have cable entry flanges.

Dimensions (mm)			Type/ Order code	Pkg/ No. pcs
H	W	D		
Enclosures with opaque door complete with internal mounting plate				
300	200	150	SRN3215X	1/1
	400		SRN3415X	1/1
400	300	150	SRN4315X	1/1
	300	200	SRN4320X	1/1
	400		SRN4420X	1/1
500	600		SRN4620X	1/1
	400	200	SRN5420X	1/1
	500		SRN5520X	1/1
600	400	200	SRN6420X	1/1
	600		SRN6620X	1/1
	600	300	SRN6630X	1/1
700	500	250	SRN7525X	1/1
800	600	200	SRN8620X	1/1
	600	300	SRN8630X	1/1
	800		SRN8830X	1/1
1000	800	300	SRN10830X	1/1
1200	600	300	SRN12630X	1/1
	800		SRN12830X	1/1

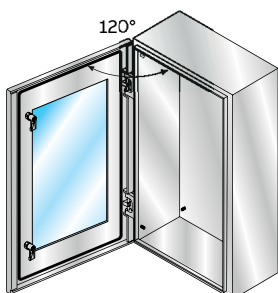

SRX series stainless steel enclosures with transparent door

AISI 304 stainless steel enclosures with a glass door can also be used for distribution configurations. The internal equipment is set up using the relevant kits:

- KD...X (Distribution Kit) consisting of a pair of functional uprights for assembly of the modular panels made of AISI 304 stainless steel (to be ordered separately) and of any compensation panels. The modular panels, which can also be installed on the enclosures with opaque door using the KD kit, are all hinged and have vertical modularity of 185 mm.

The enclosures with see-through door are provided without mounting plate.

Dimensions (mm)			Type/ Order code	Pkg/ No. pcs
H	W	D		
Enclosures with transparent door				
500	400	200	SRN5420VX	1/1
600	400		SRN6420VX	1/1
700	500	250	SRN7525VX	1/1
800	600		SRN8625VX	1/1
1000	800	300	SRN10830VX	1/1

SRX enclosures

Ordering codes

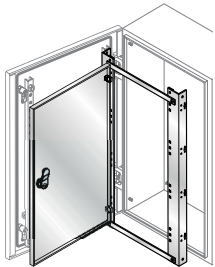

Opaque inner door

The inner door guarantees a degree of protection of IP20. Made of 15/10 thick AISI 304 stainless steel, complete with box and double tongue insert.

Dimensions (mm)		Type/ Order code	Pkg/ No. pcs
H	W		
Opaque inner door			
400	300	KC4030X	1/1
500	400	KC5040X	1/1
600		KC6040X	1/1
700	500	KC7050X	1/1
800	600	KC8060X	1/1
1000	800	KC1080X	1/1

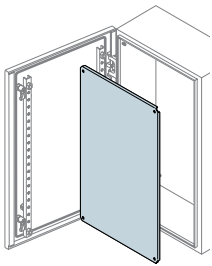

Opaque internal mounting plate

20/10 thick galvanised sheet metal internal plate, complete with fixing with small parts supplied. Depth-adjustable using a special spacer kit (to be ordered separately).

Dimensions (mm)		Type/ Order code	Pkg/ No. pcs
H	W		
Opaque internal mounting plate			
300	200	PF3020	1/1
300	400	PF3040	1/1
400	300	PF4030	1/1
400	400	PF4040	1/1
400	600	PF4060	1/1
500	400	PF5040	1/1
500	500	PF5050	1/1
600	400	PF6040	1/1
600	600	PF6060	1/1
700	500	PF7050	1/1
800	600	PF8060	1/1
800	800	PF8080	1/1
1000	800	PF1080	1/1
1200	600	PF1260	1/1
1200	800	PF1280	1/1

SRX enclosures

Ordering codes

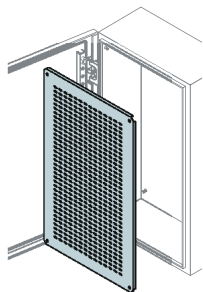

Slotted internal plate

Fixing with small parts supplied. Depth-adjustable using a special spacer kit (to be ordered separately).

Dimensions (mm)		Type/ Order code	Pkg/ No. pcs
H	W		
Piastra interna asolata			
300	200	TQ3020	1/1
300	400	TQ3040	1/1
400	300	TQ4030	1/1
400	400	TQ4040	1/1
400	600	TQ4060	1/1
500	400	TQ5040	1/1
600	400	TQ6040	1/1
600	600	TQ6060	1/1
700	500	TQ7050	1/1
800	600	TQ8060	1/1
800	800	TQ8080	1/1
1000	800	TQ1080	1/1
1200	600	TQ1260	1/1
1200	800	TQ1280	1/1

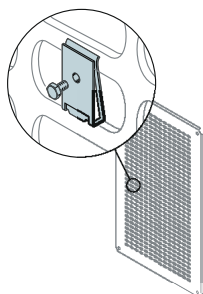

Clip nuts

For slotted plates with M6x10mm hexagonal head screws.

Description	Type/ Order code	Pkg/ No. pcs
Clip nuts	TQ6610	1/20

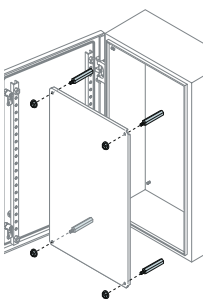

Spacer kit for adjusting back plate depth

Kit made up of 12 spacers for fixing the mounting plate. Allows depth adjustment in 25 mm steps.

Description	Type/ Order code	Pkg/ No. pcs
Spacers, length 25 mm	AA8025	1/12
Spacers, length 50 mm	AA8050	1/12

SRX enclosures

Ordering codes

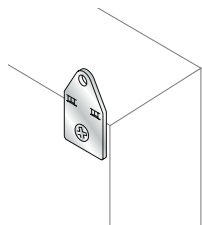

Wall-mounting brackets

Allow enclosures to be wall-mounted and are fitted using the special holes located on the back of the enclosures. Made of 30/10 thick AISI 304 stainless steel.

Description	Type/ Order code	Pkg/ No. pcs
No. 4 wall-mounting brackets	AA1206X	1/4

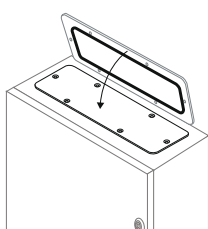

Fairlead plates

Fairlead plates in 25/10 thick AISI 304 stainless steel with polyurethane gasket.

Description	Dimensions (mm)		Type/ Order code	Pkg/ No. pcs
	W	D		
Fairlead plate for SRN3215X	200	150	FLN3215X	1/1
Fairlead plate for SRN4315X	300	150	FLN4315X	1/1
Fairlead plate for SRN3415X	400	150	FLN3415X	1/1
Fairlead plate for SRN4320X, SRN4320VX	300	200	FLN4320X	1/1
Fairlead plate for SRN4420X, SRN5420X, SRN6420X, SRN5420VX, SRN6420VX	400	200	FLN4420X	1/1
Fairlead plate 500x200mm for SRN5520X	500	200	FLN5520X	1/1
Fairlead plate for SRN4620X, SRN6620X, SRN8620X	600	200	FLN4620X	1/1
Fairlead plate for SRN8625VX	500	250	FLN7525X	1/1
Fairlead plate for SRN6630X, SRN8630X, SRN12630X	600	250	FLN8625X	1/1
Fairlead plate for SRN6630X, SRN8630X, SRN12630X	600	300	FLN6630X	1/1
Fairlead plate for SRN6830X, SRN8830X, SRN10830X, SRN12830X, SRN10830VX	800	300	FLN6830X	1/1

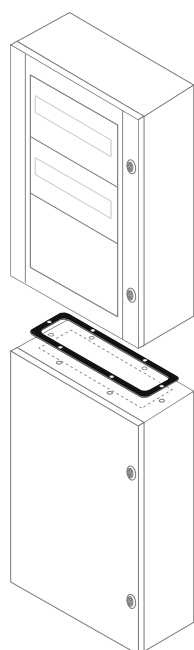

Accessories for stacking

Dimensions (mm)		Type/ Order code	Pkg/ No. pcs
W	D		
IP65 gasket			
400	200	GZ4020	1/1
500	200	GZ5020	1/1
	250	GZ5025	1/1
600	200	GZ6020	1/1
	250	GZ6025	1/1
	300	GZ6030	1/1
800	300	GZ8030	1/1

SRX enclosures

Ordering codes

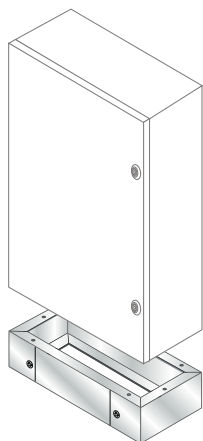

Plinth

25/10 thick AISI 304 stainless steel plinth.

Dimensions (mm)			Type/ Order code	Pkg/ No. pcs
H	W	D		
Plinth				
100	400	200	ZA4020X	1/1
100	500	200	ZA5020X	1/1
100		250	ZA5025X	1/1
100	600	200	ZA6020X	1/1
100		300	ZA6030X	1/1
100	800	300	ZA8030X	1/1

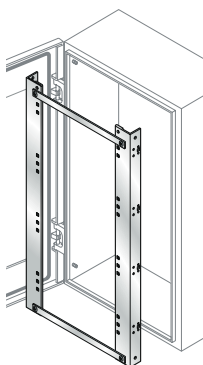

Frame for DIN rail

Internal supports for fixing modular panels and DIN rails, with compensation panels, made of AISI 304 stainless steel.

Description	Dimensions (mm)		Type/ Order code	Pkg/ No. pcs
	H	W		
Supports for 14 DIN mod. x 2 rows	500	400	KD5040X	1/1
Supports for 14 DIN mod. x 3 rows	600	400	KD6040X	1/1
Supports for 25 DIN mod. x 4 rows	800	600	KD8060X	1/1
Supports for 36 DIN mod. x 5 rows	1000	800	KD1080X	1/1

SRX enclosures

Ordering codes

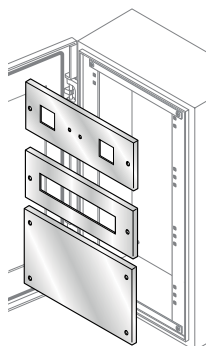

Screwed modular panels

12/10 mm thick AISI 304 stainless steel modular panels. The screwed modular panels can be fitted on the enclosures using the special kit (KD...) consisting of functional uprights and a compensation panel. Each modular panel (PM) comes equipped with a DIN rail (depth-adjustable), fixing brackets and the relative small parts. Tmax modular and moulded-case circuit breakers up to T3 can be positioned side by side on the same DIN rail using the special depth adapter AP 6001. To install MCCBs, fix the DIN rail in the recessed position. The DIN rail fixing brackets allow mounting of the wiring duct up to a maximum size of 60 x 60 mm.

Description	Dimensions (mm)		Type/ Order code	Pkg/ No. pcs
	H	W		
Stainless steel screwed modular panels for DIN rail (including DIN rail and fixing brackets)				
14 DIN mod. + fixing bracket	185	400	PM1414X	1/1
25 DIN mod. + fixing bracket	185	600	PM1625X	1/1
36 DIN mod. + fixing bracket	185	800	PM1836X	1/1
Stainless steel screwed modular panels for measuring instruments				
2 instruments 72 x 72mm	185	400	PS2476X	1/1
2 instruments 72 x 72mm	185	600	PS2676X	1/1
2 instruments 72 x 72mm	185	800	PS2876X	1/1
Stainless steel opaque screwed modular panels				
Opaque panel	185	400	PC1406X	1/1
Opaque panel	185	600	PC1606X	1/1
Opaque panel	185	800	PC1806X	1/1
Opaque panel	370	600	PC2606X	1/1
Opaque panel	370	800	PC2806X	1/1

Shaped sections for accessories

Allow fixing of accessories (e.g.: wiring ducts) inside the blind doors. Consist of a pair of vertical crosspieces made of 15/10 thick white galvanised sheet metal, pre-drilled with 25 mm pitch. In enclosures with height 1000 and 1200mm with a blind door, the shaped sections are already supplied.

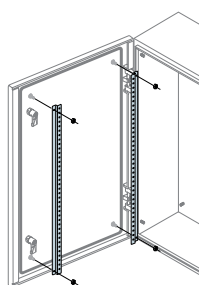

Description	Dimensions (mm)		Type/ Order code	Pkg/ No. pcs
	H	W		
Shaped sections for door	600		TS6009	1/1
Shaped sections for door	700		TS7009	1/1
Shaped sections for door	800		TS8009	1/1

SRX enclosures

Ordering codes

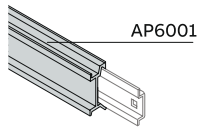
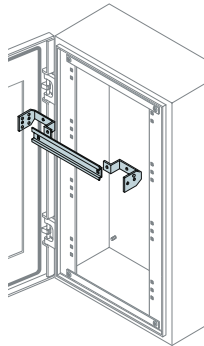

DIN rail and fixing brackets

Description	No. modules	W (mm)	Type/Order code	Pkg/No. pcs
DIN rail and fixing brackets	14	400	GD4006	1/1
DIN rail and fixing brackets	25	600	GD6006	1/1
DIN rail and fixing brackets	36	800	GD8006	1/1
Depth adapter				
No.1 depth adapter for Tmax T1-T2-T3-XT1-XT3		600	AP6001	1/4

Spray protection roof

Improves protection against infiltration by liquids and accidental sprays. Made of 15/10 thick AISI 304 stainless steel.

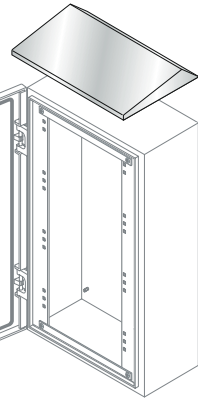

Description	Dimensions (mm)		Type/Order code	Pkg/No. pcs
	W	D		
Spray protection roof	200	150	TT2015X	1/1
Spray protection roof	300	150	TT3015X	1/1
Spray protection roof	400	150	TT4015X	1/1
Spray protection roof	300	200	TT3020X	1/1
Spray protection roof	400	200	TT4020X	1/1
Spray protection roof	500	200	TT5020X	1/1
Spray protection roof	600	200	TT6020X	1/1
Spray protection roof	500	250	TT5025X	1/1
Spray protection roof	600	250	TT6025X	1/1
Spray protection roof	600	300	TT6030X	1/1
Spray protection roof	800	300	TT8030X	1/1

Closing systems

May substitute standard fasteners for the external doors.

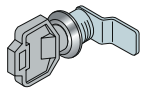

AA8001X

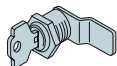

AA8002

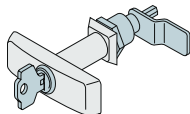

AA8003



EV1008

Description	Type/Order code	Pkg/No. pcs
Box Ø19mm double tongue made of chromefinished plastic and key for external door	AA8001X	1/1
Box Ø19mm with safety insert and Yale type key for external door	AA8002 ⁽¹⁾	1/1
Box Ø19mm with handle and Yale type key for external door	AA8003 ⁽¹⁾	1/1
Box Ø19mm with triangular insert for external door	AA5200 ⁽¹⁾	1/1
Plastic key for triangular insert AA5200 for external door	AA5190	1/1
Box without tongue insert made of plastic with key for inner door	EV1008	1/1
Single code Yale insert for inner door	EV1036	1/1
Ronis 455 insert for inner door	EV1037	1/1
3mm double tongue insert for inner door	EV1039	1/1

⁽¹⁾ Only for external door

SRX enclosures

Ordering codes

Special Drilling Service

The overprice amount depends on the number of individual drilled parts and not on the number of holes. For single part it means: A-door B-plate; C-housing; D-top/bottom part.

Please note that the minimum quantity is 10 pieces with a single code. The price of the special drilling service depends on the number of parts to be drilled and on the amount of enclosures to be drilled.

Description	Type/ Order code	Pkg/ No. pcs*
Extra cost for drilling service per individual drilled part (A-B-C-D)	FORSRX	≥ 10

* No. of enclosures to be drilled.

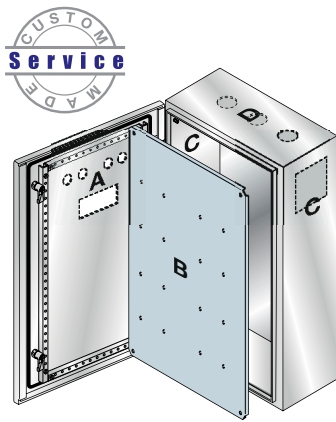

The special drilling service for standard size enclosures in quantities equal to or greater than 10 units with a single code has to be managed with code SRN ... SPEC + overprice FORSR/FORSR1/FORSSR2 (see table) equal to the number of enclosures and the number of parts to be drilled + hole layout to be attached to the order (see useful drilling areas, page 7-28)

Example: **SRN4320XSPEC 10**
FORSRX 10

Example: **Enclosure (10 pcs) with door and plate to be drilled (2 parts)**
SRN4320XSPEC 10
FORSRX 20
DRAWINGS TO BE ATTACHED

Non-standard enclosure sizes, special drilling

Request feasibility of implementation by completing the relevant Form for special quotations and send it together with the drill layout to the R&D ECS office. Management is per offer.

If the offer is accepted and after having received it, it will be possible to place the order with the codes indicated in the offer.



Painting Special Service

Request feasibility of implementation by completing the relevant Form for special quotations and send it to the R&D ECS office. Management is per offer. If the offer is accepted and after having received it, it will be possible to place the order with the codes indicated in the offer.

SRX enclosures

Ordering codes

Spare parts

Description	Type/ Order code	Pkg/ No. pcs
Stainless steel screws (No. 16 screws, flanged nuts and nylon washers M6)	AA1203X	1/1
Opaque door 300x200mm (HxW)	PRN3026X	1/1
Opaque door 300x400mm (HxW)	PRN3046X	1/1
Opaque door 400x300mm (HxW)	PRN4036X	1/1
Opaque door 400x400mm (HxW)	PRN4046X	1/1
Opaque door 400x600mm (HxW)	PRN4066X	1/1
Opaque door 500x400mm (HxW)	PRN5046X	1/1
Opaque door 500x500mm (HxW)	PRN5056X	1/1
Opaque door 600x400mm (HxW)	PRN6046X	1/1
Opaque door 600x600mm (HxW)	PRN6066X	1/1
Opaque door 600x800mm (HxW)	PRN6086X	1/1
Opaque door 700x500mm (HxW)	PRN7056X	1/1
Opaque door 800x600mm (HxW)	PRN8066X	1/1
Opaque door 800x800mm (HxW)	PRN8086X	1/1
Opaque door 1000x800mm (HxW)	PRN1086X	1/1
Opaque door 1200x600mm (HxW)	PRN1266X	1/1
Opaque door 1200x800mm (HxW)	PRN1286X	1/1
Glass door 400x300mm (HxW)	PTN4036X	1/1
Glass door 500x400mm (HxW)	PTN5046X	1/1
Glass door 600x400mm (HxW)	PTN6046X	1/1
Glass door 700x500mm (HxW)	PTN7056X	1/1
Glass door 800x600mm (HxW)	PTN8066X	1/1
Glass door 1000x800mm (HxW)	PTN1086X	1/1

Chapter 3

AMX monobloc cabinets

3-2 General characteristics and applications

3-4 Selection of the structure

3-6 Ordering codes

AMX monobloc cabinets

General characteristics and applications

The degree of mechanical protection against external impacts of AMX monobloc cabinets is IK10 for the version with blind door and IK09 for the version with glass door (IEC 62262).

AMX monobloc cabinets conform to IEC EN 62208 “Empty enclosures for low voltage switchgear and controlgear assemblies” and to IEC 61439-1-2 “Low-voltage switchgear and controlgear assemblies”, they have a degree of protection IP66 (IEC EN 60529) and NEMA 4X (UL standard)*.

The AISI 304 stainless steel allows the cabinets to be fitted both indoors and outdoors, by fixing them to the floor. Whether they have a blind door or a glass door, the cabinets feature an AISI 304 stainless steel monobloc structure complete with non-removable side panels and roof, built-up cable entry flanges, reversible blind door, rear panel, plinth H=100 mm made up of four angled parts.

The range is completed with plinth flanges, mounting plate or other internal equipment available.

The supply is completed with a set of standard accessories for producing automation or distribution enclosures, such as: standard mounting plate, kit for recessing mounting plate, partial height mounting plate, side crosspieces H=100/48 mm, opposite mounting plate, DIN rail kit, blind apparatus holder back plates, door anti-closure device, lifting eyebolts, horizontal partition panels, position switch, lamps, voltage detector devices, door reinforcement profiles, shaped sections for accessories, cable anchoring brackets and sliding rails.



* For AMX cabinets with single door. For AMX cabinets with double door IP66, Type 1

Accessories for AMX monobloc cabinets include both AISI 304 stainless steel components and standard mountable code items also found in the current automation catalogue.

—
01 Plinths

Plinths with removable flanges made of AISI 304 stainless steel, with a hole for fixing to the floor..

—
01





—
02 Cable entry flanges

20/10 thick stainless sheet steel flanges. Sliding, built-up and fixed types.

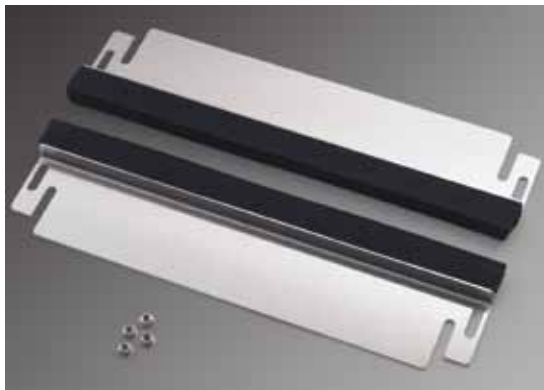
—
02



Technical characteristics

Conforms to	CEI EN 62208, IEC 61439-1-2
Degree of protection	IP66 (CEI EN 60529) NEMA 4X (UL standard)
Degree of mechanical protection	IK10 opaque door IK09 glass door (IEC 62262)
Certifications	 
Type of material	AISI 304
Installation site	indoors/outdoors
Fixing method	floor/wall
Normal operating conditions - ambient temperature	from -25 to +40°C

* For AMX cabinets with single door. For AMX cabinets with double door IP66, Type 1

AMX monobloc cabinets

Selection of the structure

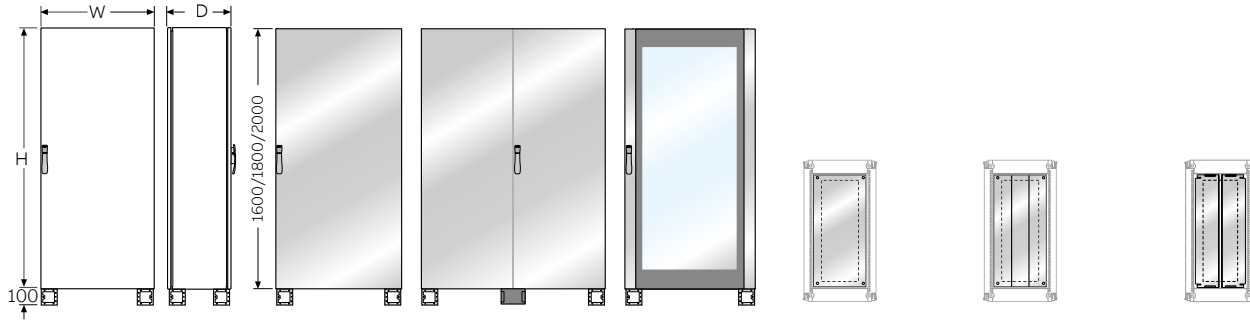

Overall dimensions			Cabinet with opaque door		Cabinet with glass door	Cable entry flanges			
H mm	W mm	D mm	Single opaque door	Double opaque doors overlapping closure	Single glass door	Fixed	Modular	Sliding	
1600	600	400	TM2664X			EF6045X	EF6044X	EF6040X	
	800	400	TM2684X			EF8045X	EF8044X	EF8040X	
1800	600	400	TM2864X		TM2864VX	EF6045X	EF6044X	EF6040X	
		500	TM2865X		TM2865VX	EF6055X	EF6054X	EF6050X	
	800	400	TM2884X		TM2884VX	EF8045X	EF8044X	EF8040X	
		500	TM2885X		TM2885VX	EF8055X	EF8054X	EF8050X	
	1000	400	TM2804X			EF1045X	EF1044X	EF1040X	
		500			TM2805VX	EF1055X	EF1054X	EF1053X	
1200	400		TM2824X			2xEF6045X	2xEF6044X	2xEF6040X	
	500		TM2825X			2xEF6055X	2xEF6054X	2xEF6050X	
2000	600	400	TM2964X			EF6045X	EF6044X	EF6040X	
		500	TM2965X		TM2965VX	EF6055X	EF6054X	EF8040X	
	800	400	TM2984X			EF8045X	EF8044X	EF8040X	
		500	TM2985X		TM2985VX	EF8055X	EF8054X	EF8050X	
	1000	400	TM2904X			EF1045X	EF1044X	EF1040X	
		500			TM2905VX	EF1055X	EF1054X	EF1053X	
	1200	400		TM2924X			2xEF6045X	2xEF6044X	2xEF6040X
		500		TM2925X			2xEF6055X	2xEF6054X	2xEF6050X

(*) The working height is always 100mm less than the external dimension of the enclosure to which the plinth dimension (H=100mm) must be added.

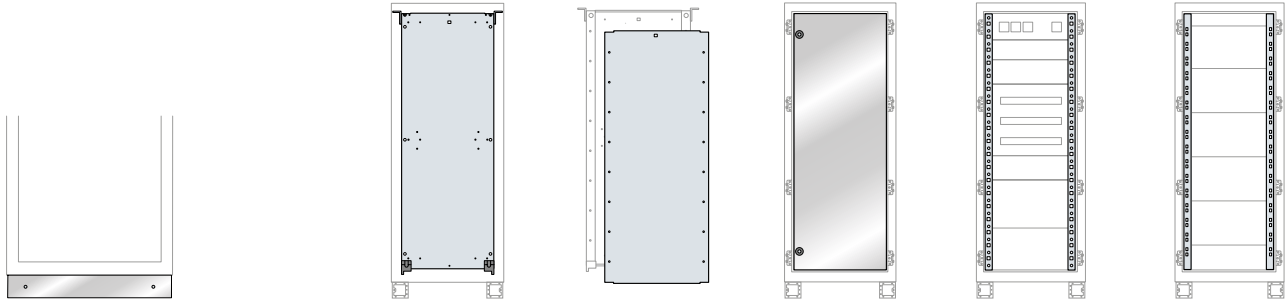

Plinth flanges		Galvanised sheet metal internal plates		Inner door	DIN rail uprights	19" rack frames
front/rear	side	Mounting plate	Opposite plate			
ZN6010X	ZN4011X	EA1616	EA5616	TF1660X	MD1600	TK1600
ZN8010X	ZN4011X	EA1619	EA5620	TF1680X		
ZN6010X	ZN4011X	EA1860	EA5861	TF1860X	MD1800	TK1800
ZN6010X	ZN5011X	EA1860	EA5861	TF1860X		
ZN8010X	ZN4011X	EA1880	EA5883	TF1880X		
ZN8010X	ZN5011X	EA1880	EA5883	TF1880X		
ZN1011X	ZN4011X	EA1810	EA5811	TF1810X		
ZN1011X	ZN5011X	EA1810	EA5811	TF1810X		
2xZN6010X	ZN4011X	EA1812			MD2000	TK2000
2xZN6010X	ZN5011X	EA1812				
ZN6010X	ZN4011X	EA2060	EA5063	TF2060X		
ZN6010X	ZN5011X	EA2060	EA5063	TF2060X		
ZN8010X	ZN4011X	EA2080	EA5083	TF2080X		
ZN8010X	ZN5011X	EA2080	EA5083	TF2080X		
ZN1011X	ZN4011X	EA2010	EA5011	TF2010X		
ZN1011X	ZN5011X	EA2010	EA5011	TF2010X		
2xZN6010X	ZN4011X	EA2012				
2xZN6010X	ZN5011X	EA2012				



AMX monobloc cabinets

Ordering codes

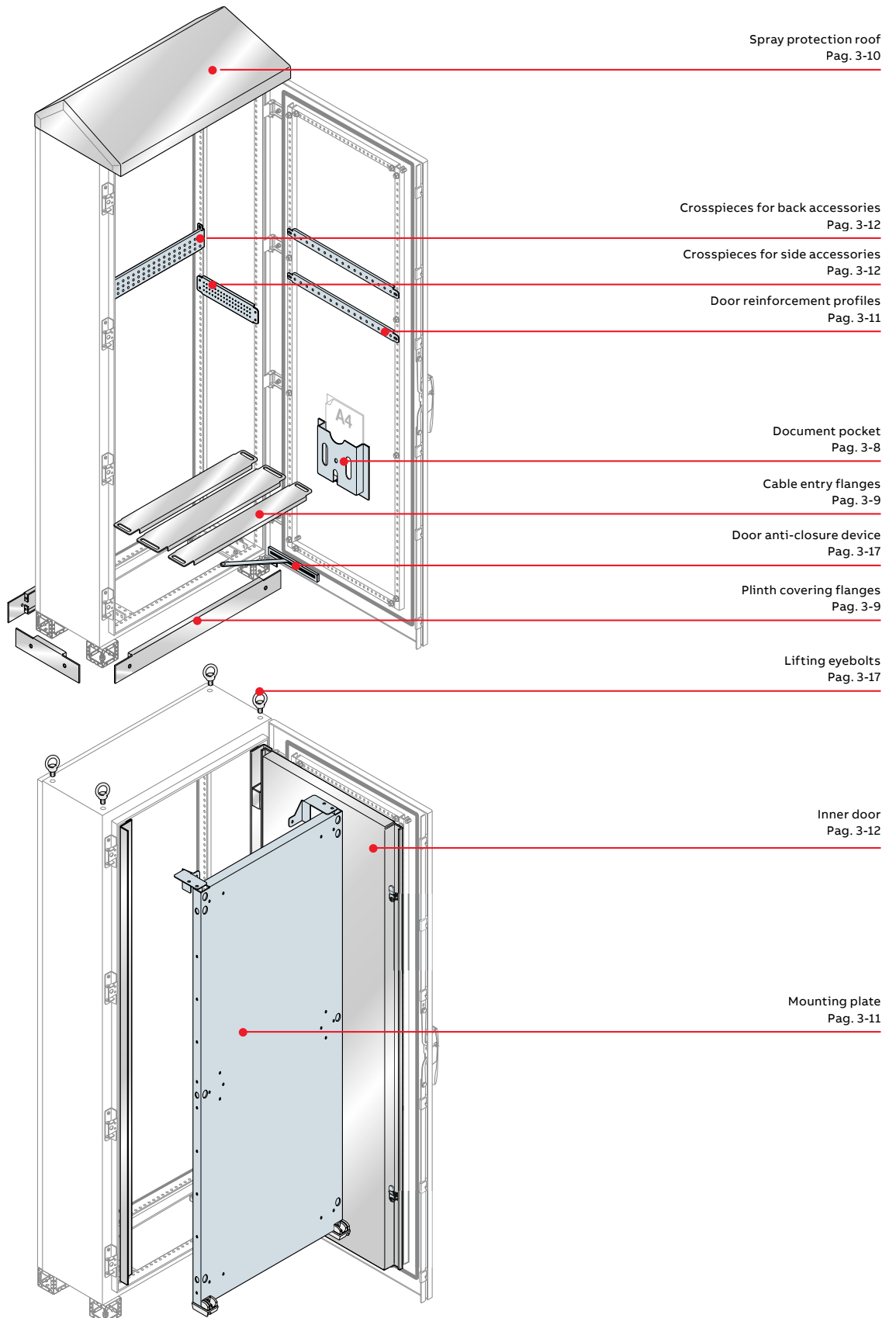

AMX monobloc cabinets

Ordering codes

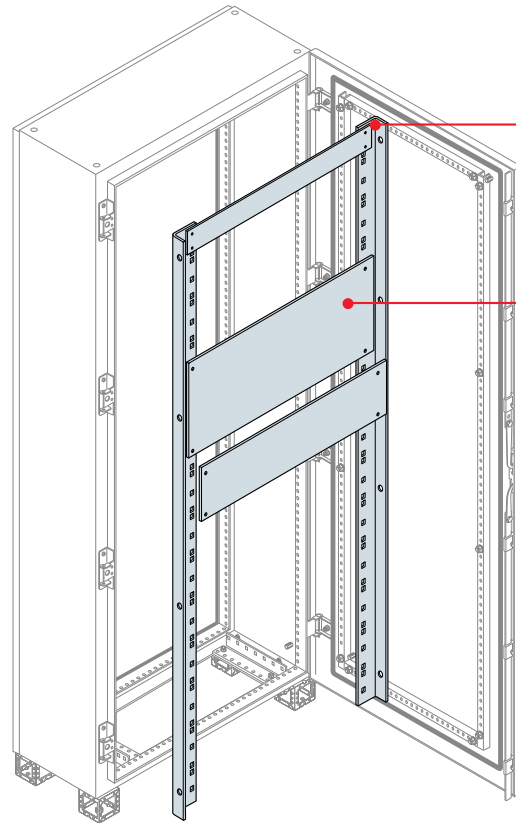

19" rack frame
Pag. 3-16

Blind compensation panels
Pag. 3-16

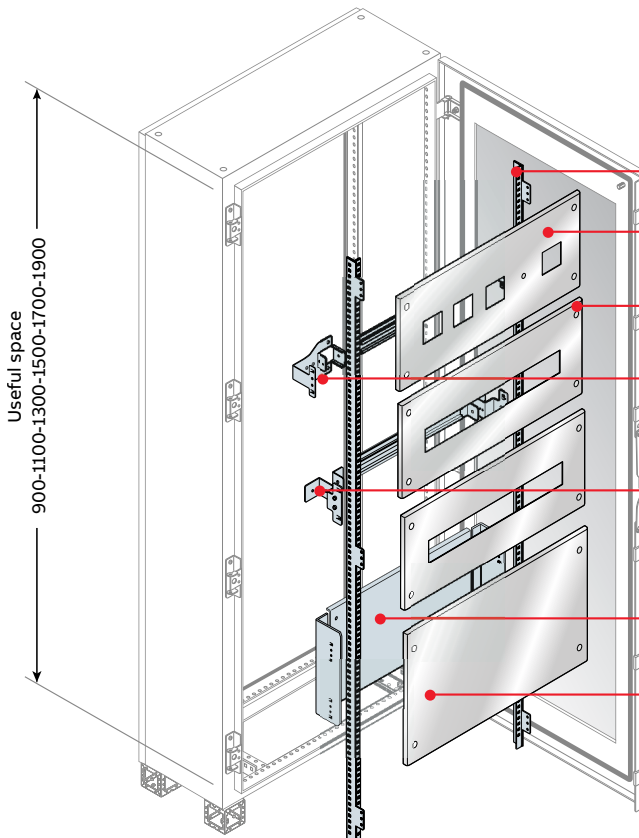

Useful space
900-1100-1300-1500-1700-1900

Uprights for DIN rail
Pag. 3-13

Panels for measuring instruments
Pag. 3-15

Panels for modular equipment
Pag. 3-15

DIN rail kit 18/29 mod.
Pag. 3-13

DIN rail kit 24/36 mod.
Pag. 3-13

Blind apparatus holder back plate
Pag. 3-15

Blind panels for apparatuses
Pag. 3-14

AMX monobloc cabinets

Ordering codes



Cabinets with opaque door

AISI 304 stainless steel monobloc structure, complete with non-removable side panels and roof, built-up cable entry flanges, reversible opaque door, rear panel, plinth H=100mm made up of four angular parts. To be completed with plinth flanges and mounting plate or other internal equipment.

Dimensions (mm)			Type/ Order code	Pkg/ No. pcs
H	W	D		
Cabinets with opaque door				
1600	600	400	TM2664X	1/1
	800	400	TM2684X	1/1
1800	600	400	TM2864X	1/1
		500	TM2865X	1/1
	800	400	TM2884X	1/1
		500	TM2885X	1/1
		400	TM2804X	1/1
	1200 ⁽¹⁾	400	TM2824X	1/1
	500	TM2825X	1/1	
2000	600	400	TM2964X	1/1
		500	TM2965X	1/1
	800	400	TM2984X	1/1
		500	TM2985X	1/1
	1000	400	TM2904X	1/1
	1200 ⁽¹⁾	400	TM2924X	1/1
	500	TM2925X	1/1	

⁽¹⁾ Version with double doors.

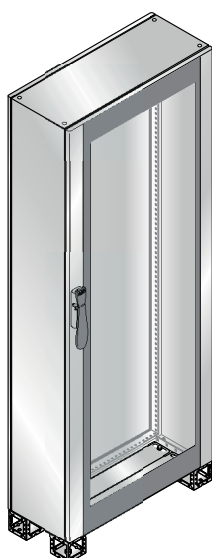

Cabinets with glass door

AISI 304 stainless steel monobloc structure complete with non-removable side panels and roof, built-up cable entry flanges, reversible glass door, rear panel, plinth H=100mm consisting of four angular parts. To be completed with plinth flanges and mounting plate or other internal equipment.

Dimensions (mm)			Type/ Order code	Pkg/ No. pcs
H	W	D		
Cabinets with glass door				
1800	600	400	TM2864VX	1/1
	800	400	TM2884VX	1/1
	600	500	TM2865VX	1/1
		500	TM2885VX	1/1
	1000	500	TM2805VX	1/1
2000	600	500	TM2965VX	1/1
	800	500	TM2985VX	1/1
	1000	500	TM2905VX	1/1

AMX monobloc cabinets

Ordering codes

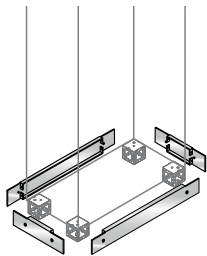

Plinth covering flanges

AISI 304 stainless steel removable flanges.

Description	Dimensions (mm)		Type/ Order code	Pkg/ No. pcs
	H	W		
Pair of flanges, front/back	100	600	ZN6010X	1/2
Pair of flanges, front/back		800	ZN8010X	1/2
Pair of flanges, front/back		1000	ZN1011X	1/2
Pair of side flanges	100	400	ZN4011X	1/2
Pair of side flanges		500	ZN5011X	1/2

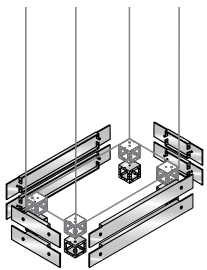

Additional plinth

To obtain a plinth 200mm high, order an angular parts kit H=100mm to be completed with 2 covering flanges H=100mm) for each side of the structure.

Description	Dimensions (mm)		Type	Order code	Pkg/ No. pcs
	H	W			
4 angular parts	100		ZN1010X		1/4

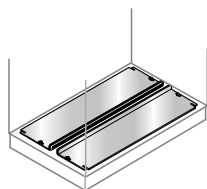

Cable entry flanges

20/10 stainless sheet steel flanges. Sliding, built-up and fixed type.

Description	Dimensions (mm)		Type/ Order code	Pkg/ No. pcs
	W	D		
Sliding cable entry flanges	600	400	EF6040X	1/1
Sliding cable entry flanges	800		EF8040X	1/1
Sliding cable entry flanges	1000		EF1040X	1/1
Sliding cable entry flanges	600	500	EF6050X	1/1
Sliding cable entry flanges	800		EF8050X	1/1
Sliding cable entry flanges	1000		EF1053X	1/1
Built-up cable entry flanges	600	400	EF6044X	1/1
Built-up cable entry flanges	800		EF8044X	1/1
Built-up cable entry flanges	1000		EF1044X	1/1
Built-up cable entry flanges	600	500	EF6054X	1/1
Built-up cable entry flanges	800		EF8054X	1/1
Built-up cable entry flanges	1000		EF1054X	1/1
Fixed cable entry flanges	600	400	EF6045X	1/1
Fixed cable entry flanges	800		EF8045X	1/1
Fixed cable entry flanges	1000		EF1045X	1/1
Fixed cable entry flanges	600	500	EF6055X	1/1
Fixed cable entry flanges	800		EF8055X	1/1
Fixed cable entry flanges	1000		EF1055X	1/1

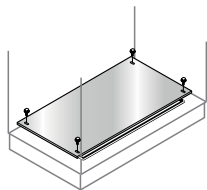
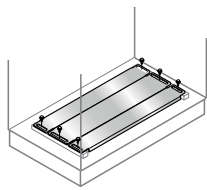

For structures with W=1200mm order 2 x parts with W=600mm.

AMX monobloc cabinets

Ordering codes

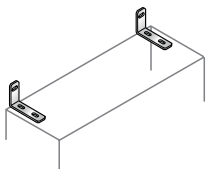

Wall-mounting brackets

For wall-mounting the more compact versions or versions designed for fixing to the floor.

Description	Type/ Order code	Pkg/ No. pcs
2 anti-tilting brackets	TA1207X	1/2

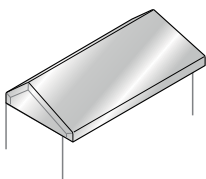

Spray protection roof

Improves protection against water sprays. Made of 15/10 stainless sheet steel.

Description	Dimensions (mm)		Type/ Order code	Pkg/ No. pcs
	W	D		
Spray protection roof	600	400	TP6040X	1/1
Spray protection roof	600	500	TP6050X	1/1
Spray protection roof	800	400	TP8040X	1/1
Spray protection roof	800	500	TP8050X	1/1
Spray protection roof	1000	400	TP1040X	1/1
Spray protection roof	1000	500	TP1050X	1/1
Spray protection roof	1200	400	TP1240X	1/1
Spray protection roof	1200	500	TP1250X	1/1

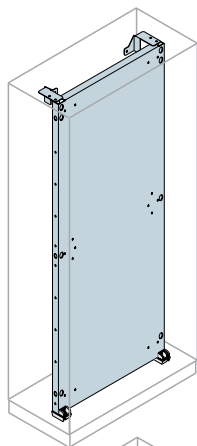

Standard mounting plates

25/10 galvanised steel plates which can be inserted from the front and/or rear. Complete with supports for sliding and fixing.

Description	Dimensions (mm)		Type/ Order code	Pkg/ No. pcs
	H	W		
Mounting plate	1600	600	EA1616	1/1
Mounting plate		800	EA1619	1/1
Mounting plate		1000	EA1610	1/1
Mounting plate		1200	EA1612	1/1
Mounting plate	1800	600	EA1860	1/1
Mounting plate		800	EA1880	1/1
Mounting plate		1000	EA1810	1/1
Mounting plate		1200	EA1812	1/1
Mounting plate	2000	600	EA2060	1/1
Mounting plate		800	EA2080	1/1
Mounting plate		1000	EA2010	1/1
Mounting plate		1200	EA2013	1/1

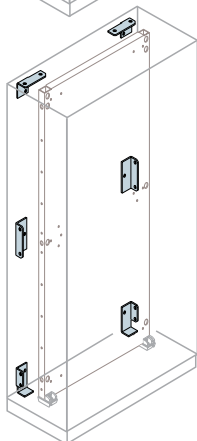

Kit for recessing mounting plates

Description	Type/ Order code	Pkg/ No. pcs
Kit for recessing mounting plate	EA5100	1/1

AMX monobloc cabinets

Ordering codes

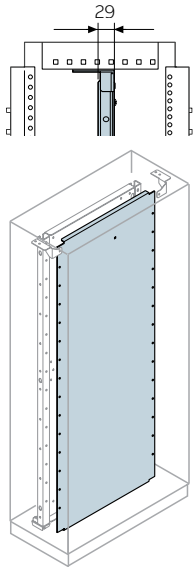

Opposite mounting plate

Mounting plate with extremely reduced overall dimensions in depth, able to mount components on both sides (front/rear). 25/10 galvanised steel plate which can be inserted from the front and/or rear depending on the cabinet width. Complete with support for sliding and fixing.

Description	Dimensions (mm)		Type/ Order code	Pkg/ No. pcs
	H	W		
Opposite plate	1600	600	EA5616	1/1
Opposite plate		800	EA5620	1/1
Opposite plate	1800	600	EA5861	1/1
Opposite plate		800	EA5883	1/1
Opposite plate		1000	EA5811	1/1
Opposite plate		1200	EA5822	1/1
Opposite plate	2000	600	EA5063	1/1
Opposite plate		800	EA5083	1/1
Opposite plate		1000	EA5011	1/1
Opposite plate		1200	EA5022	1/1

Reinforcements for opposite mounting plate

Description	Dimensions (mm)		Type/ Order code	Pkg/ No. pcs
	H	W		
2 reinforcements for opposite plate	1800		EA0018	1/2
2 reinforcements for opposite plate	2000		EA0020	1/2

For the mounting of the opposite mounting plate it is necessary to order also the standard mounting plate.

Partial height mounting plate

25/10 galvanised steel plate which can be inserted from the front and/or rear depending on the cabinet width. Fixed to the structure using the crosspieces H=48mm (TS....).

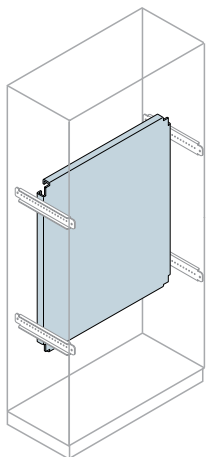

Description	Dimensions (mm)		Type/ Order code	Pkg/ No. pcs
	H	W		
Partial height mounting plate	200	600	EA2062	1/1
Partial height mounting plate	300		EA3061	1/1
Partial height mounting plate	400		EA4061	1/1
Partial height mounting plate	500		EA5061	1/1
Partial height mounting plate	600		EA6061	1/1
Partial height mounting plate	800		EA8061	1/1
Partial height mounting plate	1000		EA1061	1/1
Partial height mounting plate	200	800	EA2081	1/1
Partial height mounting plate	300		EA3081	1/1
Partial height mounting plate	400		EA4081	1/1
Partial height mounting plate	500		EA5081	1/1
Partial height mounting plate	600		EA6081	1/1
Partial height mounting plate	800		EA8081	1/1
Partial height mounting plate	1000		EA1081	1/1

AMX monobloc cabinets

Ordering codes

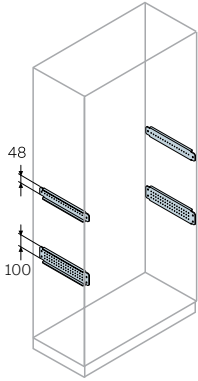

Side crosspieces for fixing accessories

Multi-purpose crosspieces made of drilled 20/10 thickness galvanised sheet metal. Round hole and square hole with 25mm pitch. Fitted on the side of the enclosure depending on the depth.

Description	Dimensions (mm)		Type/ Order code	Pkg/ No. pcs
	D			
No. 2 side crosspieces H=48mm	400		TS1004	1/2
No. 2 side crosspieces H=48mm	500		TS1005	1/2
No. 2 side crosspieces H=100mm	400		TS2004	1/2
No. 2 side crosspieces H=100mm	500		TS2005	1/2

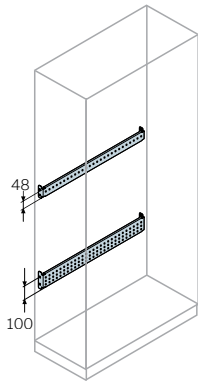

Back crosspieces for fixing accessories H=48/100mm

Multi-purpose crosspieces made of drilled 20/10 galvanised sheet metal. Round hole and square hole with 25mm pitch. Fitted on the back of the enclosure depending on the width.

Description	Dimensions (mm)		Type/ Order code	Pkg/ No. pcs
	W			
No. 2 back crosspieces H=48mm	600		EB0600	1/2
No. 2 back crosspieces H=48mm	800		EB0800	1/2
No. 2 back crosspieces H=48mm	1000		EB1000	1/2
No. 2 back crosspieces H=48mm	1200		EB1200	1/2
No. 2 back crosspieces H=100mm	600		EB0660	1/2
No. 2 back crosspieces H=100mm	800		EB0880	1/2
No. 2 back crosspieces H=100mm	1000		EB1010	1/2
No. 2 back crosspieces H=100mm	1200		EB1020	1/2

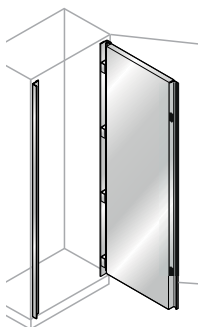

Inner doors

Internal door made of 15/10 thick stainless sheet steel, complete with reinforcement tube, frame, hinge and 2 boxes with double tongue key. Only for single door versions.

Description	Dimensions (mm)		Type/ Order code	Pkg/ No. pcs
	H	W		
Internal doors	1600	600	TF1660X	1/1
Internal doors		800	TF1680X	1/1
Internal doors	1800	600	TF1860X	1/1
Internal doors		800	TF1880X	1/1
Internal doors		1000	TF1810X	1/1
Internal doors	2000	600	TF2060X	1/1
Internal doors		800	TF2080X	1/1
Internal doors		1000	TF2010X	1/1

AMX monobloc cabinets

Ordering codes

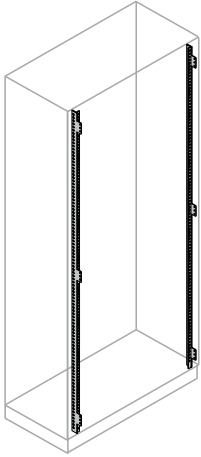

DIN rail panel

The fixed uprights are made of 20/10 thick galvanised steel and are fixed to the front of the structure. Structures 600 and 800mm wide can be fitted with the uprights.

Description	Dimensions (mm)		Type/ Order code	Pkg/ No. pcs
	H			
No. 2 panels for DIN rail	1600		MD1600	1/2
No. 2 panels for DIN rail	1800		MD1800	1/2
No. 2 panels for DIN rail	2000		MD2000	1/2

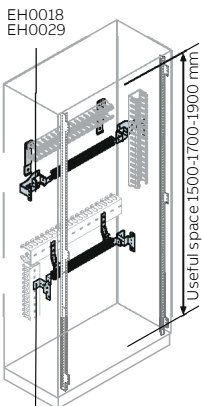

DIN rail kit and supports for fixing duct

Kit consisting of a double aluminium section (DIN 35), complete with shaped brackets for fixing wiring ducts. Fixed directly on the uprights MD1800 or MD2000. The working dimension is always 100mm less than the total height of the enclosure.

Description	Dimensions (mm)		Type/ Order code	Pkg/ No. pcs
	W	H		
DIN rail kit complete with supports for fixing front duct (maximum 60x80mm)				
18 DIN modules	600		EH0018	1/1
29 DIN modules	800		EH0029	1/1
DIN rail kit complete with supports for fixing rear duct (side ≥40mm)				
24 DIN modules	600		EH0024	1/1
36 DIN modules	800		EH0036	1/1
Supports for horizontal duct				
No. 4 plastic supports			AD1009	1/4
No. 4 plastic supports			AD1037	1/4
Depth adapter				
For XT1 and XT3 W=600mm			AP6000	1/4

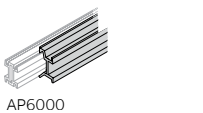
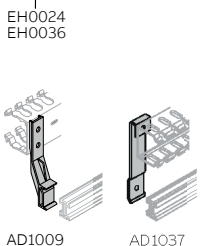

AMX monobloc cabinets

Ordering codes

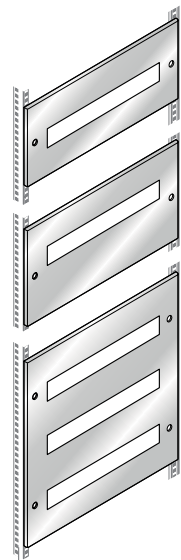

MD1600
MD1800
MD2000

Panels for modular apparatuses

12/10 stainless steel panel with modular cut-out. The working dimension of the enclosure is always 100mm less than the total height of the enclosure.

Description	Dimensions (mm)		Type/ Order code	Pkg/ No. pcs
	H	W		
Panel, 18 DIN mod.	150	600	EH1518X	1/1
	200		EH2018X	1/1
Panel, 18 DIN mod. eccentric	300		EH3018X	1/1
Panel, 54 DIN mod. (3 rows x 18 mod.)	600		EH6018X	1/1
Panel, 29 DIN mod.	150	800	EH1529X	1/1
	200		EH2029X	1/1
Panel, 29 DIN mod. eccentric	300		EH3029X	1/1
Panel, 87 DIN mod. (3 rows x 29 mod.)	600		EH6029X	1/1
Panel, 24 DIN mod.	150	600	EH1524X	1/1
	200		EH2024X	1/1
Panel, 72 DIN mod. (3 rows x 24 mod.)	600		EH6025X	1/1
Panel, 36 DIN mod.	150	800	EH1536X	1/1
	200		EH2036X	1/1
Panel, 108 DIN mod. (3 rows x 36 mod.)	600		EH6036X	1/1

Tmax XT cover plate for DIN rail

Description	Type/ Order code	Pkg/ No. pcs
Cover plate for Tmax XT1 3P mounted on DIN rail	AD3301	1/1
Cover plate for Tmax XT1 4P mounted on DIN rail	AD3302	1/1
Cover plate for Tmax XT3 3P mounted on DIN rail	AD3303	1/1
Cover plate for Tmax XT3 4P mounted on DIN rail	AD3304	1/1

Blind panels for apparatuses

12/10 stainless steel blind panel. The working dimension of the enclosure is always 100mm less than the total height of the enclosure.

Description	Dimensions (mm)		Type/ Order code	Pkg/ No. pcs
	H	W		
Blind panel	50	600	EH0562X	1/1
Blind panel	100		EH1062X	1/1
Blind panel	150		EH1562X	1/1
Blind panel	200		EH2062X	1/1
Blind panel	300		EH3063X	1/1
Blind panel	400		EH4062X	1/1
Blind panel	500		EH5062X	1/1
Blind panel	600		EH6062X	1/1
Blind panel	50	800	EH0582X	1/1
Blind panel	100		EH1082X	1/1
Blind panel	150		EH1582X	1/1
Blind panel	200		EH2082X	1/1
Blind panel	300		EH3082X	1/1
Blind panel	400		EH4082X	1/1
Blind panel	500		EH5082X	1/1
Blind panel	600		EH6082X	1/1

MD1600
MD1800
MD2000

AMX monobloc cabinets

Ordering codes

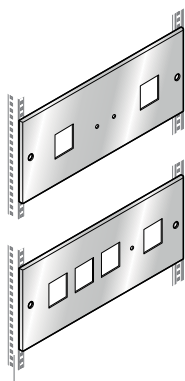

MD1600
MD1800
MD2000

Panels for square measuring instruments

12/10 stainless steel panel with cut-outs for measuring instruments. The working dimension of the enclosure is always 100mm less than the total height of the enclosure.

Description	Dimensions (mm)		Type/ Order code	Pkg/ No. pcs
	H	W		
Panel for 2 instruments 72x72mm	200	600	EH2272X	1/1
Panel for 4 instruments 72x72mm	200		EH2472X	1/1
Panel for 2 instruments 96x96mm	200		EH2297X	1/1
Panel for 2 instruments 72x72mm	200	800	EH3272X	1/1
Panel for 2 instruments 96x96mm	200		EH3296X	1/1
Panel for 4 instruments 72x72mm	200		EH3472X	1/1
Panel for 4 instruments 96x96mm	200		EH3496X	1/1

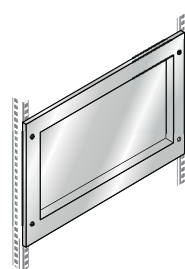

MD1600
MD1800
MD2000

Recessed opaque panels

15/10 stainless steel opaque panel. The working dimension of the enclosure is always 100mm less than the total height of the enclosure.

Description	Dimensions (mm)		Type/ Order code	Pkg/ No. pcs
	H	W		
Recessed opaque panel	200	600	EH2063X	1/1
Recessed opaque panel		800	EH2083X	1/1
Recessed opaque panel	300	600	EH3064X	1/1
Recessed opaque panel		800	EH3083X	1/1
Recessed opaque panel	400	600	EH4064X	1/1
Recessed opaque panel		800	EH4083X	1/1
Recessed opaque panel	500	600	EH5063X	1/1
Recessed opaque panel		800	EH5084X	1/1
Recessed opaque panel	600	600	EH6063X	1/1
Recessed opaque panel		800	EH6084X	1/1

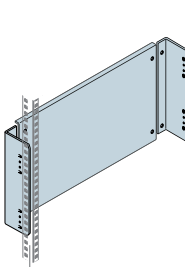

MD1600
MD1800
MD2000

Opaque apparatus holder back plates

15/10 thick opaque apparatus holder back plate. Fixed directly on uprights MD1800 or MD2000. The working dimension is always 100mm less than the total height of the enclosure.

Description	Dimensions (mm)		Type/ Order code	Pkg/ No. pcs
	H	W		
Opaque apparatus holder back plate	200	600	EH2065	1/1
Opaque apparatus holder back plate	300		EH3065	1/1
Opaque apparatus holder back plate	400		EH4065	1/1
Opaque apparatus holder back plate	200	800	EH2085	1/1
Opaque apparatus holder back plate	300		EH3085	1/1
Opaque apparatus holder back plate	400		EH4085	1/1

AMX monobloc cabinets

Ordering codes

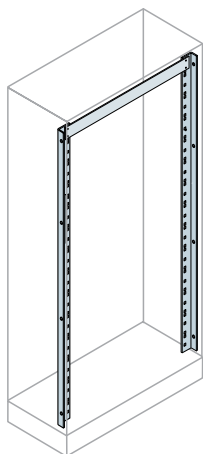

19" rack frames

The fixed uprights are made of 20/10 galvanised steel and are fixed to the front of the structure W=600mm.

Description	Dimensions (mm)		Type/ Order code	Pkg/ No. pcs
	H			
Pair of uprights fixed rack 34HE	1600		TK1600	1/2
Pair of uprights fixed rack 38HE	1800		TK1800	1/2
Pair of uprights fixed rack 42HE	2000		TK2000	1/2

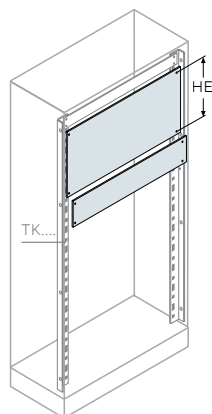

Opaque aluminium panels for 19" rack frames

Opaque compensation panels made of 30/10 thick opaque natural-coloured anodised aluminium, with 465mm centre-to-centre distance between holes.

Description	Dimensions (mm)		Type/ Order code	Pkg/ No. pcs
	H			
Panel for 19" rack frame 1HE	44,45		EG1991	1/1
Panel for 19" rack frame 2HE	89		EG1902	1/1
Panel for 19" rack frame 3HE	133		EG1903	1/1
Panel for 19" rack frame 4HE	177,5		EG1904	1/1
Panel for 19" rack frame 5HE	222		EG1905	1/1
Panel for 19" rack frame 6HE	266,5		EG1906	1/1
Panel for 19" rack frame 7HE	311		EG1907	1/1
Panel for 19" rack frame 8HE	355,5		EG1908	1/1
Panel for 19" rack frame 9HE	400		EG1909	1/1
Panel for 19" rack frame 10HE	444,5		EG1910	1/1
Panel for 19" rack frame 11HE	488		EG1911	1/1
Panel for 19" rack frame 12HE	533		EG1912	1/1
Panel for 19" rack frame 13HE	577,5		EG1913	1/1
Panel for 19" rack frame 14HE	622		EG1914	1/1
Panel for 19" rack frame 15HE	666		EG1915	1/1
Panel for 19" rack frame 16HE	711		EG1916	1/1
Panel for 19" rack frame 17HE	755,5		EG1917	1/1
Panel for 19" rack frame 18HE	800		EG1918	1/1
Panel for 19" rack frame 19HE	844,5		EG1999	1/1
Panel for 19" rack frame 20HE	889		EG1920	1/1

AMX monobloc cabinets

Ordering codes

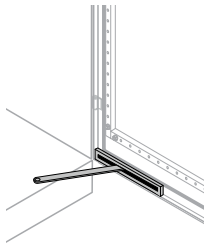

Door anti-closure device

Device which can only be fitted on versions with opaque door. Two devices are required for versions with double doors. Holds the door in the open position.

Description	Type/ Order code	Pkg/ No. pcs
Door anti-closure device	TA5510	1/1

Cannot be fitted if there is an inner door, glass door and modular panel present.

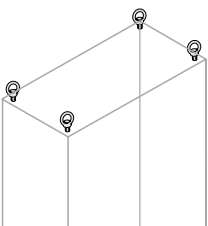

Lifting eyebolts

Allow enclosure handling using an overhead travelling crane. Fixed directly on the enclosure roof. Made of steel, with a white galvanised surface treatment.

Description	Type/ Order code	Pkg/ No. pcs
4 lifting eyebolts M12	TA9601	1/4

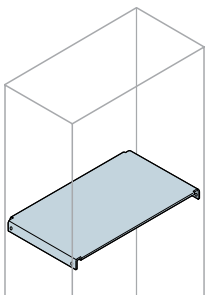

Horizontal partition panels

15/10 thick galvanised sheet steel panel for horizontally separating the various components inside the structure.

Description	Dimensions (mm)		Type/ Order code	Pkg/ No. pcs
	W	D		
Horizontal partition panel	600	400	TE6041	1/1
Horizontal partition panel		500	TE6051	1/1
Horizontal partition panel	800	400	TE8041	1/1
Horizontal partition panel		500	TE8051	1/1
Horizontal partition panel	1000	400	TE1041	1/1
Horizontal partition panel		500	TE1051	1/1

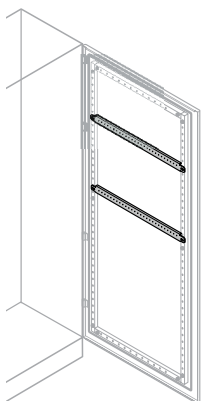

Horizontal reinforcement sections for doors

Crosspieces made of galvanised steel with drilling with 25mm pitch, for fixing accessories (e.g.: wiring ducts) inside opaque doors. Fixed to the door reinforcement tube.

Description	Dimensions (mm)		Type/ Order code	Pkg/ No. pcs
	W			
No. 2 horizontal sections h=35mm	600		EB1041	1/2
No. 2 horizontal sections h=35mm	800		EB1042	1/2
No. 2 horizontal sections h=35mm	1000		EB1043	1/2

AMX monobloc cabinets

Ordering codes

Closing systems

May substitute standard fasteners for the external doors. The inserts are interchangeable and easily substituted by loosening a single nut.

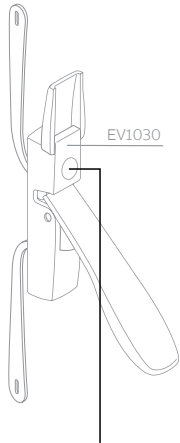

EV1030

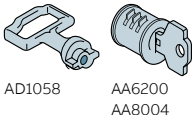

AD1058

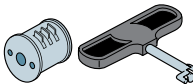
AA6200
AA8004

AA6160

AA1570

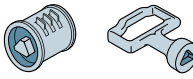

AA6120

AA1560

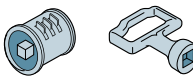

AA6140

AA6141

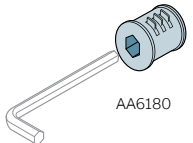

AA6180

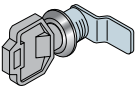
AA8001X
External door double
door version

EV1008

EV1036
EV1037

Description	Type/ Order code	Pkg/ No. pcs
Spare parts and accessories for EV1030 handle		
Handle complete with lock	EV1030	1/1
Zamak (Zn+Al+Mg) alloy key for double tongue insert, for external door, single door version	AD1058	1/1
Yale insert and key for external door, single door version	AA6200	1/1
Ronis E739 insert and key for external door, single door version	AA8004	1/1
Ronis insert 455 and key	PIRH0455	1/1
Ronis insert 2432E and key	PIRH2432	1/1
Ronis insert 1242E and key	PIRH1242	1/1
Ronis insert 405 and key	PIRH0405	1/1
FIST (FIAT) insert for external door, single door version	AA6160	1/1
FIAT key for external door, single door version	AA1570	1/1
Triangular insert, 6.4 male on Ø7.6, for external door, single door version	AA6120	1/1
Key for triangular insert for external door, single door version	AA1560	1/1
Square insert, 7 male, for external door, single door version	AA6140	1/1
Key for square insert for external door, single door version	AA6141	1/1
Hexagonal insert, 8mm socket type; key not available; for external door, single door version	AA6180	1/1
Plastic key for triangular insert AA5200 for external door, double doors version	AA6190	1/1
Box Ø19mm double tongue, chrome-finished plastic and key for external door, double doors version	AA8001X	1/1
Spare parts and accessories for EV1008 box		
Box with double tongue insert made of plastic with key for inner door	EV1008	1/1
Single code Yale insert for inner door	EV1036	1/1
Ronis 455 insert for inner door	EV1037	1/1
3mm double tongue insert for inner door	EV1039	1/1
Double tongue insert for handle/closing box	AA6100	1/1

AMX monobloc cabinets

Ordering codes

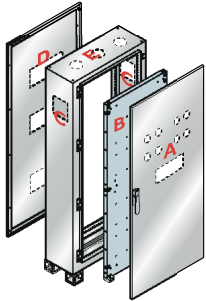

Special drilling service

The extra cost depends on the number of individual parts drilled rather than the number of holes made. By individual part we mean: **A**-door; **B**-plate; **C**-sides; **D**-back and **E**-roof. Include the layout drawing of the holes to be drilled (see page 7/28 for possible drilling areas).

Spare parts

Description	Dimensions (mm)		Type/ Order code	Pkg/ No. pcs
	H	W		
Opaque door	1600	600	TC1606X	1/1
Opaque door		800	TC1608X	1/1
Opaque door	1800	600	TC1806X	1/1
Glass door		600	TT1806X	1/1
Opaque door		800	TC1808X	1/1
Glass door		800	TT1808X	1/1
Opaque door		1000	TC1810X	1/1
Glass door		1000	TT1810X	1/1
Opaque door with handle for double doors version		600+600	TC1812DX	1/1
Opaque door with overlapping closing for double doors version		600+600	TC1812SX	1/1
Opaque door	2000	600	TC2006X	1/1
Glass door		600	TT2006X	1/1
Opaque door		800	TC2008X	1/1
Glass door		800	TT2008X	1/1
Opaque door		1000	TC2010X	1/1
Glass door		1000	TT2010X	1/1
Opaque door with handle for double doors version		600+600	TC2012DX	1/1
Opaque door with overlapping closing for double doors version		600+600	TC2012SX	1/1
Rear panel	1600	600	TE1660X	1/1
Rear panel		800	TE1680X	1/1
Rear panel	1800	600	TE1860X	1/1
Rear panel		800	TE1880X	1/1
Rear panel		1000	TE1810X	1/1
Rear panel		1200	TE1812X	1/1
Rear panel	2000	600	TE2060X	1/1
Rear panel		800	TE2080X	1/1
Rear panel		1000	TE2010X	1/1
Rear panel		1200	TE2012X	1/1



Chapter 4

ISX modular cabinets

4-2 General characteristics and applications

4-4 Selection of the structure

4-6 Ordering codes

ISX modular cabinets

General characteristics and applications

ABB is updating its supply of cabinets for automation with the new series of AISI 304 stainless steel ISX modular cabinets, suitable for creating electrical enclosures for automation, command and control.

ISX modular cabinets also conform to IEC EN 62208 and IEC 61439-1-2. The ISX range passed cabinet vibrations tests according to IEC 60068-2-57 and seismic tests according to IEE Std 693.

ISX modular cabinets have a degree of protection IP65 (IEC EN 60529) and NEMA Type 1, 12 (UL standard).

The degree of protection against external mechanical impacts is IK10 for the version with opaque door and IK09 for the version with glass door (IEC 62262). The AISI 304 stainless steel allows the cabinets to be fitted both indoors and outdoors, by fixing them to the floor.

Available with opaque door or glass door, they have a structure with removable roof, complete with opaque door and rear panel, fixed cable entry flanges, plinth H=100 mm made up of four angular parts and can be completed with plinth flanges and side panels.

Available in two heights, H=1800 mm and H=2000 mm, with a double doors version (only opaque) with width W=1200 mm.

For ISX modular cabinets the following are available: horizontal reinforcement sections for door, folding shelves for door, door anticlosure device, standard back plate and relative recessing/joining/ reinforcement kits, oversized back plate and relative joining/ reinforcement kits, tracks for plate lateral insertion, opposite mounting plate, partial back plate, crosspieces H=48/100 mm, crosspieces for base, transformer holder crosspieces, connector holder panel, vertical/horizontal partition panels, horizontal/vertical busbar segregations, DIN uprights, apparatus holder back plate, standard back plate for bench cabling, lifting eyebolts/brackets, lamps, voltage detector devices, position switch.



ISX modular enclosures allow the set-up of batteries of cabinets side by side for controlling complex industrial plants in environments requiring high standards of hygiene, for example the food, chemical and pharmaceutical sectors. They are suitable for installation on the floor with lateral and rear access, plus mounting plate position adjustment.

—
01 Structure
 AISI 304 stainless steel modular structure with 3-way joint made in aluminium.

—
01

—
02 Plinths
 plinths with removable flanges made of AISI 304 stainless steel, with a hole for fixing to the floor.

—
02

Technical characteristics

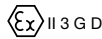
Conforms to	CEI EN 62208, IEC 61439-1-2
Degree of protection	IP65 (CEI EN 60529) NEMA type 1,12 (UL standard)
Degree of mechanical protection	IK10 opaque door IK09 glass door (IEC 62262)
Certifications	 
Type of material	AISI 304
Installation site	indoors/outdoors
Fixing method	floor/wall
Normal operating conditions - ambient temperature	from -25 to +40°C

ISX modular cabinets

Selection of the structure

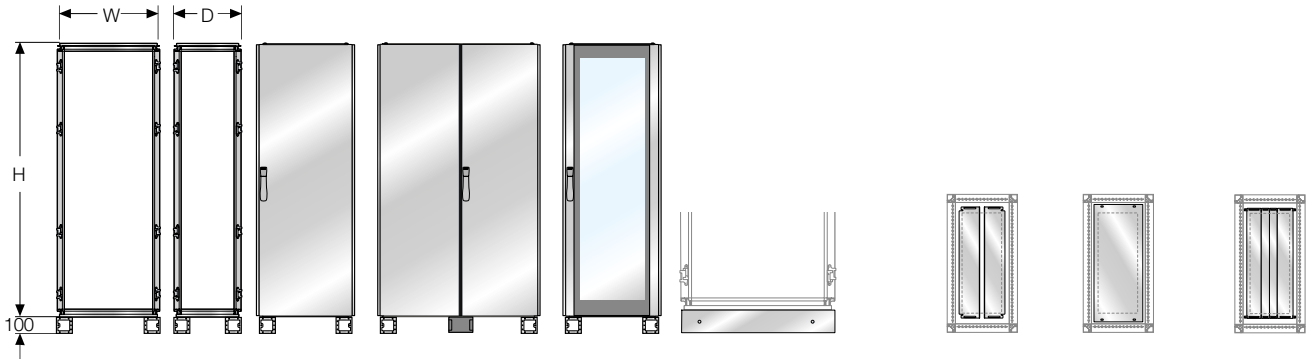

External overall dimensions			Cabinet with opaque door			Pair of plinth flanges		Cable entry flanges		
H mm	W mm	D mm	Opaque door	Double opaque doors overlap closing	Glass door	Front / back	side	Sliding	Fixed	Built-up
1800	600	400	ES1864X		ES1864VX	ZN6000X	ZN4001X	EF6040X	EF6043X	EF6041X
	800		ES1884X		ES1884VX	ZN8000X	ZN4001X	EF8040X	EF8042X	EF8041X
	600	500	ES1865X		ES1865VX	ZN6000X	ZN5001X	EF6050X	EF6052X	EF6051X
	800		ES1885X		ES1885VX	ZN8000X	ZN5001X	EF8050X	EF8052X	EF8051X
	1000		ES1805X		ES1805VX	ZN1000X	ZN5000X	EF1053X	EF1052X	EF1051X
	1000		ES1806X		ES1806VX	ZN1000X	ZN6000X	EF1060X	EF1062X	EF1061X
	1200	500		ES1827BX		2xZN6000X	ZN5001X	2xEF6050X	2xEF6052X	2xEF6051X
	1200	600		ES1826BX		2xZN6000X	ZN6000X	2xEF6060X	2xEF6062X	2xEF6061X
2000	600	500	ES2065X		ES2065VX	ZN6000X	ZN5001X	EF6050X	EF6052X	EF6051X
	800		ES2085X		ES2085VX	ZN8000X	ZN5001X	EF8050X	EF8052X	EF8051X
	1000		ES2007X		ES2005VX	ZN1000X	ZN5001X	EF1053X	EF1052X	EF1051X
	600	600	ES2066X		ES2066VX	ZN6000X	ZN6000X	EF6060X	EF6062X	EF6061X
	800		ES2086X		ES2086VX	ZN8000X	ZN6000X	EF8060X	EF8062X	EF8061X
	1000		ES2006X		ES2006VX	ZN1000X	ZN6000X	EF1060X	EF1062X	EF1061X
	1200		500		ES2025BX		2xZN6000X	ZN5001X	2xEF6050X	2xEF6052X
	1200	600		ES2026BX		2xZN6000X	ZN6000X	2xEF6060X	2xEF6062X	2xEF6061X

(*) The working height is always 100mm less than the external dimension of the enclosure.

For the version with compartments the working height is 200mm less.

⁽¹⁾ Crosshead screws for Phillips 3 insert.

⁽²⁾ Standard plates joining kit: EA1800 (H=1800mm); EA2000 (H=2000mm).

⁽³⁾ EA2113 oversized plates joining kit H=1800/2000mm.

Kit for placing structures side by side EV0002/EV0003.

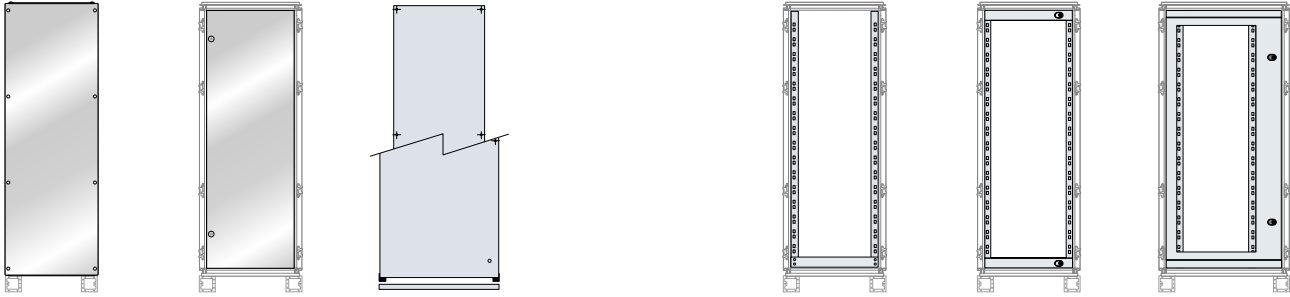

Side covers ⁽¹⁾	Inner door	Back plates		Rack frame		
		Standard ⁽²⁾	Oversize + tracks ⁽³⁾	Fixed Centred	Swing Centred W=600mm	Eccentric W=800mm
Pair of opaque panels						
EL1840X	EE1860X	EA1860	EA1960	EG1800	EG1801K	
EL1840X	EE1880X	EA1880	EA1981	EG1880		EG1803K
EL1850X	EE1860X	EA1860	EA1960	EG1800	EG1801K	
EL1850X	EE1880X	EA1880	EA1981	EG1880		EG1803K
EL1850X	EE1810X	EA1810	EA1910			
EL1860X	EE1810X	EA1810	EA1910			
EL1850X		EA1812	EA1912			
EL1860X		EA1812	EA1912			
EL2050X	EE2060X	EA2060	EA2161	EG2000	EG2001K	
EL2050X	EE2080X	EA2080	EA2180	EG2080		EG2003K
EL2050X	EE2010X	EA2010	EA2110			
EL2060X	EE2060X	EA2060	EA2161	EG2000	EG2001K	
EL2060X	EE2080X	EA2080	EA2180	EG2080		EG2003K
EL2060X	EE2010X	EA2010	EA2110			
EL2050X		EA2013	EA2112			
EL2060X		EA2013	EA2112			

ISX modular cabinets

Ordering codes

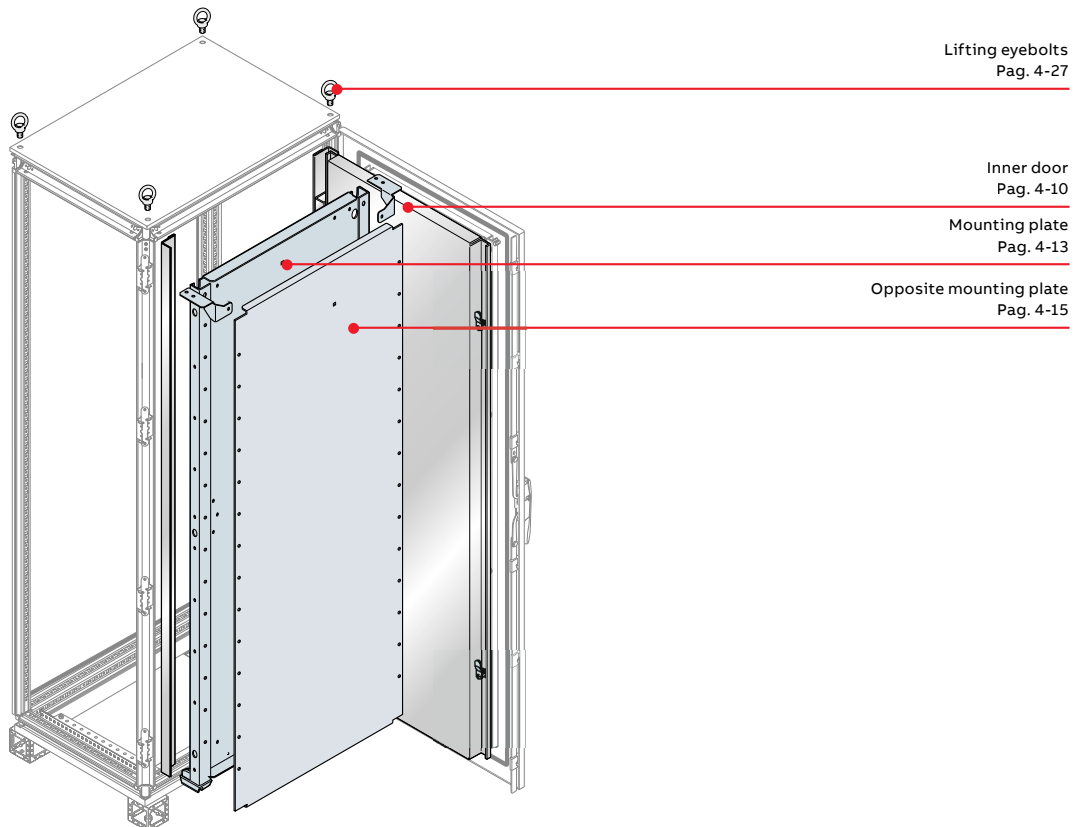
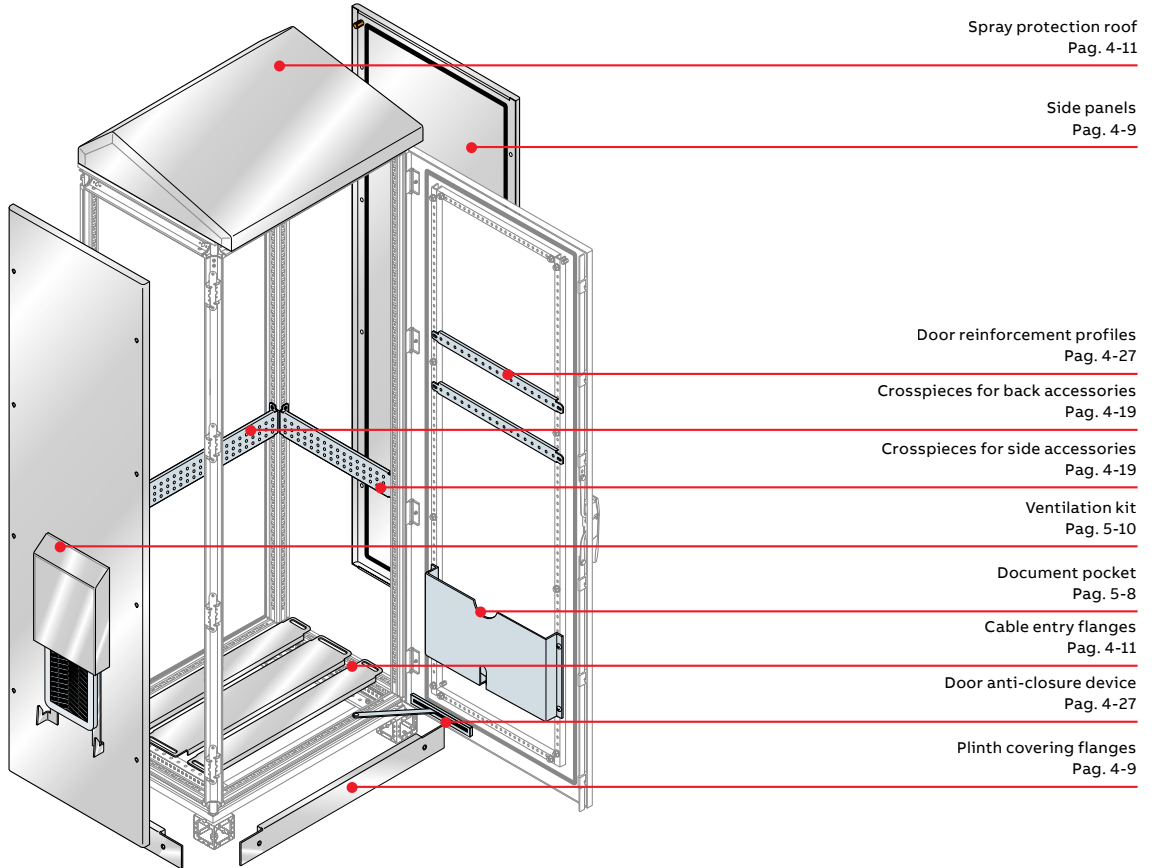

ISX modular cabinets
Ordering codes

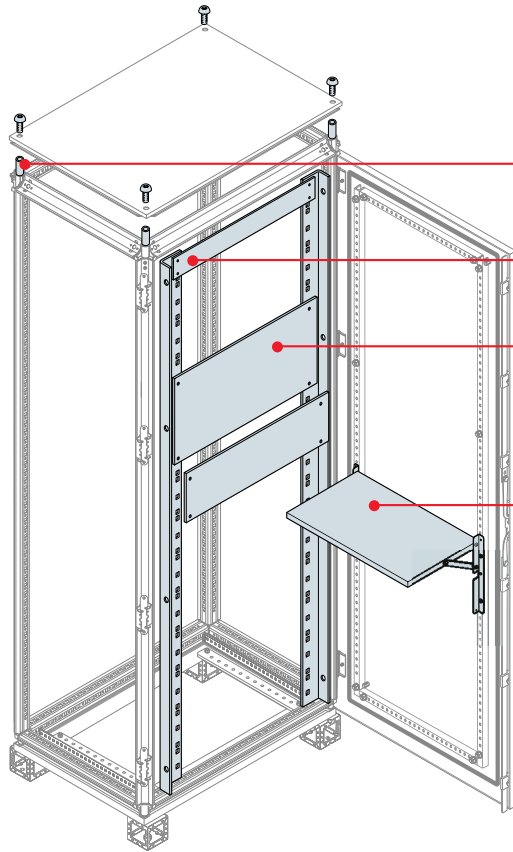

Natural ventilation
Pag. 4-18

19" rack frames
Pag. 4-24

Panels for 19" rack frames
Pag. 4-25

Folding shelf for door
Pag. 4-27

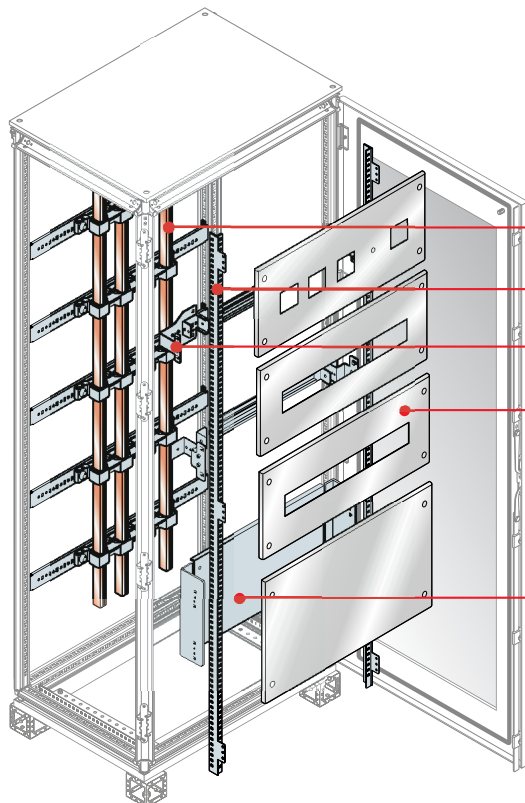

Distribution system
Pag. 4-28

Uprights for DIN rail
Pag. 4-20

DIN rail kit
Pag. 4-20

Panels for modular equipment
Pag. 4-21

Opaque apparatus holder back plates
Pag. 4-22

ISX modular cabinets

Ordering codes



Cabinets with opaque door

Structure with removable roof complete with opaque door and rear panel(*), fixed cable entry flanges, plinth H=100mm consisting of four angular parts. To be completed with plinth flanges and side panels.

Dimensions (mm)			Type/ Order code	Pkg/ No. pcs
H	W	D		
Opaque inner door				
1800	600	400	ES1864X	1/1
	800		ES1884X	1/1
	600	500	ES1865X	1/1
	800		ES1885X	1/1
	1000		ES1805X	1/1
	1000	600	ES1806X	1/1
	1200 ⁽¹⁾	500	ES1827BX	1/1
	1200 ⁽¹⁾	600	ES1826BX	1/1
2000	600	500	ES2065X	1/1
	800		ES2085X	1/1
	1000		ES2007X	1/1
	600	600	ES2066X	1/1
	800		ES2086X	1/1
	1000		ES2006X	1/1
	1200 ⁽¹⁾	500	ES2025BX	1/1
	1200 ⁽¹⁾	600	ES2026BX	1/1

(*) Crosshead screws for Phillips 3 insert.

⁽¹⁾ Version with double doors.



Cabinets with glass door

Structure with removable roof complete with glass door and rear panel(*), fixed cable entry flanges, plinth H=100mm consisting of four angular parts. To be completed with plinth flanges and side panels⁽¹⁾.

Dimensions (mm)			Type/ Order code	Pkg/ No. pcs
H	W	D		
Opaque inner door				
1800	600	400	ES1864VX	1/1
	800		ES1884VX	1/1
	600	500	ES1865VX	1/1
	800		ES1885VX	1/1
	1000		ES1805VX	1/1
	1000	600	ES1806VX	1/1
2000	600	500	ES2065VX	1/1
	800		ES2085VX	1/1
	1000		ES2005VX	1/1
	600	600	ES2066VX	1/1
	800		ES2086VX	1/1
	1000		ES2006VX	1/1

(*) Crosshead screws for Phillips 3 insert.

ISX modular cabinets

Ordering codes

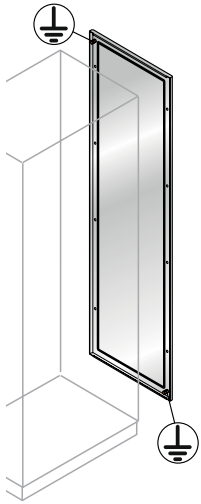

Blind side panels

15/10 thick stainless steel side panel^(*), with polyurethane gasket, complete with earthing pins.

Description	Dimensions (mm)		Type/ Order code	Pkg/ No. pcs
	H	W		
Pair of opaque panels	1800	400	EL1840X	1/2
Pair of opaque panels		500	EL1850X	1/2
Pair of opaque panels		600	EL1860X	1/2
Pair of opaque panels	2000	500	EL2050X	1/2
Pair of opaque panels		600	EL2060X	1/2

^(*) Crosshead screws for Phillips 3 insert.

pair of covering flanges front/rear

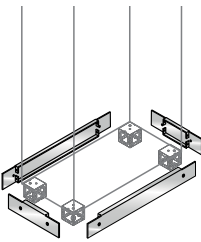

Plinth covering flanges

AISI 304 stainless steel monobloc removable flanges (not load-bearing).

Description	Dimensions (mm)		Type/ Order code	Pkg/ No. pcs
	H	W		
Pair of covering flanges front/rear	100	600	ZN6000X	1/2
Pair of covering flanges front/rear		800	ZN8000X	1/2
Pair of covering flanges front/rear		1000	ZN1000X	1/2
Pair of side flanges	100	400	ZN4001X	1/2
Pair of side flanges		500	ZN5001X	1/2
Pair of side flanges		600	ZN6000X	1/2

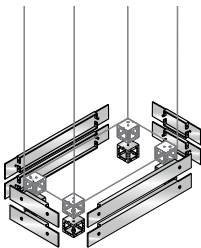

Additional plinth

To obtain a plinth 200mm high, order an angular parts kit H=100mm to be completed with 2 covering flanges (H=100mm) for each side of the structure.

Description	Dimensions (mm)		Type/ Order code	Pkg/ No. pcs
	H			
4 angular parts	100		ZN1010X	1/4

ISX modular cabinets

Ordering codes

One-piece roof

AISI 304 stainless steel roof made in a single piece, completes the joining of enclosures positioned side by side.

Description	Type/ Order code	Pkg/ No. pcs
One-piece roof for side by side ISX	TU1000X	1/4

Inner doors

15/10 thick AISI 304 stainless steel internal door, complete with reinforcement tube, frame, hinges and 2 boxes with double tongue key. Maximum opening 100°.

Description	Dimensions (mm)		Type/ Order code	Pkg/ No. pcs
	H	W		
Internal doors	100	600	EE1860X	1/1
Internal doors		800	EE1880X	1/1
Internal doors		1000	EE1810X	1/1
Internal doors	100	400	EE2060X	1/1
Internal doors		500	EE2080X	1/1
Internal doors		600	EE2010X	1/1

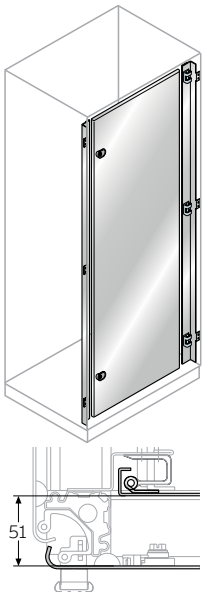

Recessed inner doors

15/10 thick stainless sheet steel internal door, complete with frame, hinges and 2 boxes. Maximum opening 100°.

Dimensions (mm)		Type/ Order code	Pkg/ No. pcs
H	W		
Recessed inner door			
1800	600	EE1906X	1/1
	800	EE1908X	1/1
	1000	EE1910X	1/1
2000	600	EE2106X	1/1
	800	EE2108X	1/1
	1000	EE2110X	1/1

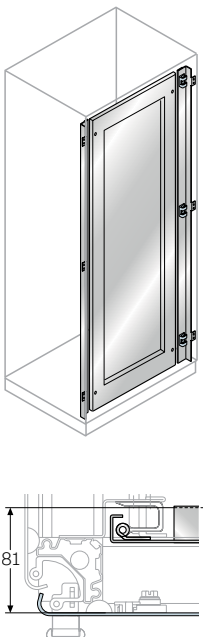

ISX modular cabinets

Ordering codes

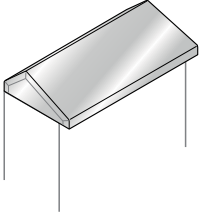

Spray protection roofs

Made of 15/10 stainless sheet steel.

Description	Dimensions (mm)		Type/ Order code	Pkg/ No. pcs
	W	D		
Spray protection roof	600	400	TP6040X	1/1
Spray protection roof	600	500	TP6050X	1/1
Spray protection roof	800	400	TP8040X	1/1
Spray protection roof	800	500	TP8050X	1/1
Spray protection roof	800	600	TP8060X	1/1
Spray protection roof	1000	500	TP1050X	1/1
Spray protection roof	1000	600	TP1060X	1/1
Spray protection roof	1200	500	TP1250X	1/1
Spray protection roof	1200	600	TP1260X	1/1

Cable entry flanges

20/10 stainless sheet steel flanges. Sliding, built-up and fixed type.

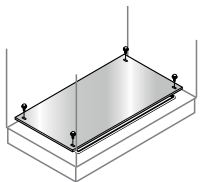
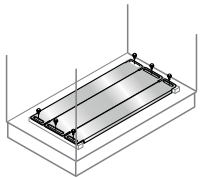
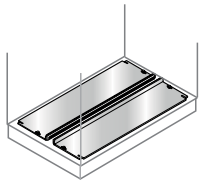

Description	Dimensions (mm)		Type/ Order code	Pkg/ No. pcs
	W	D		
Sliding cable entry flanges	600		EF6040X	1/1
Sliding cable entry flanges	800		EF8040X	1/1
Sliding cable entry flanges	600		EF6050X	1/1
Sliding cable entry flanges	800		EF8050X	1/1
Sliding cable entry flanges	1000		EF1053X	1/1
Sliding cable entry flanges	600		EF6060X	1/1
Sliding cable entry flanges	800		EF8060X	1/1
Sliding cable entry flanges	1000		EF1060X	1/1
Built-up cable entry flanges	600		EF6041X	1/1
Built-up cable entry flanges	800		EF8041X	1/1
Built-up cable entry flanges	600		EF6051X	1/1
Built-up cable entry flanges	800		EF8051X	1/1
Built-up cable entry flanges	1000		EF1051X	1/1
Built-up cable entry flanges	600		EF6061X	1/1
Built-up cable entry flanges	800		EF8061X	1/1
Built-up cable entry flanges	1000		EF1061X	1/1
Fixed cable entry flanges	600		EF6043X	1/1
Fixed cable entry flanges	800		EF8042X	1/1
Fixed cable entry flanges	600		EF6052X	1/1
Fixed cable entry flanges	800		EF8052X	1/1
Fixed cable entry flanges	1000		EF1052X	1/1
Fixed cable entry flanges	600		EF6062X	1/1
Fixed cable entry flanges	800		EF8062X	1/1
Fixed cable entry flanges	1000		EF1062X	1/1

For structures with W=1200mm order 2 x parts with W=600mm.

ISX modular cabinets

Ordering codes

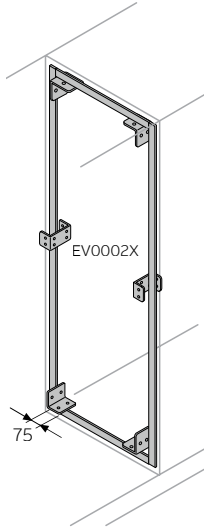

Kit for placing structures side by side

High density adhesive polyurethane gasket - guarantees the degree of protection on several columns positioned side by side. The kits come complete with 8 stainless steel AISI 304 small pins.

Description	Type/ Order code	Pkg/ No. pcs
Kit for joining angular reinforcement part for lifting	EV0002X	1/1
Cabinet joining kit	EV0003X	1/1
Internal cabinet joining kit	EV0006X	1/1

EV0002X

This kit consists of 6 brackets (4 "L"-shaped and 2 "C"-shaped), an adhesive gasket and 8 small pins. Joining is from the inside using the 4 "L"-shaped brackets which can be fitted in the corners and the two 2 "C"-shaped brackets which can be mounted at any height on the enclosure. Does not allow maximum recessing of the standard and oversized back plate (75mm less).

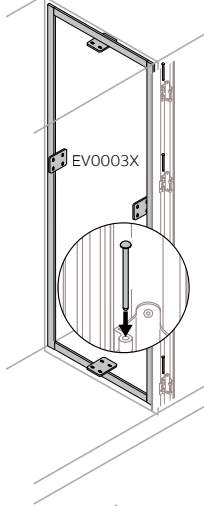

EV0003X internal external enclosure joining kit

This kit consists of 4 brackets, an adhesive gasket and 8 small pins. Joining is:

- from the inside using the 4 brackets which can be fitted anywhere along the height or depth of the enclosure
- from the outside using the 8 small pins inserted in the hinges (this requires removal of the rear panel).

EV0006X internal enclosure joining kit

This kit consists of 6 brackets, an adhesive gasket and 8 small pins. Joining is from the inside using the 6 brackets which can be fitted anywhere along the height or depth of the enclosure.

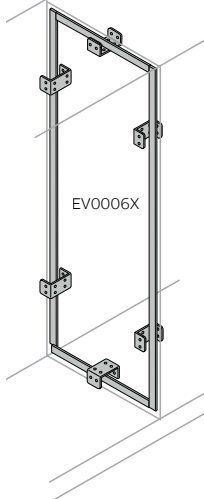

EV0002X	OK			OK	OK	OK		OK	OK	OK
EV0003X	OK	OK	OK	OK	OK	OK	OK	OK	OK	OK
EV0006X	OK	OK	OK			OK				

ISX modular cabinets

Ordering codes

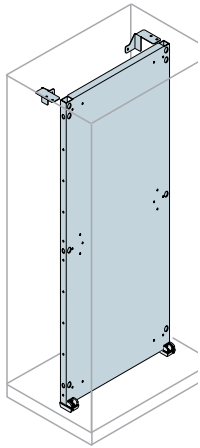

Standard back plate

25/10 galvanised steel plate which can be inserted from the front (standard) or the side with tracks (to be ordered separately). Complete with supports for sliding and fixing. Possibility of placing side by side or recessing using the special kits.

Description	Dimensions (mm)		Type/ Order code	Pkg/ No. pcs
	H	W		
Mounting plate	1800	600	EA1860	1/1
Mounting plate		800	EA1880	1/1
Mounting plate		1000	EA1810	1/1
Mounting plate		1200	EA1812	1/1
Mounting plate	2000	600	EA2060	1/1
Mounting plate		800	EA2080	1/1
Mounting plate		1000	EA2010	1/1
Mounting plate		1200	EA2013	1/1

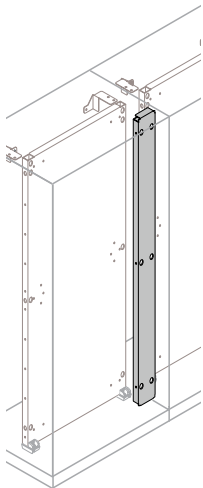

Standard back plate joining kit

Description	Dimensions (mm)		Type/ Order code	Pkg/ No. pcs
	H	W		
Plate joining kit	1800		EA1800	1/1
Plate joining kit	2000		EA2000	1/1

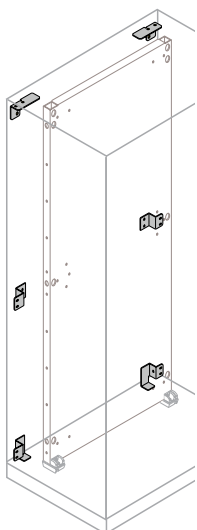

Kit for recessing standard mounting plates

Description	Type/ Order code	Pkg/ No. pcs
Kit for recessing plate	EA2100	1/1

ISX modular cabinets

Ordering codes

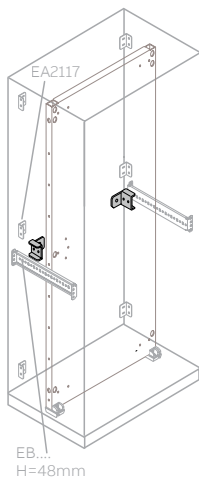

Kit for fixing standard mounting plate in the middle

Allows further fixing of the mounting plate even in the middle, in addition to the side crosspieces
H=48mm (see page 4/19).

Description	Type/ Order code	Pkg/ No. pcs
Mounting plate fixing kit	EA2115	1/2

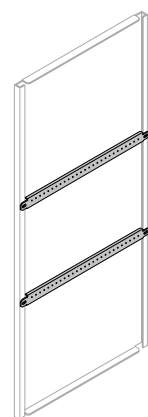

Reinforcement profiles for mounting plate

20/10 thick galvanised sections, for reinforcing standard back plates. Recommended for particularly heavy components fixed on the mounting plate.

Description	Dimensions (mm)		Type/ Order code	Pkg/ No. pcs
	W			
N° 2 plate horizontal reinforcement sections	600		EA6003	1/2
N° 2 plate horizontal reinforcement sections	800		EA8003	1/2
N° 2 plate horizontal reinforcement sections	1000		EA1003	1/2
N° 2 plate horizontal reinforcement sections	1200		EA1203	1/2
N° 6 plate fixing intermediate reinforcements			EA2117	1/6

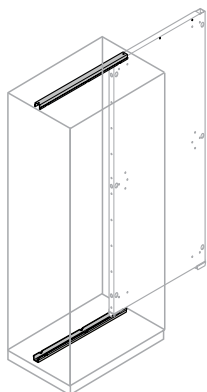

Tracks for plate lateral insertion

Allow standard and oversized mounting plates to be inserted from the side. Made up of two sections (one upper and one lower).

Description	Dimensions (mm)		Type/ Order code	Pkg/ No. pcs
	W			
Tracks for plate lateral insertion	600		EA0600	1/2
Tracks for plate lateral insertion	800		EA0802	1/2
Tracks for plate lateral insertion	1000		EA1000	1/2
Tracks for plate lateral insertion	1200		EA1200	1/2

ISX modular cabinets

Ordering codes

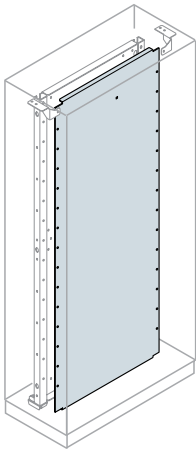

Opposite mounting plate

Mounting plate with extremely small depth dimension, so that components can be mounted on both sides (front and rear). Made of 25/10 galvanised steel. Can be inserted from the front and/or rear. Complete with supports for sliding and fixing.

Description	Dimensions (mm)		Type/ Order code	Pkg/ No. pcs
	H	W		
Opposite mounting plate	1800	600	EA5861	1/1
Opposite mounting plate		800	EA5883	1/1
Opposite mounting plate		1000	EA5811	1/1
Opposite mounting plate		1200	EA5822	1/1
Opposite mounting plate	2000	600	EA5063	1/1
Opposite mounting plate		800	EA5083	1/1
Opposite mounting plate		1000	EA5011	1/1
Opposite mounting plate		1200	EA5022	1/1

For the mounting of the opposite mounting plate it is necessary to order also the standard mounting plate.

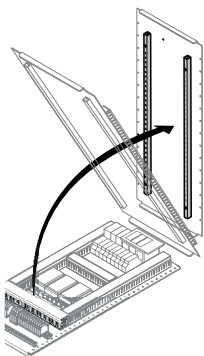

Opposite mounting plate reinforcement sections

The reinforcement sections allow both vertical and horizontal opposite mounting plate cabling. The sections are fixed to the plate using special pressure pins, without drilling the plate.

Description	Dimensions (mm)		Type/ Order code	Pkg/ No. pcs
	H	W		
N° 2 reinforcements for opposite plate	1800		EA0018	1/2
N° 2 reinforcements for opposite plate	2000		EA0020	1/2

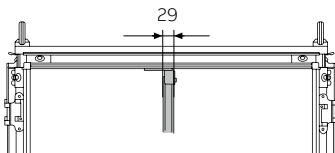

Back to back kit

For coupling 2 standard plates to produce the minimum footprint.

Description	Type/ Order code	Pkg/ No. pcs
Back to back standard plates kit	EA2118	1/1

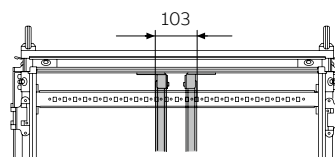
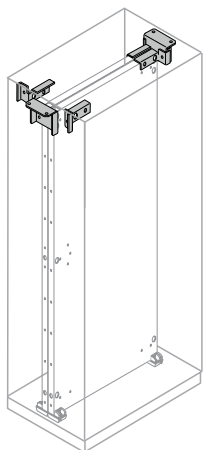

Traditional side by side: standard plate + standard plate

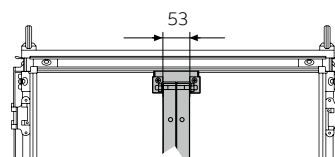

Side by side with EA2118: standard mounting plate + standard mounting plate + kit EA2118

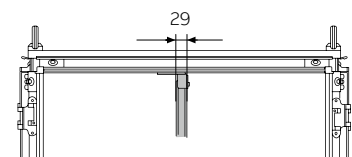

Standard mounting plate + opposite mounting plate.

ISX modular cabinets

Ordering codes

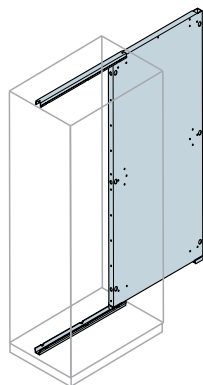

Oversized back plates

25/10 galvanised steel plate, can only be inserted by sliding from the side, using balls with tracks included in the kit. Possibility of placing side by side using the special kit.

Including tracks for lateral insertion

Description	Dimensions (mm)		Type/ Order code	Pkg/ No. pcs
	H	W		
Oversized back plate+tracks	1800	600	EA1960	1/1
Oversized back plate+tracks		800	EA1981	1/1
Oversized back plate+tracks		1000	EA1910	1/1
Oversized back plate+tracks		1200	EA1912	1/1
Oversized back plate+tracks	2000	600	EA2161	1/1
Oversized back plate+tracks		800	EA2180	1/1
Oversized back plate+tracks		1000	EA2110	1/1
Oversized back plate+tracks		1200	EA2112	1/1

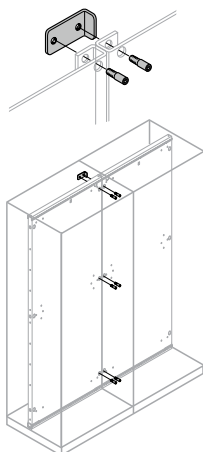

Oversized back plates joining kit

Description	Type/ Order code	Pkg/ No. pcs
Oversized plates joining kit	EA2113	1/1

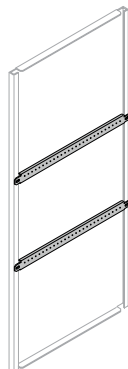

Oversized mounting plates reinforcement sections

20/10 thick galvanised sections, for reinforcing standard back plates. Recommended for particularly heavy components fixed on the mounting plate.

Description	Dimensions (mm)		Type/ Order code	Pkg/ No. pcs
	W	H		
2 plate horizontal reinforcement sections	600		EA6002	1/2
2 plate horizontal reinforcement sections	800		EA8002	1/2
2 plate horizontal reinforcement sections	1000		EA1002	1/2
2 plate horizontal reinforcement sections	1200		EA1202	1/2

ISX modular cabinets

Ordering codes

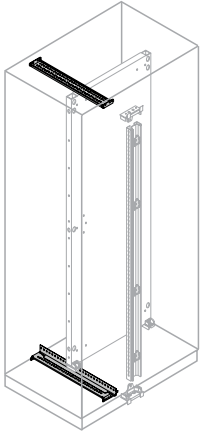

Sliding rails for insertion of mounting plate with partial width

These allow insertion of the standard mounting plate from the front in structures with a cable container or if the double door structure is partly used. A special sliding track is inserted in the lower crosspiece.

Description	Dimensions (mm)		Type/ Order code	Pkg/ No. pcs
	D			
No. 1 sliding rail and No. 1 crosspiece for back plate	400		EB4101	1/2
No. 1 sliding rail and No. 1 crosspiece for back plate	500		EB5101	1/2
No. 1 sliding rail and No. 1 crosspiece for back plate	600		EB6101	1/2

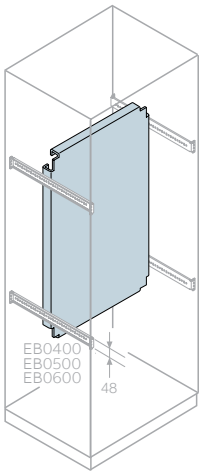

Partial back plates

25/10 thick galvanised back plates. Fixed on the crosspieces H=48mm.

Description	Dimensions (mm)		Type/ Order code	Pkg/ No. pcs
	H	W		
Partial height mounting plate	200	600	EA2062	1/1
Partial height mounting plate	300		EA3061	1/1
Partial height mounting plate	400		EA4061	1/1
Partial height mounting plate	500		EA5061	1/1
Partial height mounting plate	600		EA6061	1/1
Partial height mounting plate	800		EA8061	1/1
Partial height mounting plate	1000		EA1061	1/1
Partial height mounting plate	200	800	EA2081	1/1
Partial height mounting plate	300		EA3081	1/1
Partial height mounting plate	400		EA4081	1/1
Partial height mounting plate	500		EA5081	1/1
Partial height mounting plate	600		EA6081	1/1
Partial height mounting plate	800		EA8081	1/1
Partial height mounting plate	1000		EA1081	1/1
Partial back plate recessing kit			EA2101	1/1

ISX modular cabinets

Ordering codes

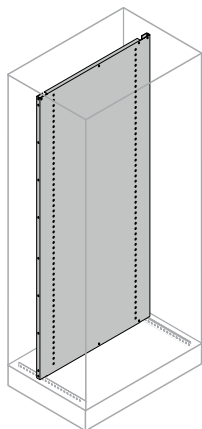

Standard back plate for bench cabling

Back plate drilled with 25mm pitch for directly fixing DIN rails GD1520, GD1530. Insertion is from the front of the enclosure and the depth is adjustable in 25mm steps.

The centre-to-centre distanced between the DIN rails may be 150 or 200mm. This solution comes complete with front panels for 24 and 36 modules respectively for W=600mm and 800mm.

Description	Dimensions (mm)		Type/ Order code	Pkg/ No. pcs
	H	W		
Back plate for bench cabling	1800	600	EX1860	1/1
Back plate for bench cabling		800	EX1880	1/1
Back plate for bench cabling	2000	600	EX2060	1/1
Back plate for bench cabling		800	EX2080	1/1

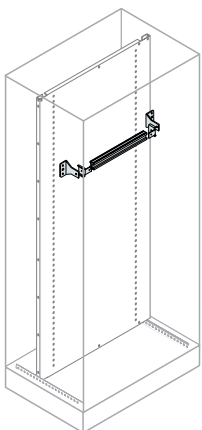

DIN rail kit on mounting plate (bench cabling)

Kit consisting of double aluminium section (DIN 35), complete with brackets. Fixed directly on the mounting plate. The working dimension is always 100mm less than the total height of the enclosure.

Description	Dimensions (mm)		Type/ Order code	Pkg/ No. pcs
	W	H		
DIN rail and fixing supports (24 DIN mod.)	600		GD1520	1/2
DIN rail and fixing supports (36 DIN mod.)	800		GD1530	1/2

For all components which cannot be mounted on DIN rails, e.g.: T3, T4, OT, OETL, mounting is directly on the plate.

ISX modular cabinets

Ordering codes

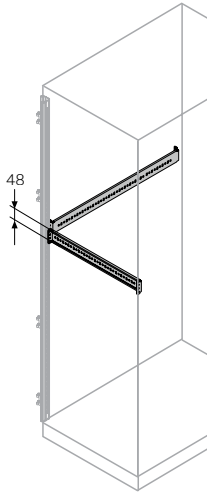

Crosspieces H=48mm for fixing front/size accessories

20/10 thick galvanised sheet metal multi-purpose crosspieces. These are fixed between the uprights and allow various accessories to be fitted as well as partial back plates and busbar holders for flat and shaped section busbars (to be drilled).

Description	Dimensions (mm)		Pkg/No. pcs
	L/D	Type/Order code	
No. 2 crosspieces for fixing accessories and partial back plates	400	EB0400	1/2
No. 2 crosspieces for fixing accessories and partial back plates	500	EB0500	1/2
No. 2 crosspieces for fixing accessories and partial back plates	600	EB0600	1/2
No. 2 crosspieces for fixing accessories and partial back plates	800	EB0800	1/2
No. 2 crosspieces for fixing accessories and partial back plates	1000	EB1000	1/2
No. 2 crosspieces for fixing accessories and partial back plates	1200	EB1200	1/2

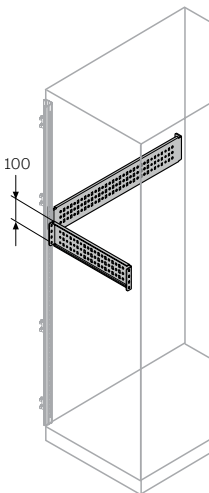

Crosspieces H=100mm for fixing front/size accessories

Multi-purpose crosspieces made of 20/10 thick galvanised sheet metal.

Description	Dimensions (mm)		Pkg/No. pcs
	L/D	Type/Order code	
No. 2 crosspieces for fixing accessories	400	EB0400	1/2
No. 2 crosspieces for fixing accessories	500	EB0500	1/2
No. 2 crosspieces for fixing accessories	600	EB0600	1/2
No. 2 crosspieces for fixing accessories	800	EB0800	1/2
No. 2 crosspieces for fixing accessories	1000	EB1000	1/2
No. 2 crosspieces for fixing accessories	1200	EB1200	1/2

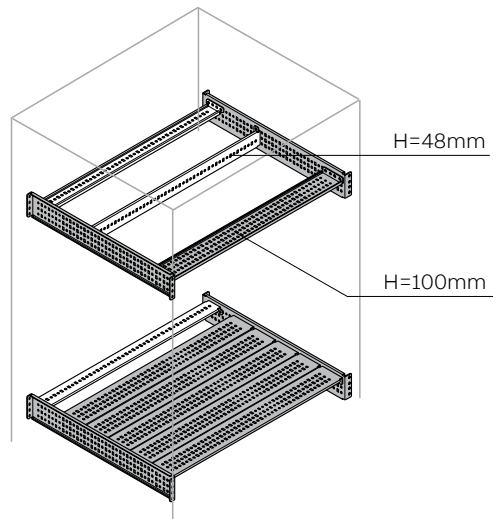
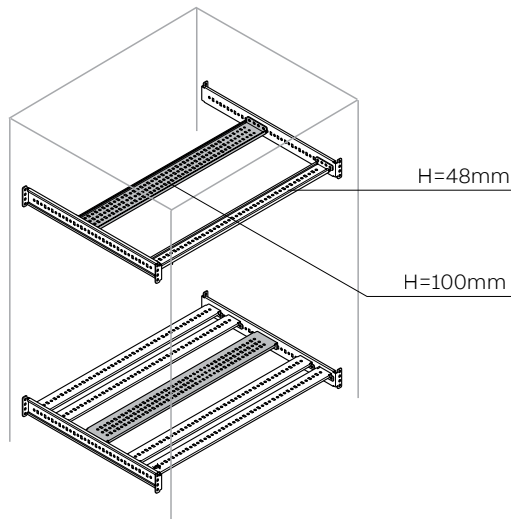

ISX modular cabinets

Ordering codes

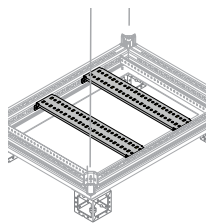

Intermediate crosspieces for fixing heavy accessories (fitted deep)

Description	Dimensions (mm)		Pkg/ No. pcs
	D	Type/ Order code	
No. 2 crosspieces for base	400	EB4100	1/2
No. 2 crosspieces for base	500	EB5100	1/2
No. 2 crosspieces for base	600	EB6100	1/2

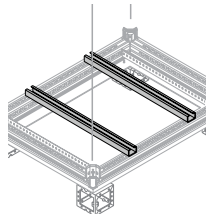

Transformer holder crosspieces

Transformer holder crosspieces made of white galvanised 35/10 thick steel sections, complete with 4 x M12 stud bolts, W=50mm.

Description	Dimensions (mm)		Pkg/ No. pcs
	D	Type/ Order code	
No. 2 transformer holder crosspieces	600	EB6102	

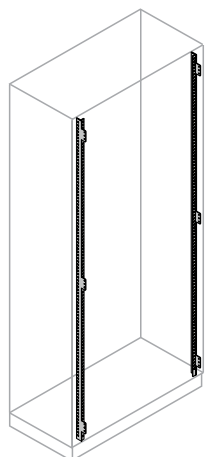

DIN rail uprights

Galvanised steel uprights drilled with a 50mm pitch. For mounting opaque apparatus holder plates, DIN rails and front panels. These must be fixed on the structure's front uprights. The working dimension is always 100mm less than the total height of the enclosure.

Description	Dimensions (mm)		Pkg/ No. pcs
	H	Type/ Order code	
No. 2 montanti per guida DIN	1800	EH1800	1/2
No. 2 montanti per guida DIN	2000	EH2000	1/2

EH0018
EH0029

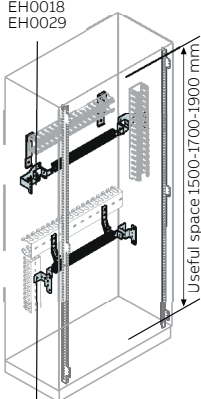

DIN rail kit and supports for fixing duct

Kit consisting of a double aluminium section (DIN 35), complete with shaped brackets for fixing wiring ducts. Fixed directly on the uprights MD1800 or MD2000. The working dimension is always 100mm less than the total height of the enclosure.

Description	Dimensions (mm)		Pkg/ No. pcs
	W	Type/ Order code	
DIN rail kit complete with supports for fixing front duct (maximum 60x80mm)			
18 DIN modules	600	EH0018	1/1
29 DIN modules	800	EH0029	1/1
DIN rail kit complete with supports for fixing rear duct (side ≥40mm)			
24 DIN modules	600	EH0024	1/1
36 DIN modules	800	EH0036	1/1

EH0024
EH0036

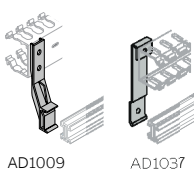

AD1009

AD1037

Supports for horizontal duct

No. 4 plastic supports	AD1009	1/4
No. 4 plastic supports	AD1037	1/4

Depth adapter

For XT1 and XT3 W=600mm	AP6000	1/4
-------------------------	--------	-----



AP6000

ISX modular cabinets

Ordering codes

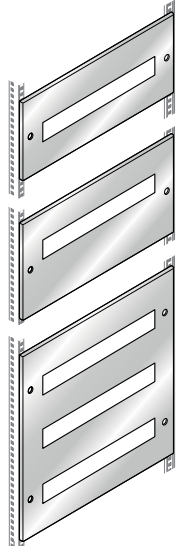

MD1600
MD1800
MD2000

Panels for modular apparatuses

12/10 stainless steel panel with modular cut-out. The working dimension of the enclosure is always 100mm less than the total height of the enclosure.

Description	Dimensions (mm)		Type/ Order code	Pkg/ No. pcs
	H	W		
Panel, 18 DIN mod.	150	600	EH1518X	1/1
	200		EH2018X	1/1
Panel, 18 DIN mod. eccentric	300		EH3018X	1/1
Panel, 54 DIN mod. (3 rows x 18 mod.)	600		EH6018X	1/1
Panel, 29 DIN mod.	150	800	EH1529X	1/1
	200		EH2029X	1/1
Panel, 29 DIN mod. eccentric	300		EH3029X	1/1
Panel, 87 DIN mod. (3 rows x 29 mod.)	600		EH6029X	1/1
Panel, 24 DIN mod.	150	600	EH1524X	1/1
	200		EH2024X	1/1
Panel, 72 DIN mod. (3 rows x 24 mod.)	600		EH6025X	1/1
Panel, 36 DIN mod.	150	800	EH1536X	1/1
	200		EH2036X	1/1
Panel, 108 DIN mod. (3 rows x 36 mod.)	600		EH6036X	1/1

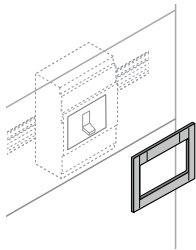

Tmax XT cover plate for DIN rail

Description	Type/ Order code	Pkg/ No. pcs
Cover plate for Tmax XT1 3P mounted on DIN rail	AD3301	1/1
Cover plate for Tmax XT1 4P mounted on DIN rail	AD3302	1/1
Cover plate for Tmax XT3 3P mounted on DIN rail	AD3303	1/1
Cover plate for Tmax XT3 4P mounted on DIN rail	AD3304	1/1

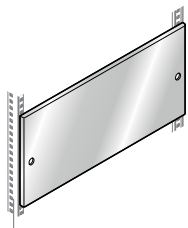

MD1600
MD1800
MD2000

Blind panels for apparatuses

12/10 stainless steel blind panel. The working dimension of the enclosure is always 100mm less than the total height of the enclosure.

Description	Dimensions (mm)		Type/ Order code	Pkg/ No. pcs	
	H	W			
Blind panel	50	600	EH0562X	1/1	
Blind panel	100		EH1062X	1/1	
Blind panel	150		EH1562X	1/1	
Blind panel	200		EH2062X	1/1	
Blind panel	300		EH3063X	1/1	
Blind panel	400		EH4062X	1/1	
Blind panel	500		EH5062X	1/1	
Blind panel	600		EH6062X	1/1	
Blind panel	50		800	EH0582X	1/1
Blind panel	100			EH1082X	1/1
Blind panel	150			EH1582X	1/1
Blind panel	200			EH2082X	1/1
Blind panel	300			EH3082X	1/1
Blind panel	400			EH4082X	1/1
Blind panel	500			EH5082X	1/1
Blind panel	600			EH6082X	1/1

ISX modular cabinets

Ordering codes

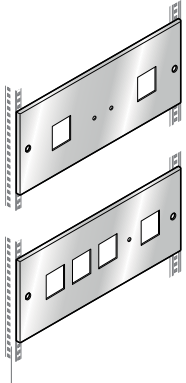

MD1600
MD1800
MD2000

Panels for square measuring instruments

12/10 stainless steel panel with cut-outs for measuring instruments. The working dimension of the enclosure is always 100mm less than the total height of the enclosure.

Description	Dimensions (mm)		Type/ Order code	Pkg/ No. pcs
	H	W		
Panel for 2 instruments 72x72mm	200	600	EH2272X	1/1
Panel for 4 instruments 72x72mm	200		EH2472X	1/1
Panel for 2 instruments 96x96mm	200		EH2297X	1/1
Panel for 2 instruments 72x72mm	200	800	EH3272X	1/1
Panel for 2 instruments 96x96mm	200		EH3296X	1/1
Panel for 4 instruments 72x72mm	200		EH3472X	1/1
Panel for 4 instruments 96x96mm	200		EH3496X	1/1

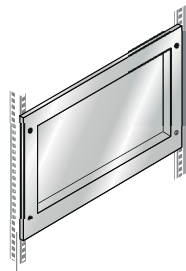

MD1600
MD1800
MD2000

Recessed opaque panels

15/10 stainless steel opaque panel. The working dimension of the enclosure is always 100mm less than the total height of the enclosure.

Description	Dimensions (mm)		Type/ Order code	Pkg/ No. pcs
	H	W		
Recessed opaque panel	200	600	EH2063X	1/1
Recessed opaque panel		800	EH2083X	1/1
Recessed opaque panel	300	600	EH3064X	1/1
Recessed opaque panel		800	EH3083X	1/1
Recessed opaque panel	400	600	EH4064X	1/1
Recessed opaque panel		800	EH4083X	1/1
Recessed opaque panel	500	600	EH5063X	1/1
Recessed opaque panel		800	EH5084X	1/1
Recessed opaque panel	600	600	EH6063X	1/1
Recessed opaque panel		800	EH6084X	1/1

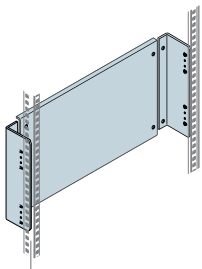

MD1600
MD1800
MD2000

Opaque apparatus holder back plates

15/10 thick opaque apparatus holder back plate. Fixed directly on uprights MD1800 or MD2000. The working dimension is always 100mm less than the total height of the enclosure.

Description	Dimensions (mm)		Type/ Order code	Pkg/ No. pcs
	H	W		
Opaque apparatus holder back plate	200	600	EH2065	1/1
Opaque apparatus holder back plate	300		EH3065	1/1
Opaque apparatus holder back plate	400		EH4065	1/1
Opaque apparatus holder back plate	200	800	EH2085	1/1
Opaque apparatus holder back plate	300		EH3085	1/1
Opaque apparatus holder back plate	400		EH4085	1/1

ISX modular cabinets

Ordering codes

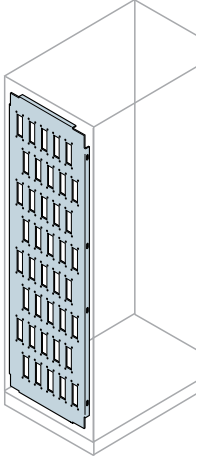

Connector holder panel

20/10 thick galvanised sheet steel panel prepared with drilled holes for 24-pole connectors.

Total No. of holes	No. rows/holes	Dimensions (mm)		Type/Order code	Pkg/No. pcs
		H	W		
Connector holder panel					
36	9/4	1800	9/4	EE1852	1/1
45	9/5		9/5	EE1862	1/1
40	10/4	2000	10/4	EE2052	1/1
50	10/5		10/5	EE2062	1/1

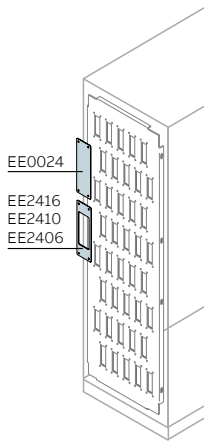

Connector holder panel

20/10 thick galvanised sheet steel panel prepared with drilled holes for 24-pole connectors.

Description	Type/Order code	Pkg/No. pcs
10 x 24 pole connector closing plates	EE0024	1/1
5 plates for reducing connectors from 24 to 16 poles	EE2416	1/1
5 plates for reducing connectors from 24 to 10 poles	EE2410	1/1
5 plates for reducing connectors from 24 to 6 poles	EE2406	1/1

EE0024
EE2416
EE2410
EE2406

ISX modular cabinets

Ordering codes

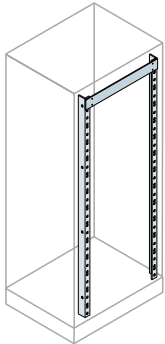

EG1800
EG2000
EG1880
EG2080

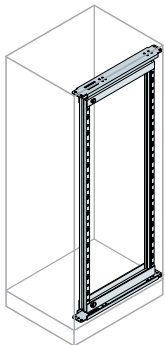

EG1801K
EG2001K

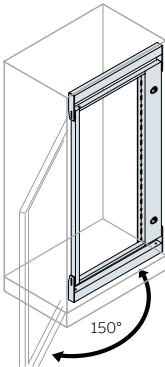

EG1803K
EG2003K

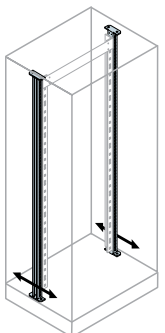

EM1804
EM2004

19" rack frames

The fixed frames are made of 20/10 galvanised steel. Centred and eccentric swing frames are made of 20/10 steel painted in RAL 7035 and are complete with handle and lock with double tongue key. Swing frame standard opening is 150°, hinged on the right or the left.

Description	Dimensions (mm)		Type/ Order code	Pkg/ No. pcs
	H	W		
Fixed rack frame 38HE	1800	600	EG1800	1/1
Fixed rack frame 38HE		800	EG1880	1/1
Fixed rack frame 42HE	2000	600	EG2000	1/1
Fixed rack frame 42HE		800	EG2080	1/1
Centred swing rack frame 36HE	1800	600	EG1801K	1/1
Eccentric swing rack frame 34HE		800	EG1803K	1/1
Centred swing rack frame 40HE	2000	600	EG2001K	1/1
Eccentric swing rack frame 38HE		800	EG2003K	1/1

Uprights for adjusting 19" rack frames depth

Description	Dimensions (mm)		Type/ Order code	Pkg/ No. pcs
	H			
No. 2 uprights for adjusting fixed rack frame depth	1800		EM1804	1/2
No. 2 uprights for adjusting fixed rack frame depth	2000		EM2004	1/2

ISX modular cabinets

Ordering codes

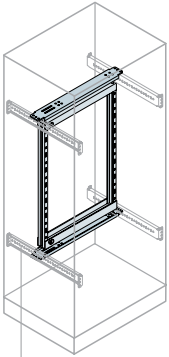

EB0400
EB0500
EB0600
EB0800

Partial swing 19" rack frames

Description	Dimensions (mm)		Type/ Order code	Pkg/ No. pcs
	H	W		
Partial swing rack frame 9HE	500	600	EG0500K	1/1
Partial swing rack frame 18HE	900	600	EG0900K	1/1
Partial swing rack frame 27HE	1300	600	EG1300K	1/1

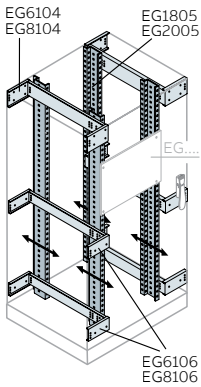

EG6104
EG8104

EG1805
EG2005

EG6106
EG8106

19" rack frames for server cabinet

The server cabinet 19" rack frame is made of 20/10mm galvanised sheet steel and is fixed on the special crosspieces. Depth adjustable.

Description	Dimensions (mm)		Type/ Order code	Pkg/ No. pcs
	H	W		
No. 2 cranked section 19" rack uprights	1800	800	EG1805	1/2
No. 2 cranked section 19" rack uprights	2000	800	EG2005	1/2

19" Server rack frame fixing crosspieces

Description	Dimensions (mm)		Type/ Order code	Pkg/ No. pcs
	D			
No. 2 upper crosspieces	600		EB6104	1/2
No. 2 upper crosspieces	800		EB8104	
No. 2 central/lower crosspieces	600		EB6106	1/2
No. 2 central/lower crosspieces	800		EB8106	

ISX modular cabinets

Ordering codes

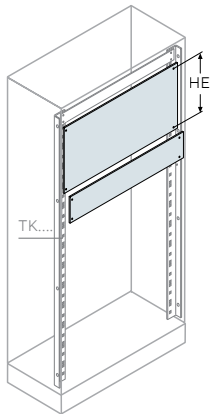

Opaque aluminium panels for 19" rack frames

Opaque compensation panels made of 30/10 thick opaque natural-coloured anodised aluminium, with 465mm centre-to-centre distance between holes.

Description	Dimensions (mm)		Type/ Order code	Pkg/ No. pcs
	H			
Panel for 19" rack frame 1HE	44,45		EG1991	1/1
Panel for 19" rack frame 2HE	89		EG1902	1/1
Panel for 19" rack frame 3HE	133		EG1903	1/1
Panel for 19" rack frame 4HE	177,5		EG1904	1/1
Panel for 19" rack frame 5HE	222		EG1905	1/1
Panel for 19" rack frame 6HE	266,5		EG1906	1/1
Panel for 19" rack frame 7HE	311		EG1907	1/1
Panel for 19" rack frame 8HE	355,5		EG1908	1/1
Panel for 19" rack frame 9HE	400		EG1909	1/1
Panel for 19" rack frame 10HE	444,5		EG1910	1/1
Panel for 19" rack frame 11HE	488		EG1911	1/1
Panel for 19" rack frame 12HE	533		EG1912	1/1
Panel for 19" rack frame 13HE	577,5		EG1913	1/1
Panel for 19" rack frame 14HE	622		EG1914	1/1
Panel for 19" rack frame 15HE	666		EG1915	1/1
Panel for 19" rack frame 16HE	711		EG1916	1/1
Panel for 19" rack frame 17HE	755,5		EG1917	1/1
Panel for 19" rack frame 18HE	800		EG1918	1/1
Panel for 19" rack frame 19HE	844,5		EG1999	1/1
Panel for 19" rack frame 20HE	889		EG1920	1/1

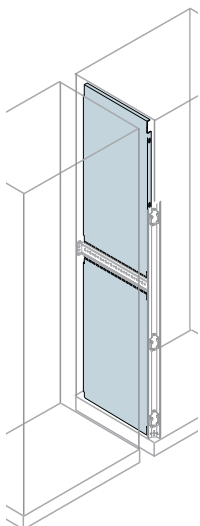

Vertical partition panels for side by side structures

20/10 thick galvanised sheet steel panel divided into two parts. When the side crosspiece H=48mm is present, use the pre-cut areas.

Description	Dimensions (mm)		Type/ Order code	Pkg/ No. pcs
	H	W		
Vertical partition panel	1800	400	EE1841	1/1
Vertical partition panel		500	EE1851	1/1
Vertical partition panel		600	EE1861	1/1
Vertical partition panel	2000	400	EE2041	1/1
Vertical partition panel		500	EE2051	1/1
Vertical partition panel		600	EE2061	1/1

ISX modular cabinets

Ordering codes

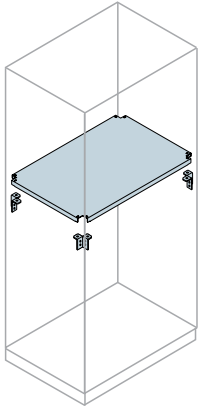

Horizontal partition panels

15/10 thick galvanised sheet steel panel for horizontally separating the various components inside the structure.

Description	Dimensions (mm)		Type/ Order code	Pkg/ No. pcs
	W	D		
Horizontal partition panel	600	400	EE6041	1/1
Horizontal partition panel	800		EE8041	1/1
Horizontal partition panel	1000		EE1041	1/1
Horizontal partition panel	600	500	EE6051	1/1
Horizontal partition panel	800		EE8051	1/1
Horizontal partition panel	1000		EE1051	1/1
Horizontal partition panel	600	600	EE6061	1/1
Horizontal partition panel	800		EE8061	1/1
Horizontal partition panel	1000		EE1061	1/1
Horizontal partition panel sliding ⁽¹⁾	600	600	EE1003K	1/1
Horizontal partition panel sliding ⁽¹⁾	800	600	EE1004K	1/1

⁽¹⁾ Including fixing crosspieces and relative accessories. Do not fit with double doors W=800/1000mm.

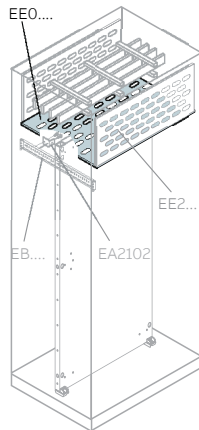

Horizontal busbar segregations

Drilled sheet metal panels (IP20), for busbar system segregation. Cannot be fitted in cabinets with compartment configurations or with DIN frame.

Description	Dimensions (mm)		Type/ Order code	Pkg/ No. pcs
	W	D		
Horizontal segregation	600	400	EE0640	1/1
Horizontal segregation		500	EE0650	1/1
Horizontal segregation		600	EE0660	1/1
Horizontal segregation	800	400	EE0840	1/1
Horizontal segregation		500	EE0850	1/1
Horizontal segregation		600	EE0860	1/1
Horizontal segregation	1000	400	EE1040	1/1
Horizontal segregation		500	EE1050	1/1
Horizontal segregation		600	EE1060	1/1

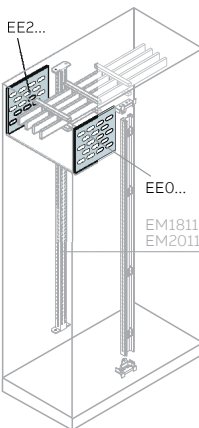

Vertical busbar segregations

Drilled sheet metal panels (IP20), for busbar system segregation.

Description	Dimensions (mm)		Type/ Order code	Pkg/ No. pcs
	H	W		
Pair of vertical segregations	200	600	EE2600	1/2
Pair of vertical segregations	200	800	EE2800	1/2
Pair of vertical segregations	200	1000	EE2100	1/2

ISX modular cabinets

Ordering codes

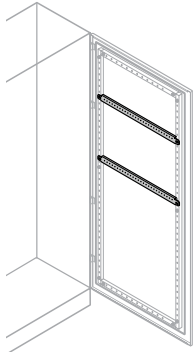

Horizontal reinforcement sections for doors

Crosspieces made of galvanised steel with drilling with 25mm pitch, for fixing accessories (e.g.: wiring ducts) inside opaque doors. Fixed to the door reinforcement tube.

Description	Dimensions (mm)		Type/ Order code	Pkg/ No. pcs
	W	H		
No. 2 horizontal sections h=35mm	600	35	EB1041	1/2
No. 2 horizontal sections h=35mm	800	35	EB1042	1/2
No. 2 horizontal sections h=35mm	1000	35	EB1043	1/2

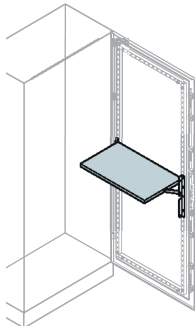

Folding shelves for door

Description	Dimensions (mm)		Type/ Order code	Pkg/ No. pcs
	W	D		
Shelf 437x244mm (WxD)	600	244	EV1060K	1/1
Shelf 637x244mm (WxD)	800	244	EV1061K	1/1

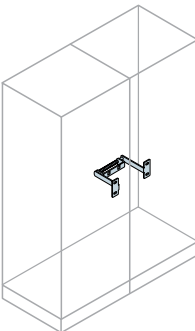

Door anti-closure and locking device

Description	Type/ Order code	Pkg/ No. pcs
Door anti-closure device	EV0005	1/1

Door lock

If several cabinets are placed side by side, this prevents one door from being opened before the adjacent door has been opened. Therefore, opening of the doors in an entire battery of cabinets placed side by side can be constrained to the opening of a single door. Can be fitted on opaque doors $W \geq 600$ mm with the same opening direction.

Description	Type/ Order code	Pkg/ No. pcs
Door lock	EV1160	1/1

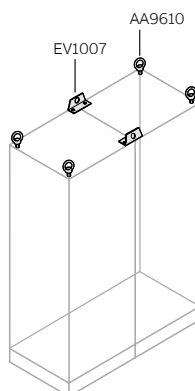

Lifting eyebolts and reinforcements

These allow cabled enclosure handling. The lifting eyebolts are made of white passivated galvanised steel. The lifting reinforcements are painted grey RAL7012 with a textured finish.

Description	Type/ Order code	Pkg/ No. pcs
No. 4 eyebolts M12	AA9610	1/4
No. 2 lifting reinforcements	EV1007	1/2

ISX modular cabinets

Ordering codes

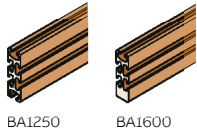
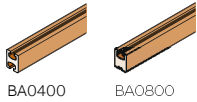

Distribution busbars with shaped section

Description	Dimensions (mm)		Pkg/ No. pcs
	W	Type/ Order code	
Busbar In=400A	1730	BA0400	1/1
Busbar In=800A	1730	BA0800	1/1
Busbar In=1250A	1730	BA1250	1/1
Busbar In=1600A	1730	BA1600	1/1

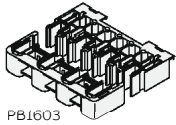
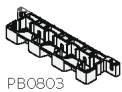

Busbar holders for busbars with shaped section

For use with crosspieces H=48mm to be drilled (see page 4/17).

Description	Type/ Order code	Pkg/ No. pcs
Linear busbar holder In=800A - 35kA	PB0803	1/1
Linear busbar holder up to In=1600A - 65kA	PB1603	1/1

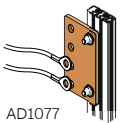
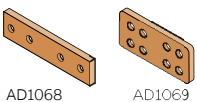

Joints for busbars

Description	Type/ Order code	Pkg/ No. pcs
No. 4 joints for 800A busbars with shaped section (with 800/1250/1600A busbars)	AD1068	1/4
No. 4 joints for 1250/1600A busbars with shaped section (with 1250/1600A busbars)	AD1069	1/4
No. 4 x 400A copper branch joints	AD1077	1/4

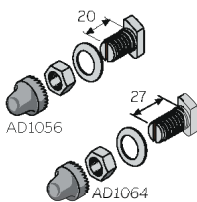

Hammer seal screws

Complete with screw covering cap.

Description	Type/ Order code	Pkg/ No. pcs
No. 12xM8 screws - W=20mm for cable terminal	AD1056	1/12
No. 12xM8 screws - W=27mm for plates up to 10mm	AD1064	1/12

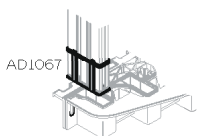
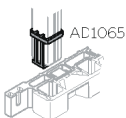

Resting bases

Description	Type/ Order code	Pkg/ No. pcs
No. 4 resting bases for 400/800A busbars	AD1065	1/4
No. 4 resting bases for 1250/1600A busbars	AD1067	1/4



Busbar adapter

Description	Type/ Order code	Pkg/ No. pcs
No. 4 adapters for busbars In =400/800A with busbar holder (PB1603)	AD1066	1/4

ISX modular cabinets

Ordering codes

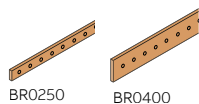

Flat busbars

Description	Dimensions (mm)	Type/ Order code	Pkg/ No. pcs
	W		
No. 2 busbars In=250A section 15x5mm	1750	BR0250	1/2
No. 2 busbars In=400A section 25x5mm	1750	BR0400	1/2
No. 2 busbars In=630A section 30x10mm	1750	BR0630	1/2

Flexible busbars

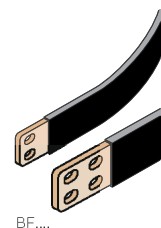

BF...

Description	Dimensions (mm)	Type/ Order code	Pkg/ No. pcs
	W		
No. 2 flexible busbars, section 20x3 In=250A	2000	BF1602	1/2
No. 2 flexible busbars, section 20x5 In=400A	2000	BF2502	1/2
No. 2 flexible busbars, section 24x6 In=500A	2000	BF4002	1/2
No. 2 flexible busbars, section 32x5 In=630A	2000	BF4012 ⁽¹⁾	1/2
No. 2 flexible busbars, section 40x8 In=1000A	2000	BF6302	1/2
No. 2 flexible busbars, section 50x10 In=1250A	2000	BF8002	1/2

⁽¹⁾ Only for circuit breakers with extended front terminals or rear terminals.

Busbar holders

For use with crosspieces H=48mm to be drilled (see page 4/19).

BP0630

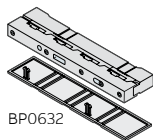

BP0632

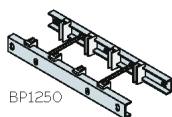

BP1250

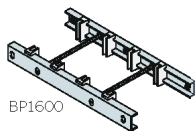

BP1600

Description	Type/ Order code	Pkg/ No. pcs
2 flat busbar holders In=250A-630A - 32kA	BP0630	1/2
2 terminal covers for flat busbar holders BP0630	BP0632	1/2
2 busbar holders for 5mm thick busbars	BP1250	1/2
2 busbar holders for 10mm thick busbars	BP1600	1/2

ISX modular cabinets

Ordering codes

Closing systems

May substitute standard fasteners for the external doors. The inserts are interchangeable and easily substituted by loosening a single nut.

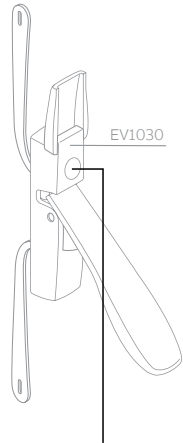

EV1030

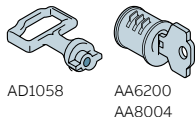

AD1058

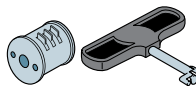
AA6200
AA8004

AA6160

AA1570

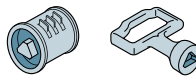

AA6120

AA1560

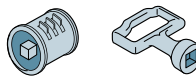

AA6140

AA6141

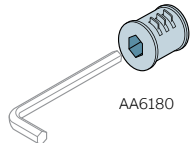

AA6180

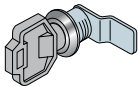
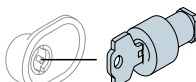
AA8001X
External door double
door version

EV1008

EV1036
EV1037

Description	Type/ Order code	Pkg/ No. pcs
Spare parts and accessories for EV1030 handle		
Handle complete with lock	EV1030	1/1
Zamak (Zn+Al+Mg) alloy key for double tongue insert, for external door, single door version	AD1058	1/1
Yale insert and key for external door, single door version	AA6200	1/1
Ronis E739 insert and key for external door, single door version	AA8004	1/1
Ronis insert 455 and key	PIRH0455	1/1
Ronis insert 2432E and key	PIRH2432	1/1
Ronis insert 1242E and key	PIRH1242	1/1
Ronis insert 405 and key	PIRH0405	1/1
FIST (FIAT) insert for external door, single door version	AA6160	1/1
FIAT key for external door, single door version	AA1570	1/1
Triangular insert, 6.4 male on Ø7.6, for external door, single door version	AA6120	1/1
Key for triangular insert for external door, single door version	AA1560	1/1
Square insert, 7 male, for external door, single door version	AA6140	1/1
Key for square insert for external door, single door version	AA6141	1/1
Hexagonal insert, 8mm socket type; key not available; for external door, single door version	AA6180	1/1
Plastic key for triangular insert AA5200 for external door, double doors version	AA6190	1/1
Box Ø19mm double tongue, chrome-finished plastic and key for external door, double doors version	AA8001X	1/1
Spare parts and accessories for EV1008 box		
Box with double tongue insert made of plastic with key for inner door	EV1008	1/1
Single code Yale insert for inner door	EV1036	1/1
Ronis 455 insert for inner door	EV1037	1/1
3mm double tongue insert for inner door	EV1039	1/1
Double tongue insert for handle/closing box	AA6100	1/1

ISX modular cabinets

Ordering codes

Spare parts

Description	Dimensions (mm)		Type/ Order code	Pkg/ No. pcs
	H	W		
Opaque door	1600	600	TC1606X	1/1
Opaque door		800	TC1608X	1/1
Opaque door	1800	600	TC1806X	1/1
Glass door		600	TT1806X	1/1
Opaque door		800	TC1808X	1/1
Glass door		800	TT1808X	1/1
Opaque door		1000	TC1810X	1/1
Glass door		1000	TT1810X	1/1
Opaque door with handle for double doors version		600+600	TC1812DX	1/1
Opaque door with overlapping closing for double doors version		600+600	TC1812SX	1/1
Opaque door	2000	600	TC2006X	1/1
Glass door		600	TT2006X	1/1
Opaque door		800	TC2008X	1/1
Glass door		800	TT2008X	1/1
Opaque door		1000	TC2010X	1/1
Glass door		1000	TT2010X	1/1
Opaque door with handle for double doors version		600+600	TC2012DX	1/1
Opaque door with overlapping closing for double doors version		600+600	TC2012SX	1/1
Rear panel	1600	600	TE1660X	1/1
Rear panel		800	TE1680X	1/1
Rear panel	1800	600	TE1860X	1/1
Rear panel		800	TE1880X	1/1
Rear panel		1000	TE1810X	1/1
Rear panel		1200	TE1812X	1/1
Rear panel	2000	600	TE2060X	1/1
Rear panel		800	TE2080X	1/1
Rear panel		1000	TE2010X	1/1
Rear panel		1200	TE2012X	1/1

Chapter 5

Common accessories to all series

5-2 Ordering codes

Common accessories to all series

Ordering codes

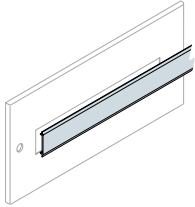

SRX enclosures - AMX monobloc cabinets - ISX modular cabinets

Accessories for modular panels

RAL7035 coloured hole covering strip

Description	Type/ Order code	Pkg/ No. pcs
10 hole covers W=2000mm	AD1086	1/10
3 hole covers 24 DIN modules W=600	AD1088	1/3
3 hole covers 36 DIN modules W=800	AD1089	1/3

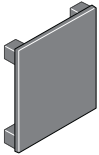

EV1137

EV1135
EV1136

Closing plugs for instrument holder panels

Description	Type/ Order code	Pkg/ No. pcs
N° 10 closing plugs for instrument holder panel 72x72mm	EV1135	1/10
N° 5 closing plugs for instrument holder panel 96x96mm	EV1136	1/5
50 closing plugs for pushbuttons Ø22mm	EV1137	1/50

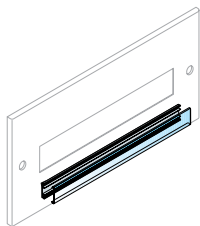
AD1101-AD1102
AD1103-AD1104

Adhesive label holder

Description	Dimensions (mm)		Type/ Order code	Pkg/ No. pcs
	W	H		
N° 20 label holders 18 DIN mod.	325	18	EH2118	1/20
N° 20 label holders 29 DIN mod.	525	29	EH2129	1/20
N° 20 label holders 24 DIN mod.	432	24	AD1600	1/20
N° 20 label holders 36 DIN mod.	634	36	AD1800	1/20

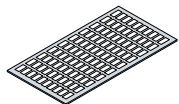
EH2118-EH2129
AD1600-AD1800

Adhesive label holder

Description	No. of DIN mod.	Type/ Order code	Pkg/ No. pcs
N° 288 labels 1 DIN mod.	1	AD1101	1/288
N° 192 labels 2 DIN mod.	2	AD1102	1/192
N° 96 labels 3 DIN mod.	3	AD1103	1/96
N° 96 labels 4 DIN mod.	4	AD1104	1/96

Common accessories to all series

Ordering codes

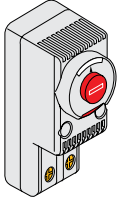

SRX enclosures - AMX monobloc cabinets - ISX modular cabinets

IP20 thermostat

Conforms to EN 60730-1, EN 60730-2-9, UL and cURus approval, degree of protection IP20. Grey RAL 7035 colour; electrical life 100,000 cycles. Dimensions (h_xw_xd) 68x29x44mm, can be mounted on all types of DIN rails. The version with NO (normally open) contact allows a circuit to be made, activating ventilation, air conditioning, or alarms. The version with NC (normally closed) contact allows a circuit to be broken, disconnecting any anticondensation heating elements.

Description	Standard power supply ~ 50-60 Hz	Type/ Order code	Pkg/ No. pcs
NO ventilation thermostat	110/250	EN0101K	1/1
NC heating thermostat	110/250	EN0102K	1/1

Type	Power supply	Contact capacity Load Ω	Load L	Temperature scale	Type of contact	Weight
EN0101K	110/250~	10A	2A	-10 +80 °C	NO	48g
EN0102K	110/250~	10A	2A	-10 +80 °C	NO	48g

Markings

Description	Type/ Order code	Pkg/ No. pcs
N° 490 adhesive labels Ø12mm N symbol	EV1150	1/490
N° 490 adhesive labels Ø12mm L1 symbol	EV1151	1/490
N° 490 adhesive labels Ø12mm L2 symbol	EV1152	1/490
N° 490 adhesive labels Ø12mm L3 symbol	EV1153	1/490
N° 490 adhesive labels Ø12mm T symbol	EV1154	1/490
N° 10 triangular adhesive labels 125mm with 400V arrow symbol	EV1155	1/10
N° 300 triangular adhesive labels 20mm with arrow symbol	EV1156	1/300

Apparatus screws

Description	Type/ Order code	Pkg/ No. pcs
N° 1000 Phillips (cross head slot piercing screws 4.2x13mm	EV1100	1/1100
N° 1000 cross head slot piercing screws 4.2x19mm	EV1101	1/1000
N° 20 M6 cage nuts with front insertion	AD1036	1/20
N° 50 M6 three-lobe spare screws L=16mm	AD1033	1/50

Wiring duct support brackets

Description	Type/ Order code	Pkg/ No. pcs
100 wiring duct support brackets on structure uprights	EV1130	1/100
100 wiring duct support brackets on pushbuttons Ø22	EV1131	1/100

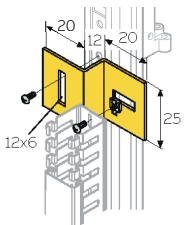
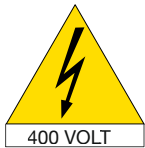
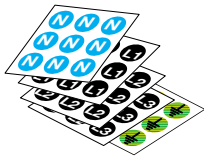

EV1130

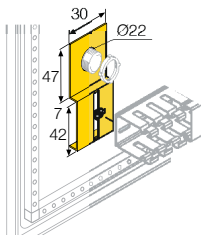



EV1131



Common accessories to all series

Ordering codes

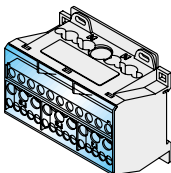
SRX enclosures - AMX monobloc cabinets - ISX modular cabinets

Modular dividers

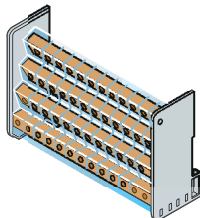
Four-poles	Code	AD1004
	Mark	
	In	(A) 125
	Icw	(kA) 10
	Ipk	(kA) 24
	Version	poles 4.2
	Installation	DIN35/plate
	Power supplye	min. 6
	Ø cable (mm ²)	max 35
	No.outgoing feeder (mm ²) Ø cable	With cable lugs 5L, 4Nx1,5-6mm ² 2L, 6Nx4-10mm ² 1L, 1Nx6-25mm ² Without cable lugs 5L, 4Nx1,5-6mm ² 2L, 6Nx4-10mm ² 1L, 1Nx6-35mm ²
	Dimensions (mm) HxWxD	74.5x98x45
	No. DIN modules	5,5
	Rated service voltage Ue	(V) 1000 Vac/1500 Vdc
	Degree of protection	IP 20

Four-poles	Code	AD1028
	Mark	
	In	(A) 125
	Icw	(kA) 4.2
	Ipk	(kA) 25
	Version	poles 4
	Installation	DIN35/plate
	Power supplye	min. 6
	Ø cable (mm ²)	max 25 with cable terminal
	No.outgoing feeder (mm ²) Ø cable	Rigid cable 7x1,5-10mm ² 2x6-25mm ² With cable lugs 7x1,5-10mm ² 2x6-16mm ² Without cable lugs 7x2,5-16mm ² 2x6-35mm ²
	Dimensions (mm) HxWxD	93x89x48
	No. DIN modules	5
	Rated service voltage Ue	(V) 440
	Degree of protection	IP 20

Common accessories to all series

Ordering codes

Modular dividers

Four-poles

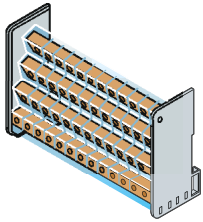

Code		AD1029
Mark		CE CE
In	(A)	125
Icw	(kA)	4.2
Ipk	(kA)	25
Version	poles	4
Installation		DIN35/plate
Power supply	min.	6
Ø cable (mm ²)	max	25 with cable terminal
No.outgoing feeder		Rigid cable
(mm ²) Ø cable		9x1,5-10mm ²
		2x1,5-16mm ²
		2x6-25mm ²
		With cable lugs
		2x1,5-6mm ²
		9x1,5-10mm ²
		2x6-16mm ²
		Without cable lugs
		11x2,5-16mm ²
		2x6-35mm ²
Dimensions	(mm)	96x126x48
HxWxD		
No. DIN modules		7
Rated service	(V)	440
voltage Ue		
Degree of	IP	20
protection		

Four-poles

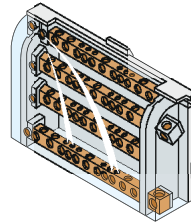

Code		AD1027
Mark		CE CE
In	(A)	AD1027
Icw	(kA)	160
Ipk	(kA)	6.2
Version	poles	20
Installation		4
Power supply	min.	DIN35
Ø cable (mm ²)	max	10
No.outgoing feeder		50
(mm ²) Ø cable		Rigid cable
		8x2,25-25mm ²
		1x10-50mm ²
		3x16-35mm ²
		With cable lugs
		8x2,5-16mm ²
		3x6-25mm ²
		1x10-35mm ²
		Without cable lugs
		8x6-16mm ²
		3x6-25mm ²
		1x10-35mm ²
Dimensions	(mm)	90x160.5x50
HxWxD		
No. DIN modules		9
Rated service	(V)	440
voltage Ue		
Degree of	IP	20
protection		

Common accessories to all series

Ordering codes

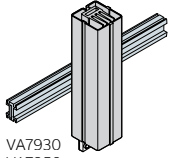

VA7930
VA7950
VA7975
VA7910

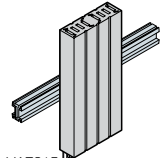

VA7915

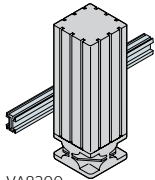

VA8300

SRX enclosures - AMX monobloc cabinets - ISX modular cabinets

Heater for IP20 electrical switchboards

Their use prevents condensation in the electric cabinets. They consist of a heating element (PTC thermistor) inserted in an aluminium alloy ground plate. The PTC thermistor is a component which modifies its impedance according to the operating temperature. It is intrinsically stable and ensures primary safety features for the heater and service stability.

The main qualities of the heaters using PTC are:

- electrical absorption (or dissipated power) which is almost constant in the range of power supply voltage between 100 and 250V;
- electrical absorption bound by inverse law to the trend of the ambient temperature.

The special tubular geometry of the ground plate allows efficient thermal exchange with the heating element. This allows high powers and limited overall dimensions (especially in width and depth); Snap-on assembly on 35 mm DIN rail. Requires a thermostat.

Description	Dimensions (mm)			Type/ Order code	Pkg/ No. pcs
	H	W	D		
Anti-condensation heater 30W, 110-240V ac-dc	115	42	42	VA7930 ⁽¹⁾	1/1
Anti-condensation heater 50W, 110-240V ac-dc	165	42	42	VA7950 ⁽¹⁾	1/1
Anti-condensation heater 75W, 110-240V ac-dc	210	42	42	VA7975 ⁽¹⁾	1/1
Anti-condensation heater 100W, 110-240V ac-dc	165	42	51	VA7910	1/1
Anti-condensation heater 150W, 110-240V ac-dc	146	82	51	VA7915	1/1
Anti-condensation heater with fan 300W, 230V ac-dc	148	82	91	VA8300	1/1

⁽¹⁾ Can also be used for SRX enclosures.

Detached, exposed on all sides

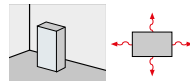

For closed to a wall structures

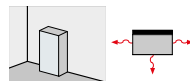

Left or right exposed structure

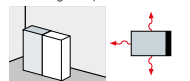

Left or right closed to a wall structure

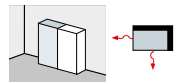

Central exposed structure

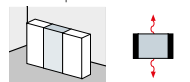

Central closed to a wall structure



Central closed to a wall structure, with covered roof



All the heaters with PTC absorb a higher power than the rated one on inrush according to a transitory which lasts a few tenths of a second. If the heaters are to be supplied by means of an auxiliary transformer, its apparent power must be sized taking 1.5 times the rated power of the heaters with natural aeration and twice those with forced ventilation into consideration.

IEC 890 method for calculating the effective cooling surface (CEI 17-43 method)

The total power dissipation P of an enclosure is linked to the exchange effective dissipating surface S, the ΔT difference between the inner and outer temperature and the k coefficient of heat exchange relative to the material of the enclosure:

$$P = k * \Delta T * S$$

k = 5,5 for painted steel

ΔT = T1-T2;

T1 = dew point temperature (on average 25°C)

T2 = minimum ambient temperature.

The exchange surface S can be calculated using the following table taken from the CEI 17-43.

Disposition of the cabinet	Calculating the enclosure surface S (mm ²)	Dimensions (m)
Detached, exposed on all sides	$S = 1,8 \times H \times (L+P) + 1,4 \times L \times P$	L = width H = height P = depth
For closed to a wall structures	$S = 1,4 \times L \times (H+P) + 1,8 \times P \times H$	
Left or right exposed structure	$S = 1,4 \times P \times (H+L) + 1,8 \times L \times H$	
Left or right closed to a wall structure	$S = 1,4 \times H \times (P+L) + 1,4 \times L \times P$	
Central exposed structure	$S = 1,8 \times L \times H + 1,4 \times L \times P + P \times H$	
Central closed to a wall structure	$S = 1,4 \times L \times (H+P) + P \times H$	
Central closed to a wall structure, with covered roof	$S = 1,4 \times L \times H + 0,7 \times L \times P + P \times H$	

Using a TM2865X enclosure, in "for closed to a wall structures" case we will obtain:

T1 = 25 °C, T2 = 20 °C, K = 5,5 T = (25-20) = 5 °C, S = 3,2m²

The total power dissipation P obtained will be:

$$P = k * T * S = 88W$$

The recommended heater is VA7910 (100W)

Common accessories to all series

Ordering codes

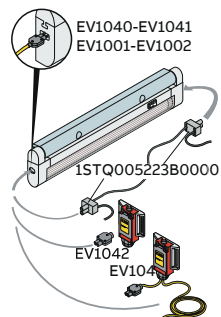

AMX monobloc cabinets - ISX modular cabinets

Fluorescent lamps

The 8 and 13 W fluorescent lamps are complete with fixing bracket and can be integrated with the voltage detector devices. They have the following characteristics:

- rotatable 180 degrees about the axis of the aluminium bracket
- the shape of the lamp and the electronic tube guarantee very wide light emission and a 70% increase compared with traditional lamps. This means that an 8W lamp is comparable to a 14W one, and the 13W version to a 18/21W traditional lamp
- possibility of fitting up to 5 elements in series (fig. 1). The chain of lamps can be controlled by a single micro switch, simplifying installation operations and reducing the number of cables for connection of the elements

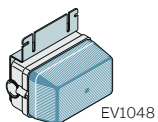
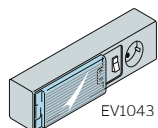

Description	Type/ Order code	Pkg/ No. pcs
Fluorescent lamp 8W-220/240V W=342mm	EV1040	1/1
Fluorescent lamp 13W-220/240V W=574mm	EV1041	1/1
System for positioning limit switch + connector (to be cabled)	EV1042	1/1
5 female two-pole connectors	EV1044	1/5
Two-pole cable L=10 metres	EV1045	1/1
Limit switch and cabled two-pole connector	EV1047*	1/1
Fluorescent lamp + socket 11W-230V l=355mm, complete with magnetic support	EV1043	1/1
Incandescent ceiling light on bracket (without lamp)	EV1048	1/1
No.5 universal bipolar power connectors	1STQ 005223B0000	1/5

* The pack contains 2 cables L=1900mm and L=380mm.

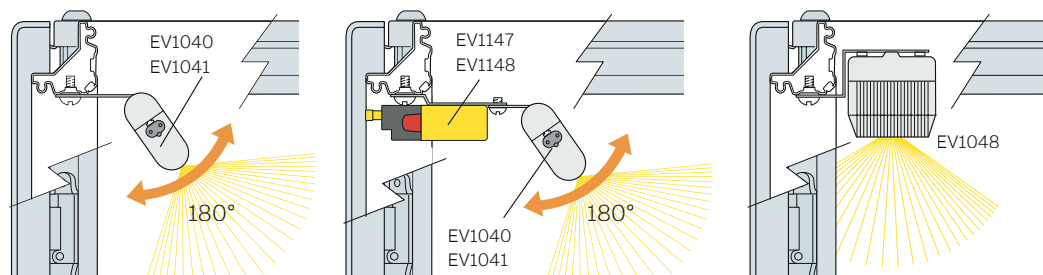
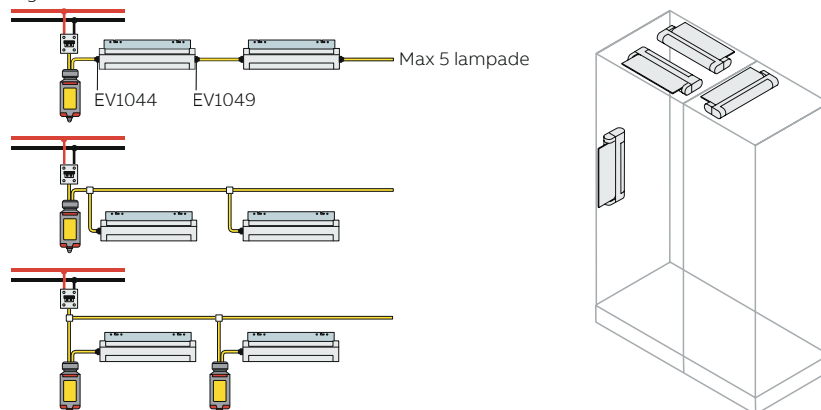

Fig. 1



Common accessories to all series

Ordering codes

AMX monobloc cabinets - ISX modular cabinets

Fluorescent lamps

Allows the passive safety level to be increased inside the electric panel boards, flashing when the door is opened. The basic version consists of a three-phase flashing light, three-pole limit switch and fixing bracket. Compared to the basic version, the one with an auxiliary circuit is completed with a mechanical interlock which activates the electric contacts to control the auxiliary circuits. The interlock is always fitted with a NC contact code EV1144 (NC installed with door closed) which allows supply of a current launching coil. A NC contact can be added code EV1144 (NC installed with door closed) to allow opening of an undervoltage coil. It is also possible to supply circuits relative to internal lighting and/or to turn off fans/air conditioners. NO contact EV1145 (NC installed with door closed) available. Order the fixing screws W=46mm code EV1146 separately for the additional contact.

Possibility of exclusion during the testing stage with relative automatic recover when the door has been closed. Conforms to the EN60947- 5-1 Standards, UL/CSA approved, operating temperature from -25 °C to +65 °C.

Flashing: terminal capacity max. 3mm², Ue/Ie auxiliary contact capacity: 110V/6A, 230V/3A, 400V/2A, 600V/1.2A.

Rated thermal current I_{th}: 10 A

Max. terminal capacity: 2x1.5mm² / 1x3mm²

Flashing signalling device:

- Single phase 110-400V DC/AC 50/60Hz power supply voltage
- Three-phase AC 220-690V 50/60Hz

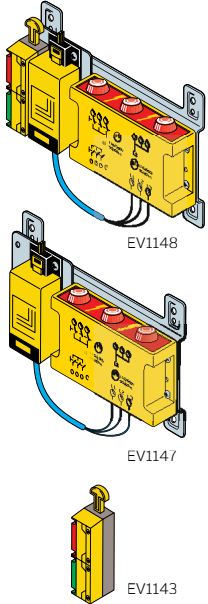

Description	Ue (V)	Ui (V)	Type/Order code	Pkg/No. pcs
Voltage detector device	380/600	690	EV1147	1/1
Voltage detector device + interlock + 1 NC contact	380/600	690	EV1148	1/1
Interlock + 1 NC contact			EV1143	1/1
1 NC contact			EV1144	1/1
1 NO contact			EV1145	1/1
Screw W=46mm x 2 contacts			EV1146	1/1

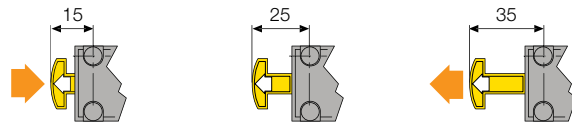

	Code	Closed door	Open door	Open door by pass
Position of contacts	EV1144	:]	:
	EV1145	[:	[

Common accessories to all series

Ordering codes

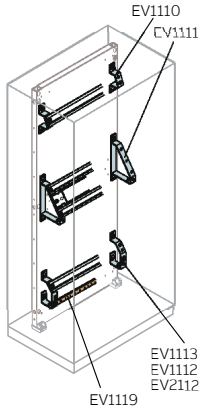

AMX monobloc cabinets - ISX modular cabinets

Angled supports for terminal boxes and earthing busbars

Description	Type/ Order code	Pkg/ No. pcs
N° 50 angled supports, 1 row of terminals	EV1110	1/50
N° 10 angled supports, 1 row of terminals	EV2110	1/10
N° 50 angled supports, 1 row of terminals + earth	EV1112	1/50
N° 10 angled supports, 1 row of terminals + earth	EV2112	1/10
N° 2 angled supports, 1 row of terminals + earth	EV1113	1/2
N° 10 angled supports, double row of terminals	EV1111	1/10

Shaped sections for accessories

Various types of universal sections for mounting any component or for anchoring cables.



TS4013



TS4011

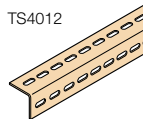

TS4012

TS4000-TS4001-TS4002
TS4003-TS4004

Description	Dimensions (mm)		Pkg/ No. pcs
	W	Type/ Order code	
N° 2 sections for structures	600	TS0060	1/2
N° 2 sections for structures	800	TS0080	1/2
N° 2 sections for structures	1000	TS0100	1/2
N° 2 sections for structures	1200	TS0120	1/2

Position switch

Conforms to the IEC 50047 Standard, IP65 degree of protection, UL/CSA approved, it can be mounted in all positions by means of the accessory provided. $U_i=500V$, Aux. contact $I_n=3A$ a $230V\sim$, $1.8A$ at $400V\sim$ (in AC-15 IEC 60947-5-1). Dimensions (h \times w \times d) 84 \times 30 \times 30mm.

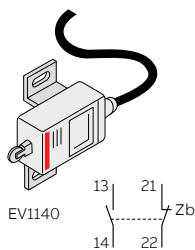

EV1140

Description	Type/ Order code	Pkg/ No. pcs
Door protective device for AMX	TA7100	
Door protective device for ISX	EV1140	

Diagram holder pockets RAL 7035

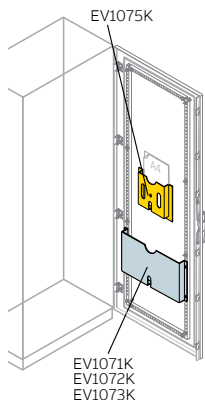

Description	Dimensions (mm)		Pkg/ No. pcs
	W	Type/ Order code	
Metal diagram holder pocket for door	600	EV1071K	1/1
Metal diagram holder pocket for door	800	EV1072K	1/1
Metal diagram holder pocket for door	1000	EV1073K	1/1
Plastic diagram holder pocket for A4		EV1075K ⁽¹⁾	1/1

⁽¹⁾ Can also be used for SRX enclosures.

Common accessories to all series

Ordering codes

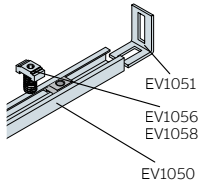

AMX monobloc cabinets - ISX modular cabinets

Cable anchoring brackets

Adjustable cable clamping bracket, can be fitted on sections with 10mm slot EV1050.

Description	Type/ Order code	Pkg/ No. pcs
No. 10 cable clamping brackets Ø9-16mm min-max	EV1090	1/10
No. 10 cable clamping brackets Ø16-30mm min-max	EV1091	1/10
No. 5 cable clamping brackets Ø30-48mm min-max	EV1092	1/5
No. 5 cable clamping brackets Ø48-72mm min-max	EV1093	1/5

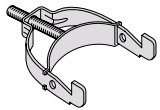

Aluminium sliding rails for general purposes

Description	Type/ Order code	Pkg/ No. pcs
No. 10 aluminium sections 30x15x1.8 - L=2000mm	EV1050	1/10
No. 25 fixing brackets for EV1050	EV1051	1/25
No. 100 M6 aluminium nuts for EV1050	EV1056	1/100
No. 100 M8 aluminium nuts for EV1050	EV1058	1/100

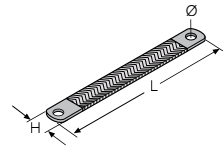

Earthing cables

Description	Dimensions (mm)		Type/ Order code	Pkg/ No. pcs
	H	W		
No. 5 cables, cross-section 16mm ² Ø7mm	17	200	AA6840	1/5
No. 5 cables, cross-section 16mm ² Ø7mm	17	300	AA6850	1/5
No. 5 cables, cross-section 25mm ² Ø9mm	22	200	AA6880	1/5
No. 5 cables, cross-section 25mm ² Ø9mm	22	300	AA6890	1/5

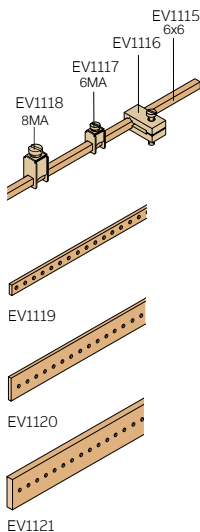

Aluminium sliding rails for general purposes

Description	Type/ Order code	Pkg/ No. pcs
Neutral/earthing busbar 6x6mm W=2000mm	EV1115	1/1
50 isolators for neutral/earthing busbar for EV1115	EV1116	1/50
100 terminals for cable Ø0.5-16mm ² for EV1115	EV1117	1/100
100 terminals for cable Ø4-35mm ² for EV1115	EV1118	1/100
2 busbars 20x5mm drilled and threaded M6 W=2000mm	EV1119	1/2
2 busbars 25x5mm drilled and threaded M6 W=2000mm	EV1120	1/2
2 busbars 50x5mm drilled and threaded M6 W=2000mm	EV1121	1/2
50 hexagonal isolators 30x30mm M6	EV1122	1/50
50 hexagonal isolators 30x30mm M8	EV1123	1/50
50 hexagonal isolators 36x50mm M6	EV1124	1/50
50 hexagonal isolators 36x50mm M8	EV1125	1/50

Common accessories to all series

Ordering codes

IP21/54

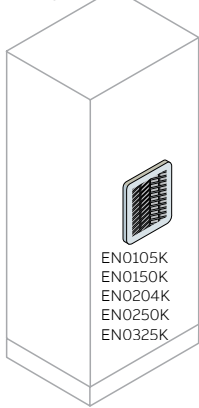

AMX monobloc cabinets - ISX modular cabinets

IP21/54 natural ventilation kit

Gratings made of insulating material (self-extinguishing ABS UL94V-0) RAL7035 colour, complete with high dust collection capacity filter cloth (600g/m²), able to reduce maintenance interventions (cleaning by means of washing in water or by beating). Degree of protection IP21 without filter, IP54 with filter according to IEC 60529, Type 1 without filter, Type 12 with filter according to UL approval 508 fitted with pre-assembled gasket seal. CE and cURus approval.

Air entry surface for ventilation		Dimensions (mm)		Type/ Order code	Pkg/ No. pcs
Without filter cm ²	With filter cm ²	W	H		
Grille+air passage filter kit					
27	6	105	105	EN0105K	1/1
53	10	150	150	EN0150K	1/1
121	22	204	204	EN0204K	1/1
225	32	250	250	EN0250K	1/1
317	55	325	325	EN0325K	1/1

IP56 Stainless steel hoods for ventilation kits

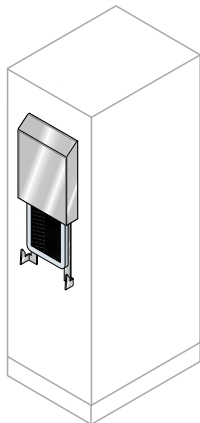

Description	Dimensions (mm)		Type/ Order code	Pkg/ No. pcs
	W	H		
Ventilation hood for EN1105K, EN2105K	105	105	EN0105X	1/1
Ventilation hood for EN1150K, EN2150K	150	150	EN0150X	1/1
Ventilation hood for EN1204K, EN2204K	204	204	EN0204X	1/1
Ventilation hood for EN1250K, EN2250K	250	250	EN0250X	1/1
Ventilation hood for EN2325K, EN3325K	325	325	EN0325X	1/1

Common accessories to all series

Ordering codes

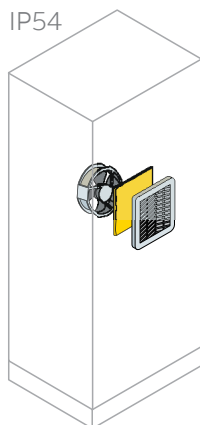

AMX monobloc cabinets - ISX modular cabinets

IP54 forced ventilation kit

Grilles made of insulating material (ABS self-extinguishing UL94V-0) RAL7035 colour, complete with filter cloth with high dust accumulation capacity (600g/m²), able to reduce maintenance interventions (cleaning by washing with water or beating). IP54 degree of protection with filter according to UL approval 508 fitted with pre-mounted tightness gasket. Operating temperature -10 °C + 50 °C, for noise values see page 8/50. The fans allow reversible flow of air. CE and cURus (see mark) approval.

Consumption 50/60Hz (W)	Capacity 50/60Hz (m ³ /h)	Dimensions (mm)		Type/ Order code	Pkg/ No. pcs
		W	W		
Ventilation filter - With IP54 230V~ fan					
10/8	23/30	105	105	EN1105K	1/1
20/19	57/61	150	150	EN1150K	1/1
17/15	120/135	204	204	EN1204K	1/1
29/29	240/270	250	250	EN1250K	1/1
67/87	520/580	325	325	EN2325K	1/1
Ventilation filter - With IP 54 1150V~ fan					
9/7	23/30	105	105	EN2105K	1/1
20/18	57/61	150	150	EN2150K	1/1
17/15	120/135	200	200	EN2204K	1/1
30/30	240/270	250	250	EN2250K	1/1
50/64	520/580	325	325	EN3325K	1/1

Special painting service

The customized painting service is available presenting a request of feasibility to our special product department (offer). See page 6/26 for all the available colors, other variants can be taken into consideration.

Special drilling service

The extra cost depends on the number of individual parts drilled rather than the number of holes made. Include the layout drawing of the holes to be drilled (see page 7/... for possible drilling areas).

Description	Type/ Order code	Pkg/ No. pcs
Extra cost for special drilling SRX	FORSRX	1/1
Extra cost for special drilling AMX	FORAMX	1/1
Extra cost for special drilling ISX	FORISX	1/1

Chapter 6

In-depth technical information

Structures

6-2 Conformity to standards

6-3 Resistance to mechanical impact

6-4 Degrees of protection

6-6 NEMA Classification

6-7 ATEX certification

6-8 Handling

6-10 Maximum capacities

6-14 Handling

6-16 Maximum capacities

Busbars with shaped section and flat busbars

6-19 Mechanical and electrical characteristics

6-24 Example of use - currents up to 1600A

Ventilation and air conditioning

6-25 General characteristics and applications

6-28 Technical characteristics

In-depth technical information

Conformity to standards

Reference standards

- CEI 17-70 "Guide to application of low voltage enclosure standards"
- IEC 61439-1-2 "Low voltage switchgear and control assemblies (LV switchboards) - Part 1: Type-tested (TTA) and partially type-tested (PTTA) assemblies"
- IEC EN 60529 (IEC 529-1) "Degrees of protection provided by enclosures (IP Code)"
- IEC 62262 "Degrees of protection provided by enclosures for electrical equipment against external mechanical impacts (IK Code)"
- CEI 17-43 (IEC 60890) "A method of temperature-rise assessment by extrapolation for partially type-tested assemblies of low voltage switch gear and control gear (LV switchboards) not mass-produced"
- CEI 17-52 "Method of assessment of the short-circuit withstand of switchgear and control-gear assemblies not mass-produced (PTTA)"
- IEC EN 62208 "Empty enclosures for low voltage switchgear and controlgear assemblies. General requirements"
- IEC EN 60204-1 (IEC 60204-1) "Safety of machinery - Electrical equipment of machines. Part 1: General requirements"
- IEC 60068-2-57 "Environmental testing Part 2: Tests method. Vibration - Time history method"
- IEEE Std 693 "Recommended Practice for Seismic Design of Substation" larity of 185 mm.

Laws which have implications for electrical enclosures

The new series of cabinets comply with national laws governing responsibilities concerning electrical apparatus and assemblies.

- Law 187/68, which states: Art.1. All of the materials, apparatuses, machinery, assemblies and electrical and electronic plants must be professionally produced and built. Art.2. The materials, apparatuses, machinery, assemblies and electrical plants produced in accordance with Italian Electrotechnical Committee standards are considered to be professionally built.
- The 2006/95/EC Low Voltage Directive (which substitutes 73/23/EEC and subsequent amendments) and indicates what safety characteristics electrical material marketed must have. In this case, the technical references are the Harmonised European Standards. In their absence, IEC publications and, next in order, National Standards.
- Legislative Decree No. 626 of 25 November 1996, implementing EEC Directive 93/68 concerning CE marking for the Low Voltage Directive, amended with Legislative Decree No. 227 of 31 July 1997.
- Law 46/90 and implementing order for Presidential Decree No. 447 of 6 December 1991; these introduce the obligation for the fitter to issue the client with a declaration of conformity with the Law concerning the plant and to which a report stating the type of components used must be attached.
- Directive 1999/92/EC and Directive 94/9/E Minimum requirements for improving health and safety protection of workers operating in potentially explosive atmospheres

In-depth technical information

Degree of protection against external mechanical impact - IK rating

SRX enclosures - AMX enclosures - ISX cabinets

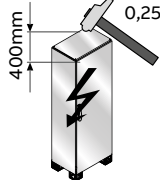
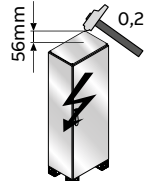
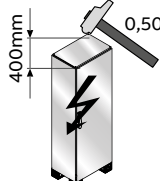
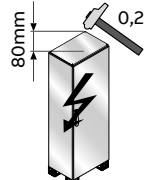
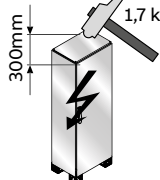
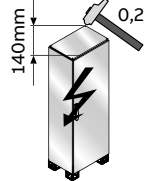
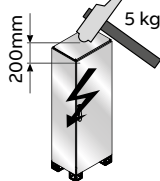
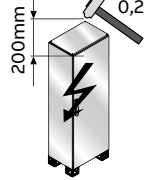
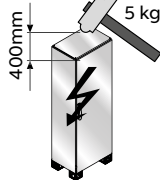
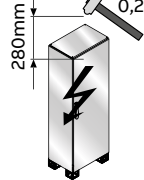
<p>IK 0 Not protected</p> 	<p>IK 06 Impact energy in Joule 1.00 J</p> 
<p>IK 01 Impact energy in Joule 0.150 J</p> 	<p>IK 07 Impact energy in Joule 2.00 J</p> 
<p>IK 02 Impact energy in Joule 0.200 J</p> 	<p>IK 08 Impact energy in Joule 5.00 J</p> 
<p>IK 03 Impact energy in Joule 0.350 J</p> 	<p>IK 09 Impact energy in Joule 10.00 J</p> 
<p>IK 04 Impact energy in Joule 0.500 J</p> 	<p>IK 10 Impact energy in Joule 20.00 J</p> 
<p>IK 05 Impact energy in Joule 0.700 J</p> 	

Tests carried out in accordance with IEC EN 62262.











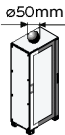
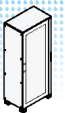
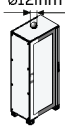

Degrees of protection of enclosures for electrical apparatus against external mechanical impact (IK Code).

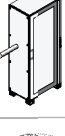
	With opaque door	With glass door
SRX enclosures	IK10	IK09
AMX enclosures	IK10	IK09
ISX cabinets with opaque/glass door	IK10	IK09

In-depth technical information

Degree of protection IP

SRX enclosures - AMX enclosures - ISX cabinets

1 st DIGIT: protection against solid objects		2 nd DIGIT: Protection against liquids	
0	No protection	0	No protection
1	 Protected against solid objects larger 50mm (accidental contact with the hands)	1	 Protected against vertically dripping water (condensation)
2	 Protected against solid objects larger than 12mm (fingers)	2	 Protected against water dripping at an angle up to 15° from the vertical
3	 Protected against solid objects larger than 2.5mm (tools, wires)	3	 Protected against rain falling at an angle up to 60° from the vertical
4	 Protected against solid objects larger than 1mm	4	 Protected against water splashing from all directions
5	 Protected against dust (no harmful deposits)	5	 Protected against jets of water sprayed from all directions
6	 Totally protected against dust	6	 Protected against jets of water similar to waves
		7	 Protected against the effects of temporary immersion
		8	 Protected against the effects of continuous immersion

Tests carried out in accordance with IEC EN 60529. Degree of protection of the enclosures (IP Code).

	With door
SRX enclosures blind/glazed door	IP66
AMX enclosures blind/glazed single door	IP66
AMX enclosures blind/glazed door, double door	IP66
ISX cabinets with opaque/glass door	IP65

In-depth technical information

Degree of protection IP

Protection against ingress of solid objects

1 st characteristic digit	Brief description	Full description
0	Not protected	No particular protection is envisaged
1	Protected against solid objects larger than 50mm	A large area of the human body, for example a hand (however, voluntary protection is not envisaged) or solid objects larger than 50mm in diameter must not be able to penetrate
2	Protected against solid objects measuring	The fingers or similar objects measuring 80mm or solid objects more than 12mm in diameter must not be able to penetrate
3	Protected against solid objects measuring more than 2.5mm	Tools, wires, etc., more than 2.5mm in diameter or thickness or solid objects more than 2.5mm in diameter must not be able to penetrate
4	Protected against solid objects measuring more than 1.0mm	Wires or flat cables more than 1.0mm thick or solid objects more than 1.0mm in diameter must not be able to penetrate
5	Protected against dust	Penetration of dust is not totally excluded but the quantity that may penetrate is not sufficient to impair the correct operation of the material
6	Totally protected against dust	No dust penetration is permitted

Protection against ingress of water

2 nd characteristic digit	Brief description	Full description
0	Not protected	No particular protection is envisaged
1	Protected against dripping water	Drops of water falling vertically must not produce harmful effects
2	Protected against water dripping at a maximum angle of 15°	Drops of water falling vertically must not produce harmful effects when the enclosure is tilted at any angle up to 15° from its normal position
3	Protected against rainfall	Water falling as a spray at any angle up to 60° from the vertical shall have no harmful effects
4	Protected against splashing water	Water splashing against the enclosure from any direction shall have no harmful effects
5	Protected against water jets	Water projected by a nozzle from any direction shall have no harmful effects
6	Protected against waves	Waves or powerful water jets shall not penetrate the enclosure in harmful quantities
7	Protected against the effects of temporary immersion	Ingress of water in harmful quantities shall not be possible when the enclosure is immersed in water under defined conditions of pressure and time
8	Protected against the effects of continuous immersion	The equipment is suitable for continuous immersion under conditions which shall be specified by the manufacturer

In-depth technical information

NEMA “National Electrical Manufacturers Association” Classification

SRX enclosures - AMX enclosures - ISX cabinets

Type	Description	Products classified
1	Enclosures constructed for indoor use to provide a degree of protection to personnel against incidental contact with the enclosed equipment and to provide a degree of protection against falling dirt.	Enclosures ISX - Enclosures AMX single door - Enclosures - AMX double door - SRX enclosures
2	Enclosures constructed for indoor use to provide a degree of protection to personnel against incidental contact with the enclosed equipment, to provide a degree of protection against falling dirt, and to provide a degree of protection against dripping and light splashing of non-corrosive liquids	
3	Enclosures constructed for either indoor or outdoor use to provide a degree of protection to personnel against incidental contact with the enclosed equipment; to provide a degree of protection against falling dirt, rain, sleet, snow, and windblown dust; and that will be undamaged by the external formation of ice on the enclosure.	
3R	Enclosures constructed for either indoor or outdoor use to provide a degree of protection to personnel against incidental contact with the enclosed equipment; to provide a degree of protection against falling dirt, rain, sleet, and snow; and that will be undamaged by the external formation of ice on the enclosure.	Enclosures ISX - Enclosures AMX single door - SRX enclosures
3S	Enclosures constructed for either indoor or outdoor use to provide a degree of protection to personnel against incidental contact with the enclosed equipment; to provide a degree of protection against falling dirt, rain, sleet, snow, and windblown dust; and in which the external mechanism(s) remain operable when ice laden.	
4	Enclosures constructed for either indoor or outdoor use to provide a degree of protection to personnel against incidental contact with the enclosed equipment; to provide a degree of protection against falling dirt, rain, sleet, snow, windblown dust, splashing water, and hose-directed water; and that will be undamaged by the external formation of ice on the enclosure.	Enclosures AMX single door - SRX enclosures
4x	Enclosures constructed for either indoor or outdoor use to provide a degree of protection to personnel against incidental contact with the enclosed equipment; to provide a degree of protection against falling dirt, rain, sleet, snow, windblown dust, splashing water, hose directed water, and corrosion; and that will be undamaged by the external formation of ice on the enclosure.	SRX enclosures - AMX enclosures single door
5	Enclosures constructed for indoor use to provide a degree of protection to personnel against incidental contact with the enclosed equipment; to provide a degree of protection against falling dirt; against settling airborne dust, lint, fibers, and flyings; and to provide a degree of protection against dripping and light splashing of non-corrosive liquids.	
6	Enclosures constructed for either indoor or outdoor use to provide a degree of protection to personnel against incidental contact with the enclosed equipment; to provide a degree of protection against falling dirt, rain, sleet, snow, hose-directed water, and the entry of water during occasional temporary submersion at a limited depth, and that will be undamaged by the external formation of ice on the enclosure	
6P	Enclosures constructed for either indoor or outdoor use to provide a degree of protection to personnel against incidental contact with the enclosed equipment; to provide a degree of protection against falling dirt, rain, sleet, snow, hose-directed water, corrosion and the entry of water during prolonged submersion at a limited depth; and that will be undamaged by the external formation of ice on the enclosure.	
12	Enclosures constructed (without knockouts) for indoor use to provide a degree of protection to personnel against incidental contact with the enclosed equipment; to provide a degree of protection against falling dirt, against circulating dust, lint, fibers, and flyings; against dripping and light splashing of non-corrosive liquids; and against light splashing and consequent seepage of oil and non-corrosive coolants.	Enclosures ISX - Enclosures AMX single door - SRX enclosures
12K	Enclosures constructed (with knockouts) for indoor use to provide a degree of protection to personnel against incidental contact with the enclosed equipment; to provide a degree of protection against falling dirt, against circulating dust, lint, fibers, and flyings; against dripping and light splashing of non-corrosive liquids; and against light splashing and consequent seepage of oil and non-corrosive coolants.	
13	Enclosures constructed for indoor use to provide a degree of protection to personnel against incidental contact with the enclosed equipment; to provide a degree of protection against falling dirt, against circulating dust, lint, fibers, and flyings; and against the spraying, splashing, and seepage of water, oil, and non-corrosive coolants.	

In-depth technical information

ATEX certification

TABLE 1 - GROUPS, CATEGORIES AND LEVELS OF PROTECTION

(source: Atex Guide - first edition - European Commission DG Enterprises, May 2000)

Level of protection	Group I	Group II	Performance of protection	Conditions of operation*
Very high	M1		Two independent means of protection or safety guaranteed even when two faults occur independently of each other	Equipment remains energised and functioning when explosive atmosphere present
Very high		1	Two independent means of protection or safety guaranteed even when two faults occur independently of each other	Equipment remains energised and functioning in Zones 0, 1, 2 (G) and/or 20, 21, 22 (D)
High	M2		Protection suitable for normal operation and severe operating conditions (37)	Equipment de-energised when explosive atmosphere is recognised
High		2	Protection suitable for normal operation and frequently occurring disturbances or equipment where faults are normally taken into account	Equipment remains energised and functioning in Zones 1, 2 (G) and/or 21, 22 (D)
SRX enclosures - AMX enclosures - ISX cabinets				
Normal		3	Protection suitable for normal operation	Equipment remains energised and functioning in Zones 2 (G) and/or 22 (D)

* Note: see also Directive 1999/92/EC on minimum requirements for improving health and safety protection of workers operating in potentially explosive atmospheres(38).

(37) Although the wording of the requirements of apparatuses belonging to categories M2 and 2 is different in the relative annexes to Directive 94/9/EC, both categories are treated in parallel by EN 50014 and specific standards. The concepts of technical protection relative to electrical apparatuses belonging to categories M2 and 2G (gas) in conformity with EN 50014 are identical. The requirements relative to category 2D (dusts) may, on the other hand, need to be considered separately.

(38) Official Journal L23, dated 28.1.2000.

TABLE 2 - Characteristics and zones corresponding to equipment in group II

(source: "Guide to certification - Directive 94/9/EC - Atex - concerning products intended to be used in potentially explosive atmospheres" - Ipsesl)

MANUFACTURER		USER																										
DPR 126/98 - Directive 94/9/EC Additional requirements for equipment including the devices and components connected with it)		D.Lgs. 233/03 Directive 1999/92/EC)																										
Group	Category	Means of protection			Presence of explosive atmosphere	Zone of use																						
		Level	Protection characteristics (Annex I)	Construction characteristics (Annex II)			Safety req. applicable																					
I	1	Very high	If a protective device develops a fault, the level of safety is guaranteed by at least a second, independent protective device. Moreover, the level of safety is also guaranteed if two faults occur independently of each other.	Must be designed and made so that the ignition sources are not activated, even in the event of equipment exceptional faults	1.0 1.1 1.2 1.3 1.4 1.5 1.6 2.1	Continuous or for long periods	0 1 2 20 21 22																					
				2	High			The level of safety is guaranteed even in the presence of recurring faults or equipment operating defects which must usually be taken into account	Must be designed and made to avoid ignition sources, even in the presence of recurring faults or equipment operating defects which must usually be taken into account	1.0 1.1 1.2 1.3 1.4 1.5 1.6 2.2																		
											II				Intermediate situation between the previous and the next	21 22												
																	3				Unlikely and if it occurs it is of short duration	2 22						
																							SRX enclosures - AMX enclosures - ISX cabinets					

In-depth technical information

Mechanical characteristics

Material

	Structure	Kit panels	Structure panels	Doors		Plates
	Stainless steel sheet AISI 304 [mm]	Stainless steel sheet AISI 304 [mm]	Stainless steel sheet AISI 304 [mm]	Stainless steel sheet AISI 304 [mm]	Safety glass external thickness [mm]	Galvanized Steel sheet [mm]
SRX Enclosures	12/10	12/10	-	12/10	4	20/10
AMX cabinets	15/10	12/10	-	15/10	4	25/10
ISX Enclosures	15/10	12/10	15/10	15/10	4	25/10

ISX cabinet vibration tests

The results of the vibration tests which our standard ISX automation enclosures have undergone are significant, above all when the enclosures are installed on ships, in seismic areas and in military areas. The vibration tests on the standard ISX enclosures have produced the following positive result: with respect to a stress 0.1 g in a range of frequencies between 10 and 500Hz, the maximum acceleration found inside the panel board is less than 0.5 g.

Range of frequency	10-500Hz
Stress	0,1 g
Maximum acceleration reached (inside the enclosure)	<0,5 g

We have also verified that the IS2 standard enclosure has linear behaviour even when the level of acceleration is increased up to 1 g in the same range of frequencies.

Antiseismic tests enclosures ISX

Enclosure ISX dimensions 2000x800x800mm (HXDXW) with 435 kh of load. Enclosures have been tested according with the Standard IEC 60068-2-57 "Environmental testing Part. 2: Tests method. Vibration - Time history method" and with the Standard IEEE Std 693 "Recommended Practice for Seismic Design of Substation".

Similar application fields*

Enclosure without specific accessories

According to the Standard IEC 60068-2-57 - IEEE Std 693	Seismic Zone IEC 68-3-3	Magnitudo Richter scale
Shock Level test up to 0.5 g	Zona 4	7

Enclosure with specific accessories AS0001+crosspieces+reinforced plinth

According to the Standard IEC 60068-2-57 - IEEE Std 693	Seismic Zone IEC 68-3-3	Magnitudo Richter scale
Shock Level test up to 0.75 g	Zona 4	7.5

* Values of different scales are indicative.

In-depth technical information

ABB SACE declaration of conformity

Conformity with the EN 62208, EN 61439-1 and 2 standards

The enclosures have undergone the type tests foreseen by the EN 62208 and EN 61439-1 and 2 standards at the ABB laboratories. The results of these tests guarantee the performances of the IS2 enclosures and allow the end panel board builder not to carry out any further type tests by respecting the selection criteria and assembly instructions of the various components. These results, given below, can be referred to for making out the declaration of conformity for the electric panel board.

CEI EN 62208 Standard

“Empty enclosures for low voltage switchgear and controlgear assemblies”.

EN 60439-1 and new 61439-1 and 2 standards

“Low voltage protection switchgear and controlgear assemblies”.

ISX Enclosures

Rated characteristics:

Rated service voltage Un	fino a 1000V AC - 1500V DC
Rated insulation voltage Ui	fino a 1000V AC - 1500V DC
Rated impulse withstand voltage Uimp	8 kV
Rated frequency fn	50-60Hz
Degree of protection	IP65
Mechanical impact strength IK	10 with blind door 09 with glazed door - 08 EMC version glazed door
Rated short-time current Icw	65 kA
Rated max.peak current Ipk	143 kA
Installation condition	Indoor/Outdoor

Efficiency of the protection circuit (Ref. par. 8.2.4. of the Standard)

By respecting the assembly indications for the metal components, the effective electrical continuity between the conductive electrical parts has been verified, with negligible resistance values.

Insulation distances (Ref. par. 8.2.5. of the Standard)

The insulation distances are guaranteed by following the ABB SACE metalwork structure and circuit-breaker assembly and mounting instruction. Mechanical operation (Ref. par. 8.2.6. of the Standard)

perazioni meccaniche (Rif. par. 8.2.6. della Norma)

By respecting the assembly instructions for the structures and ABB SACE circuit-breakers, mechanical operation is verified.

		Casse SRX	Armadi AMX
Rated service voltage Un		up to 1000V AC - 1500V DC	up to 1000V AC - 1500V DC
Rated insulation voltage Ui		up to 1000V AC - 1500V DC	up to 1000V AC - 1500V DC
Rated frequency fn		50-60Hz	50-60Hz
IP Degree of protection	with door	IP65	IP65
Mechanical impact strength IK	with blind door	10	10
	with glazed door	09	09

When correctly selected and assembled, as per the indications given in the catalogue and in the instruction manual, they allow of electrical panel boards complying with the EN 61439-1 and 2 Standard “Low voltage controlgear and switchgear for assemblies” and the CEI EN 60204-1 Standard “Safety of machinery – Electrical equipment of machines”, to be built, based on what is foreseen under the Low Voltage Directive of the European Community 2006/95/CE (which takes place of 73/23/CEE directive).

The above is valid if the electrical panel board is designed and constructed:

- selecting the materials based on the performances indicated in the ABB catalogues;
- sizing the conductors according to the prescriptions of the EN 61439-1 and 2 Standard, and Standard and CEI 64-8;
- carrying out the individual tests foreseen under the Standard EN 61439-1 and 2 Standard with a positive outcome.

In-depth technical information

Dissipating power

Temperature-rise (Ref. Standard EN 61439-1-2).

The following tables show the thermal dissipation values referred to all the dimensions of the enclosures and to the type of installation, coming from the type tests carried out. The dissipating power data (in Watts) depend on the admissible overtemperature inside the panel board in the upper Part, and must be compared with the sum of the powers dissipated by all the components installed inside the panel board.

Use of the dissipated power tables

The dissipated power value of a cabinet depends on the maximum temperature (T_{max}) and on the admissible overtemperatures (EN 61439-1-2 Standard).

Example

If an ambient temperature of 35 °C is considered, the value of dissipating power must be read in correspondence with the maximum admissible overtemperature (ΔT), which is 30 °C if a temperature at the top of the panel board of 65 °C is acceptable.

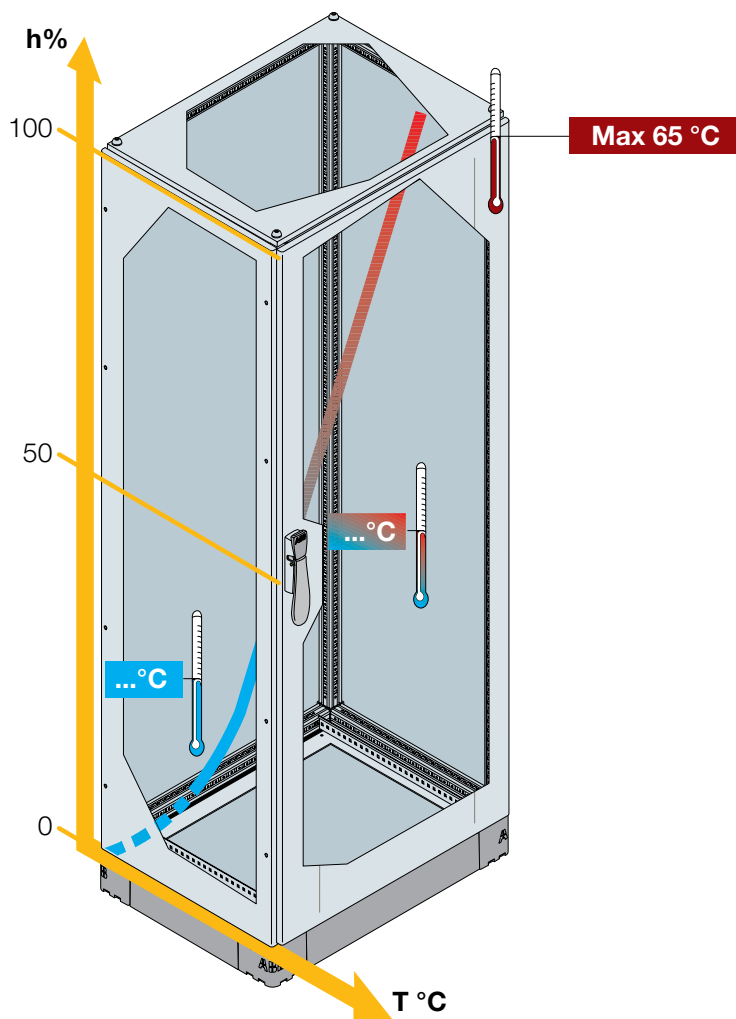

In-depth technical information

Dissipating power

SRX enclosures

Maximum dissipation power (W)

Dissipating power inside the SRX enclosures according to the permissible overtemperature (external temperature plus overtemperature = 60 °C max).

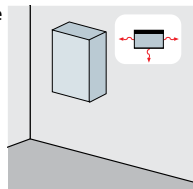

Wall-mounted single enclosure

Type	Dimensions			Overtemperature values ΔT			
	H (mm)	W (mm)	D (mm)	25 °C	30 °C	35 °C	40 °C
SRN3215X	300	200	150	29	35	42	50
SRN3415X	300	400	150	55	68	82	97
SRN4315X	400	300	150	48	60	72	85
SRN4320X	400	300	200	53	68	82	97
SRN4420X	400	400	200	68	84	101	119
SRN4620X	400	600	200	95	119	143	169
SRN5420X	500	400	200	76	95	116	137
SRN5420VX	500	400	200	76	95	116	137
SRN5520X	500	500	200				
SRN6420X	600	400	200	87	108	132	154
SRN6420VX	600	400	200	87	108	132	154
SRN6620X	600	600	200				
SRN6630X	600	600	300				
SRN7525X	700	500	250	119	150	182	214
SRN7525VX	700	500	250	119	150	182	214
SRN8620X	800	600	200				
SRN8625VX	800	600	250	151	190	230	272
SRN8630X	800	600	300	172	216	261	307
SRN8830X	800	800	300	183	228	278	328
SRN10830X	1000	800	300	228	286	346	409
SRN10830VX	1000	800	300	228	286	346	409
SRN12630X	1200	600	300	198	249	301	354
SRN12830X	1200	800	300	270	338	410	483

AMX enclosures

Maximum dissipation power (W)

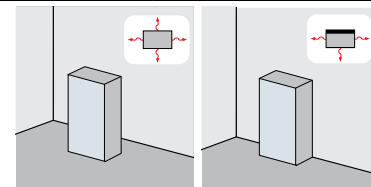

Single enclosure exposed on all sides

Wall-mounted single enclosure

Type	Dimensions			Overtemperature values ΔT							
	H (mm)	W (mm)	D (mm)	25 °C	30 °C	35 °C	40 °C	25 °C	30 °C	35 °C	40 °C
TM2664X	1600	600	400	417	523	634	748	376	471	571	676
TM2684X	1600	800	400	457	574	695	820	407	510	618	729
TM2864X	1800	600	400	373	468	568	669	317	397	483	569
TM2864VX	1800	600	400	373	468	568	669	317	397	483	569
TM2865X	1800	600	500	412	516	626	740	375	471	571	674
TM2865VX	1800	600	500	412	516	626	740	375	471	571	674
TM2884X	1800	800	400	471	592	717	846	402	505	611	722
TM2884VX	1800	800	400	471	592	717	846	402	505	611	722
TM2885X	1800	800	500	520	653	791	933	468	587	713	841
TM2885VX	1800	800	500	520	653	791	933	468	587	713	841
TM2804X	1800	1000	400	557	700	846	999	489	615	745	878
TM2805VX	1800	1000	500	635	798	967	1141	568	713	864	1020
TM2824X	1800	1200	400	648	814	986	1163	582	730	885	1046
TM2825X	1800	1200	500	705	883	1070	1264	668	837	1013	1197
TM2964X	2000	600	400	418	526	637	751	343	430	520	615
TM2965X	2000	600	500	442	557	674	795	404	507	613	724
TM2965VX	2000	600	500	442	557	674	795	404	507	613	724
TM2984X	2000	800	400	491	616	745	880	433	544	658	777
TM2985X	2000	800	500	561	705	854	1009	504	631	764	902
TM2985VX	2000	800	500	561	705	854	1009	504	631	764	902
TM2904X	2000	1000	400	598	751	911	1075	526	660	800	944
TM2905VX	2000	1000	500	650	816	988	1166	608	763	923	1091
TM2924X	2000	1200	400	666	835	1010	1194	623	782	948	1118
TM2925X	2000	1200	500	730	915	1110	1309	687	862	1044	1232

In-depth technical information

Dissipating power

ISX cabinets - H=1800mm

Maximum dissipation power (W)

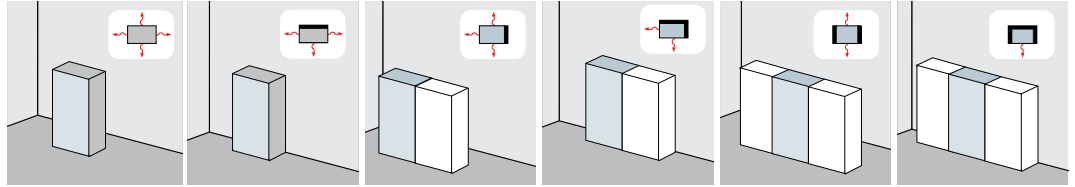

Type	Dimensions			Overtemperature values ΔT																							
	H (mm)	W (mm)	D (mm)	Single enclosure exposed on all sides				Wall-mounted single enclosure				First or last enclosure exposed				Wall-mounted first or last enclosure				Central enclosure exposed				Wall-mounted central enclosure			
				25 °C	30 °C	35 °C	40 °C	25 °C	30 °C	35 °C	40 °C	25 °C	30 °C	35 °C	40 °C	25 °C	30 °C	35 °C	40 °C	25 °C	30 °C	35 °C	40 °C	25 °C	30 °C	35 °C	40 °C
ES1864X	1800	600	400	352	442	536	632	317	397	483	569	328	412	499	589	293	368	446	526	302	378	458	542	272	341	413	489
ES1864VX	1800	600	400	352	442	536	632	317	397	483	569	328	412	499	589	293	368	446	526	302	378	458	542	272	341	413	489
ES1865X	1800	600	500	412	516	626	740	375	471	571	674	380	476	578	680	344	431	523	616	344	431	523	616	315	396	479	565
ES1865VX	1800	600	500	412	516	626	740	375	471	571	674	380	476	578	680	344	431	523	616	344	431	523	616	315	396	479	565
ES1884X	1800	800	400	455	571	692	817	402	505	611	722	431	541	655	774	380	476	576	680	402	505	611	722	360	452	547	647
ES1884VX	1800	800	400	455	571	692	817	402	505	611	722	431	541	655	774	380	476	576	680	402	505	611	722	360	452	547	647
ES1885X	1800	800	500	520	653	791	933	468	587	713	841	487	613	742	875	436	545	661	780	452	566	687	811	410	515	624	737
ES1885VX	1800	800	500	520	653	791	933	468	587	713	841	487	613	742	875	436	545	661	780	452	566	687	811	410	515	624	737
ES1805X	1800	1000	500	635	798	967	1141	568	713	864	1020	600	753	912	1076	536	671	814	960	568	713	864	1020	513	643	779	920
ES1805VX	1800	1000	500	635	798	967	1141	568	713	864	1020	600	753	912	1076	536	671	814	960	568	713	864	1020	513	643	779	920
ES1806X	1800	1000	600	684	857	1039	1226	645	809	980	1157	663	832	1009	1190	603	756	915	1081	626	785	952	1124	571	717	869	1025
ES1806VX	1800	1000	600	684	857	1039	1226	645	809	980	1157	663	832	1009	1190	603	756	915	1081	626	785	952	1124	571	717	869	1025
ES1827BX	1800	1200	500	705	883	1070	1264	668	837	1013	1197	687	862	1046	1234	635	796	965	1139	680	853	1033	1219	615	772	935	1104
ES1826BX	1800	1200	600	705	883	1070	1264	668	837	1013	1197	687	862	1046	1234	635	796	965	1139	680	853	1033	1219	615	772	935	1104

In-depth technical information

Dissipating power

ISX cabinets - H=1800mm

Maximum dissipation power (W)

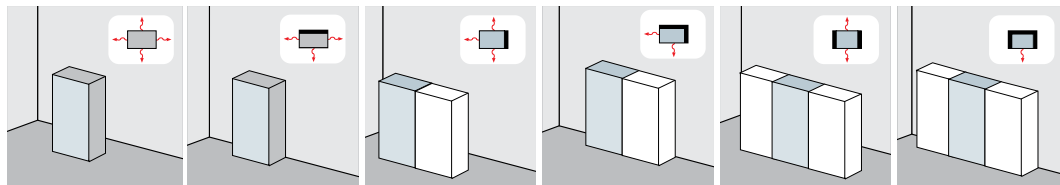

Type	Dimensions			Overtemperature values ΔT																							
	H (mm)	W (mm)	D (mm)	Single enclosure exposed on all sides				Wall-mounted single enclosure				First or last enclosure exposed				Wall-mounted first or last enclosure				Central enclosure exposed				Wall-mounted central enclosure			
				25 °C	30 °C	35 °C	40 °C	25 °C	30 °C	35 °C	40 °C	25 °C	30 °C	35 °C	40 °C	25 °C	30 °C	35 °C	40 °C	25 °C	30 °C	35 °C	40 °C	25 °C	30 °C	35 °C	40 °C
ES2065K	2000	600	500	442	557	674	795	404	507	613	724	407	512	619	730	368	462	560	661	368	463	560	661	336	423	423	605
ES2065VX	2000	600	500	442	557	674	795	404	507	613	724	407	512	619	730	368	462	560	661	368	463	560	661	336	423	423	605
ES2066K	2000	600	600	507	635	771	909	467	586	708	837	462	579	701	828	421	529	642	758	413	518	627	740	381	479	479	685
ES2066VX	2000	600	600	507	635	771	909	467	586	708	837	462	579	701	828	421	529	642	758	413	518	627	740	381	479	479	685
ES2085K	2000	800	500	561	705	854	1009	504	631	764	902	526	660	800	944	468	587	711	840	484	608	737	870	439	550	550	787
ES2085VX	2000	800	500	561	705	854	1009	504	631	764	902	526	660	800	944	468	587	711	840	484	608	737	870	439	550	550	787
ES2086K	2000	800	600	623	782	946	1116	576	722	875	1033	582	732	886	1046	529	664	804	951	537	676	817	965	494	619	619	885
ES2086VX	2000	800	600	623	782	946	1116	576	722	875	1033	582	732	886	1046	529	664	804	951	537	676	817	965	494	619	619	885
ES2007K	2000	1000	500	650	816	988	1166	608	763	923	1091	632	795	962	1136	571	717	869	1025	608	763	923	1091	547	685	685	981
ES2005VX	2000	1000	500																								
ES2006X	2000	1000	600	705	885	1071	1264	674	846	1025	1210	680	854	1034	1221	645	809	980	1157	664	835	1010	1194	611	766	928	1096
ES2006VX	2000	1000	600	705	885	1071	1264	674	846	1025	1210	680	854	1034	1221	645	809	980	1157	664	835	1010	1194	611	766	928	1096
ES2025BX	2000	1200	500	730	915	1110	1309	687	862	1044	1232	709	890	1078	1272	676	848	1028	1213	697	875	1060	1252	658	825	1001	1181
ES2026BX	2000	1200	600	793	994	1205	1422	743	933	1129	1334	763	957	1158	1367	726	911	1104	1301	743	933	1129	1334	726	911	1104	1303

In-depth technical information

Handling

Handling by means of transpallets

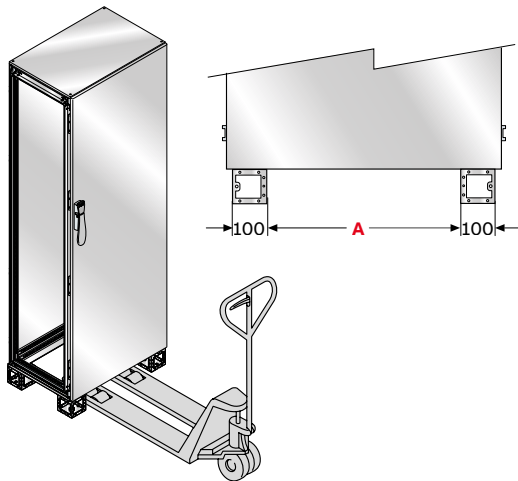

For greater safety during transport by means of a fork-lift truck, it is advisable to anchor the panel board to the fork-lift truck:

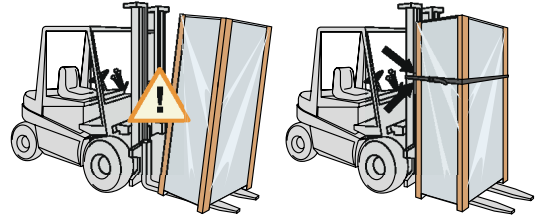

In the case of W=800mm structures (with internal or external cable container) containing a busbar system, check the centre of gravity before handling.

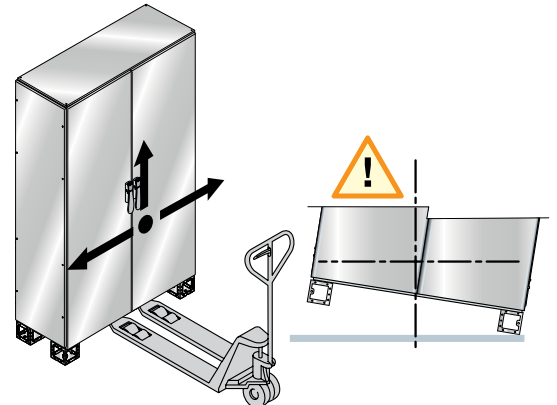

Plinth

	A (mm)
Structure W=600mm	393
Structure W=800mm	593
Structure W=1000mm	793
Structure W=1200mm	394 + 394

6

In-depth technical information

Handling

Handling by means of bridge crane

For handling by means of crane or bridge crane, check the following conditions before lifting the panel board:

- excellent state of the ropes or chains;
- the angle between the lifting ropes and the roof of the switchboard must be $\geq 45^\circ$;

- maximum number of columns which can be transported see pages 6/10-11;
- maximum weight which can be lifted see pages 6/10-11.

When there are several columns placed side by side, to respect the above-mentioned conditions, a lifting beam with appropriate characteristics can be used.

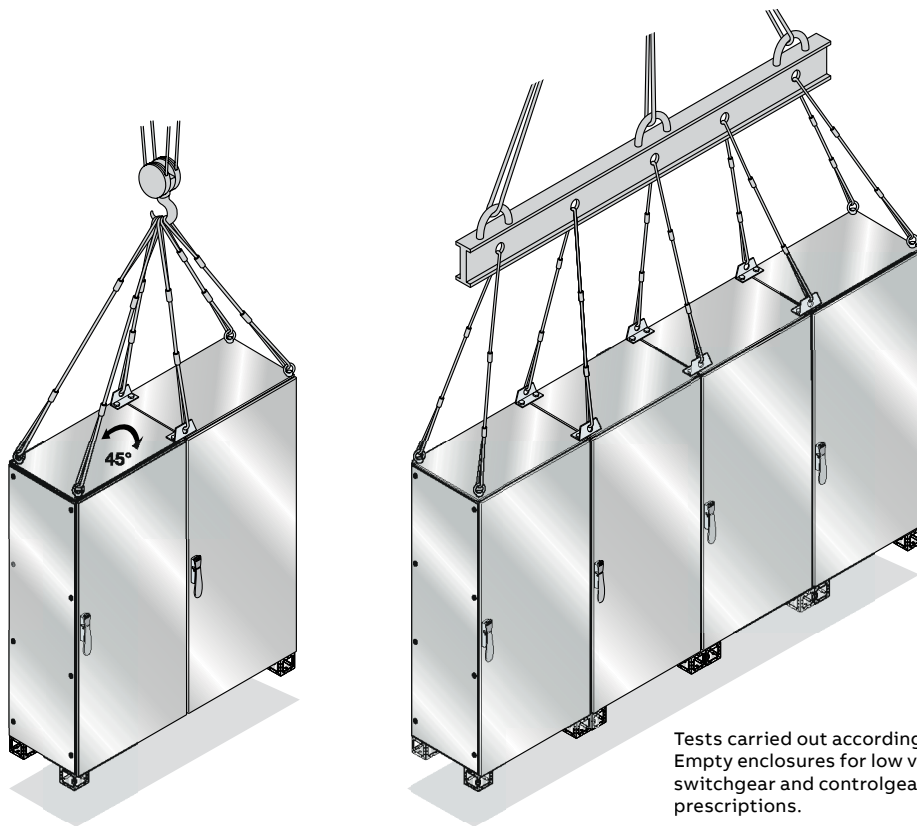

Tests carried out according to EN 62208 (par. 8.4) Empty enclosures for low voltage protection switchgear and controlgear assemblies. General prescriptions.

Standard DIN 580 concerning mechanical connection components (only for eyebolts)

Eyebolts

Lifting reinforcements

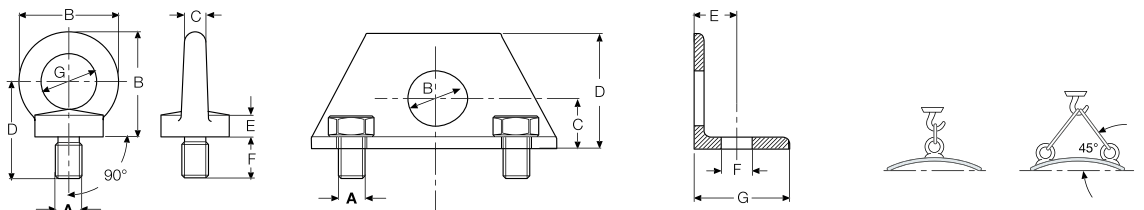

A	B (mm)	C (mm)	D (mm)	E (mm)	F (mm)	G (mm)	Load 1 (kg)	Load 2 (kg)	Tightening (Nm)
Eyebolts									
M12	54	12	28	10	22	30	340	240	8*
Lifting reinforcements									
M12	Ø40	37	80	25	Ø14	60	510	350	40

In-depth technical information

Maximum capacities

(in accordance with the CEI EN 62208 Standard)

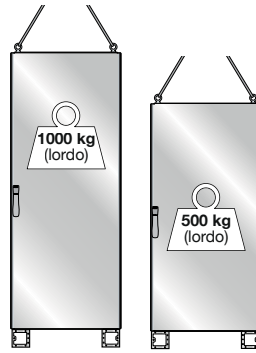

	ISX	AMX
Number of columns	1	1
Weight of single column Kg	1000	500
Total weight of columns Kg	1000	500
Joining Kit		
Lifting Kit	AA9610	TA9601
Number of braces used	4	4

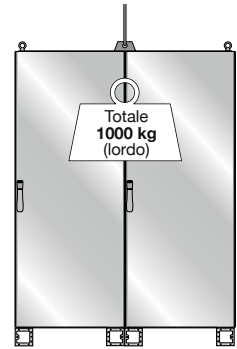

	ISX
Number of columns	2
Weight of single column Kg	500
Total weight of columns Kg	1000
Joining Kit	EV0002X EV0003X EV1007
Lifting Kit	
Number of braces used	2

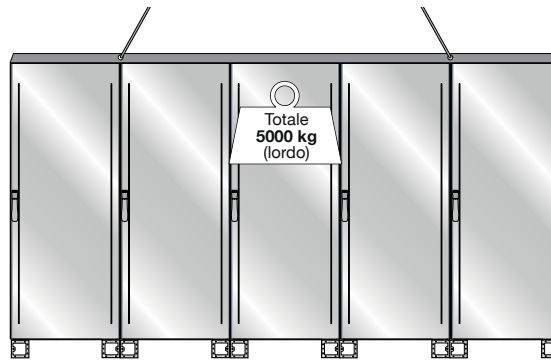

	ISX
Number of columns	5
Weight of single column Kg	1000
Total weight of columns Kg	5000
Joining Kit	EV0003X TU1000
Lifting Kit	4
Number of braces used	4

In-depth technical information

Maximum capacities

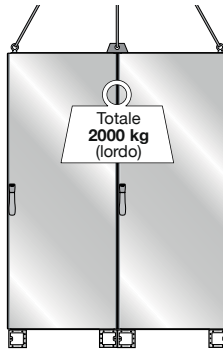

ISX	
Number of columns	2
Weight of single column Kg	1000
Total weight of columns Kg	2000
Joining Kit	EV0002X EV0003X
Lifting Kit	AA9610 EV1007
Number of braces used	6

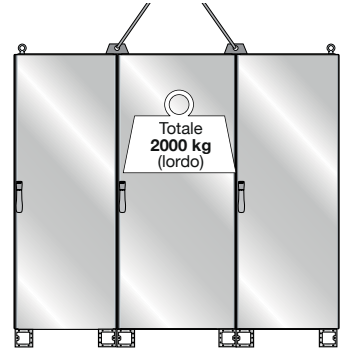

ISX	
Number of columns	3
Weight of single column Kg	500
Total weight of columns Kg	1500
Joining Kit	EV0002X EV0003X
Lifting Kit	EV1007
Number of braces used	6

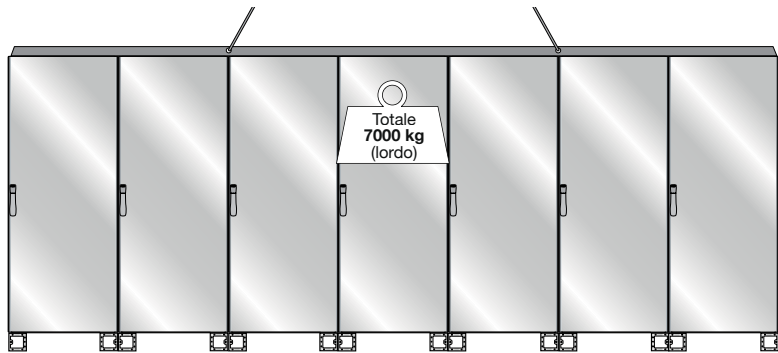

ISX	
Number of columns	7
Weight of single column Kg	1000
Total weight of columns Kg	7000
Joining Kit	EV0003X TU1000
Lifting Kit	4
Number of braces used	4

In-depth technical information

Maximum capacities

(in accordance with the CEI EN 62208 Standard)

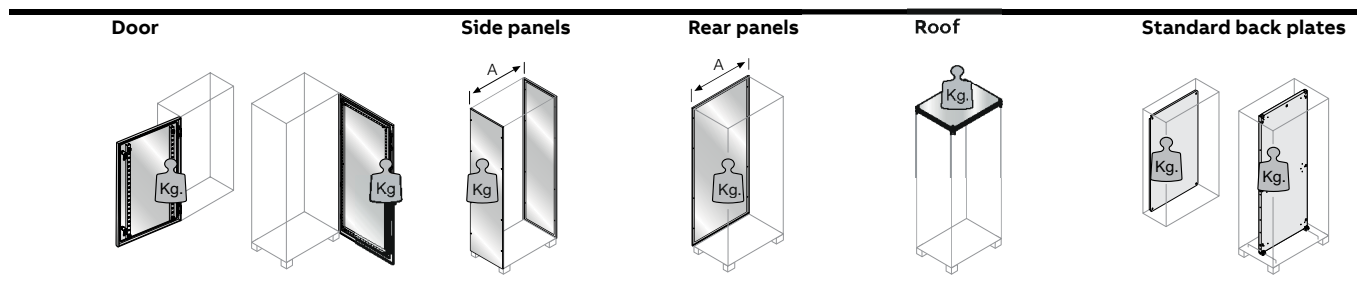

	Kg	A (mm)	Kg	A (mm)	Kg	Kg	Kg
SRX	20			> 800	90		50
AMX	50			≤ 800	110		180
ISX	50	> 800	90	> 800	90	40	500
		≤ 800	110	≤ 800	110		

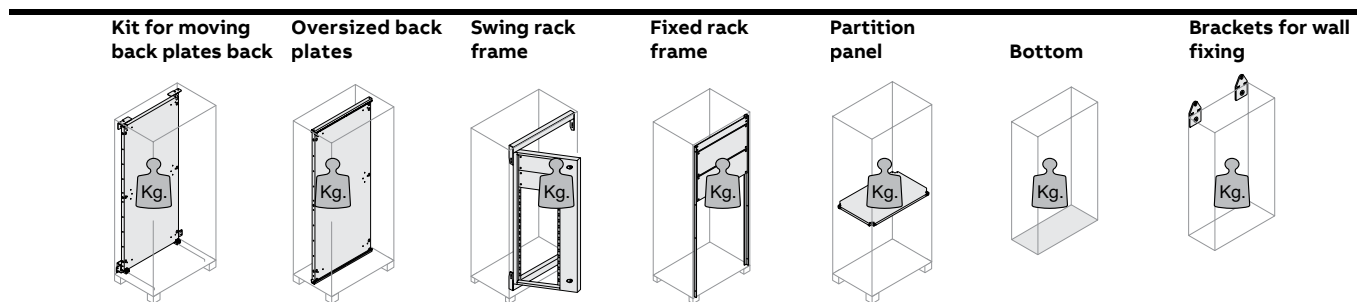

	Type	Kg	Kg	Kg	Kg	Kg	Kg	Type	Kg
SRX							100	AA1206X	200
AMX	EA5100	200			90	120			
ISX	EA2100	600	500	90	90	120			

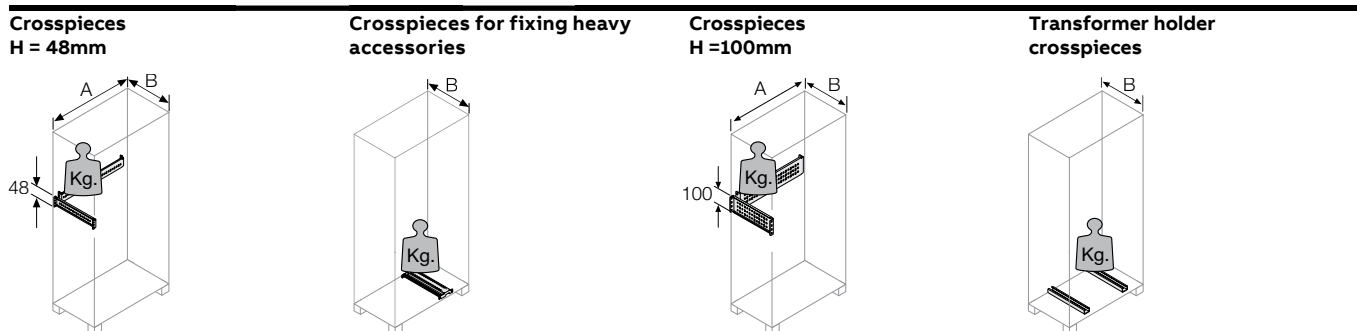

Type	A/B (mm)	Kg	Type	B (mm)	Kg	Type	A/B (mm)	Kg	Type	A/B (mm)	Kg
EB0400	400	110	EB4100	400	210	EB0440	400	220	EB6102	600	320
EB0500	500	110	EB5100	500	190	EB0550	500	210	EB8102	800	250
EB0600	600	100	EB6100	600	175	EB0660	600	210	EB1102	1000	200
EB0800	800	90	EB8100	800	150	EB0880	800	185			
EB1000	1000	70	EB1100	1200	130	EB1010	1000	160			
EB1200	1200	50				EB1020	1200	140			

In-depth technical information

Busbars with shaped section and flat busbars

Mechanical and electrical characteristics

Conformity with EN 61439-1-2 Standard

The ISX cabinets have undergone the type tests foreseen by the EN 61439-1-2 Standard in ABB laboratories.

The results of these tests guarantee the performances of the IS2 cabinets and, by using ABB SACE

metalwork structures and accessories, such as moulded-case and modular circuit-breakers, allow the end panel board builder not to carry out further type tests, as long as the selection criteria and assembly instructions of the various components are respected, just carrying out the individual tests foreseen by the EN 61439-1-2 Standard. It is possible to make reference to these results, given below, to draw up the declaration of conformity of the electrical panel board.





Characteristics of the materials

Components	Material
Busbars	electrolytic copper 99.9% CU-ETP
Busbar holder	self-extinguishing thermoplastic VO
Tightening screws	Material class 8.8
Tightening torque	M6 screws - 10N.m
	M8 screws - 20N.m
	M10 screws - 30N.m

In-depth technical information

Busbars with shaped section and flat busbars









Technical characteristics of busbars with shaped section up to 1600A

Cross-section	In (A)	Type	No. busbars/phase	Capacity			Dimensions		Lenght (mm)	Weight (kg)
				(A) IP66	Icw max (kA)	IpK (kA)	WxW (mm)	Cross-section (mm ²)		
	400	BA0400	1	400	35	74	20x20	200	1730	4
	800	BA0800	1	800	35	74	20x20	283	1730	4.4
	1250	BA1250	1	1250	65	143	20x60	603	1730	9.3
	1600	BA1600	1	1600	65	143	20x60	703	1730	10

In-depth technical information

Busbars with shaped section and flat busbars

Technical characteristics of flat busbars up to 1600A

Cross-section	In (A)	Type	No. busbars/ phase	Capacity (A) IP66	I _{cw} max (kA)	I _{pK} (kA)	Dimensions		
							WxW (mm)	Cross-section (mm ²)	Weight (kg)
	250	BR0250	1	250	32	48	15X5	1750	1.35
	400	BR0400	1	400	32	48	25X5	1750	3.4
	630	BR0630	1	630	32	68	30X10	1750	4.4
	400	BR4005	1	400	35	74	32X5	1750	2.1
	630	BR6305	1	630	50	105	50X5	1750	3.4
	800	BR8005	1	800	50	105	63X5	1750	4.4
	1250	BR1250	1	1250	50	105	100X5	1750	7.25
	1600	BR1600	1	1600	100	220	100X10	1750	14.5

In-depth technical information

Busbars with shaped section and flat busbars

Busbar holders for busbars with shaped section

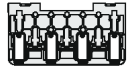
Tipo	Icc (kA)	Busbar holder	In (A)	Busbars with shaped section			
				400A	800A	1250A	1600A
	35	PB0803	L1-L2-L3	3xBA0400	3xBA0800	-	-
			N 100%	1xBA0400	1xBA0800	-	-
			N ridotto	-	1xBA0400	-	-
	65	PB1603 ⁽¹⁾	L1-L2-L3	-	-	3xBA1250	3xBA1600
			N 100%	-	-	1xBA1250	1xBA1600
			N ridotto	-	-	-	1xBA1250

Busbar	Capacity (A)	Busbar holder	No. and distance of the busbar holder according to the max I _{cc}							
			25 kA	X max (mm)	35 kA	X max (mm)	50 kA	X max (mm)	65 kA	X max (mm)
BA0400	400	PB0803	4	550	5	425	-	-	-	-
		PB1603 ⁽¹⁾	4	550	4	550	-	-	-	-
BA0800	800	PB0803	4	550	5	425	-	-	-	-
		PB1603 ⁽¹⁾	4	550	4	550	-	-	-	-
BA1250	1250	PB1603	4	550	4	550	6	350	9	225
BA1600	1600	PB1603	4	550	4	550	6	350	9	225

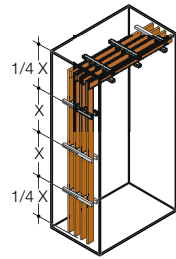

The distance between the first busbar holder and the end of the busbar must not exceed 1/4 of X.

X max = maximum distance not to be exceeded between two consecutive busbar holders.

⁽¹⁾ It is possible to mount the 400/800A busbars with the special adapter AD1066.

Busbar holder for flat busbars

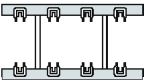
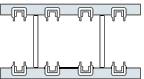
Tipo	Icc (kA)	Busbar holder	In (A)	Flat busbars					
				250A	400A	630A	800A	1250A	1600A
	32	BP0630	L1-L2-L3	3xBR0250	3xBR0400	3xBR0630	-	-	-
			N 100%	1xBR0250	1xBR0400	1xBR0630	-	-	-
	50	BP1250	L1-L2-L3	-	3xBR4005	3xBR6305	3xBR8005	3xBR1250	-
			N 100%	-	1xBR4005	1xBR6305	1xBR8005	1xBR1250	-
	75	BP1600	L1-L2-L3	-	-	-	-	-	3xBR1600
			N 100%	-	-	-	-	-	1xBR1600

Busbar	Capacity (A)	Busbar holder	No. and distance of the busbar holder according to the max I _{cc}							
			16 kA	X max (mm)	20 kA	X max (mm)	23 kA	X max (mm)	32 kA	X max (mm)
BR0250	250	BP0630	4	500	6	350	10	200	-	-
BR0400	400		4	500	6	350	10	200	-	-
BR0630	630		-	-	4	600	4	600	9	210
Busbar	Capacity (A)	Busbar holder	25 kA	X max (mm)	35 kA	X max (mm)	50 kA	X max (mm)	65 kA	X max (mm)
BR4005	400	BP1250	7	300	9	225	-	-	-	-
BR6305	630		6	375	7	275	9	225	-	-
BR8005	800		5	425	7	300	9	225	-	-
BR1250	1250		4	500	6	375	8	250	-	-
BR1250	1600	BP1600	3	1000	3	1000	4	600	6	375

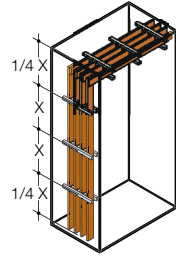

The distance between the first busbar holder and the end of the busbar must not exceed 1/4 of X.

X max = maximum distance not to be exceeded between two consecutive busbar holders.

In-depth technical information

Busbars with shaped section and flat busbars

01 Direct branch by means of cable terminal for cross-section of cable up to 50mm².

02 M8 self-locking hammer screw for fixing between conductors in any position along the busbar, guarantees a large contact surface.

03 The 25mm drilling pitch allows branches between flat busbars at any point.

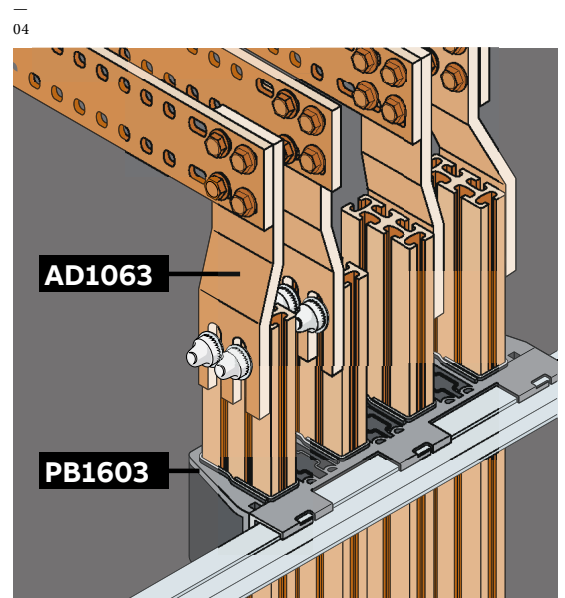
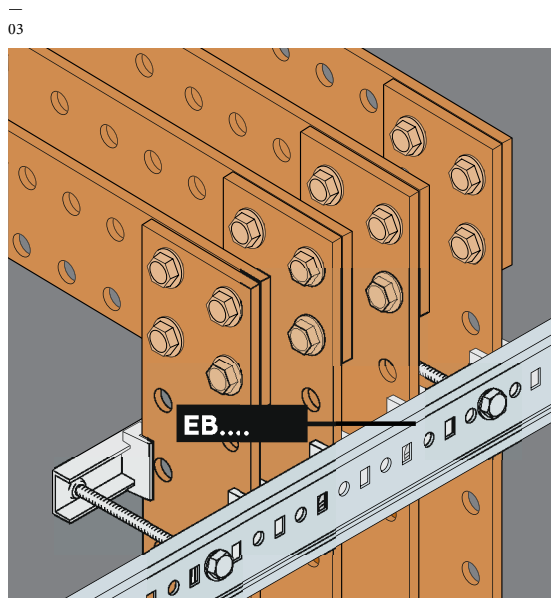
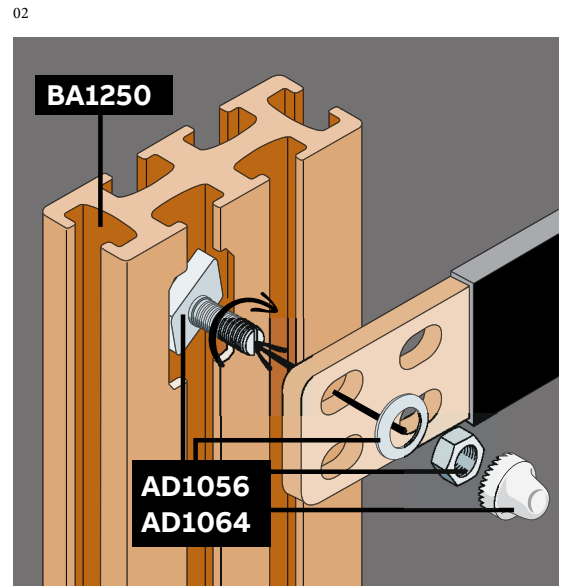
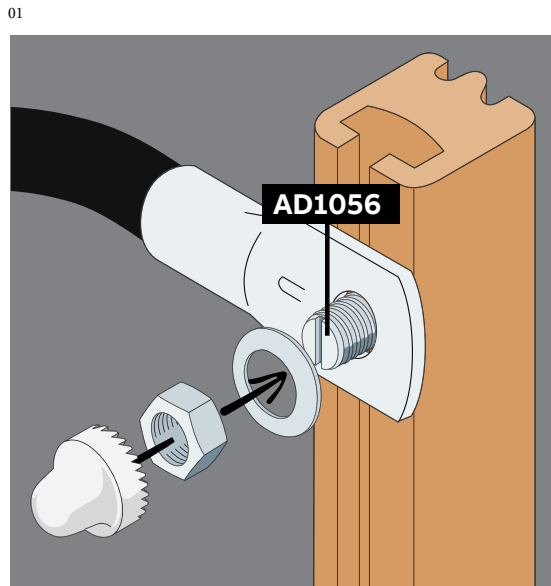

04 Branch between 1600A flat busbars and 1250/1600A busbars with shaped section.



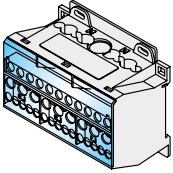

In-depth technical information

Busbars with shaped section and flat busbars

Modular dividers

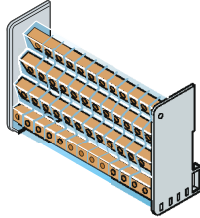
Four-poles	Code	AD1004	
	Mark	 CE	
	In	(A) 125	
	Icw	(kA) 10	
	Ipk	(kA) 24	
	Version	poles 4.2	
	Installation	DIN35/plate	
	Power supplye	min. 6	
	Ø cable (mm ²)	max 35	
	No.outgoing feeder (mm ²) Ø cable	With cable lugs	
		5L, 4Nx1,5-6mm ²	
		2L, 6Nx4-10mm ²	
		1L, 1Nx6-25mm ²	
		Without cable lugs	
	5L, 4Nx1,5-6mm ²		
	2L, 6Nx4-10mm ²		
1L, 1Nx6-35mm ²			
Dimensions (mm) HxWxD	74.5x98x45		
No. DIN modules	5,5		
Rated service voltage Ue (V)	1000 Vac/1500 Vdc		
Degree of protection IP	20		

Four-poles	Code	AD1028	
	Mark	 CE	
	In	(A) 125	
	Icw	(kA) 4.2	
	Ipk	(kA) 25	
	Version	poles 4	
	Installation	DIN35/plate	
	Power supplye	min. 6	
	Ø cable (mm ²)	max 25 with cable terminal	
	No.outgoing feeder (mm ²) Ø cable	Rigid cable	
		7x1,5-10mm ²	
		2x6-25mm ²	
		With cable lugs	
		7x1,5-10mm ²	
	2x6-16mm ²		
	Without cable lugs		
7x2,5-16mm ²			
2x6-35mm ²			
Dimensions (mm) HxWxD	93x89x48		
No. DIN modules	5		
Rated service voltage Ue (V)	440		
Degree of protection IP	20		

In-depth technical information

Busbars with shaped section and flat busbars

Modular dividers

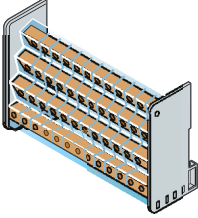
Four-poles		Code	AD1029
	Mark	CE	
		CE	
In	(A)	125	
Icw	(kA)	4.2	
Ipk	(kA)	25	
Version	poles	4	
Installation		DIN35/plate	
Power supplye	min.	6	
Ø cable (mm ²)	max	25 with cable terminal	
No.outgoing feeder		Rigid cable	
(mm ²) Ø cable		9x1,5-10mm ²	
		2x1,5-16mm ²	
		2x6-25mm ²	
		With cable lugs	
		2x1,5-6mm ²	
		9x1,5-10mm ²	
		2x6-16mm ²	
		Without cable lugs	
		11x2,5-16mm ²	
		2x6-35mm ²	
Dimensions	(mm)	96x126x48	
HxWxD			
No. DIN modules		7	
Rated service voltage Ue	(V)	440	
Degree of protection	IP	20	

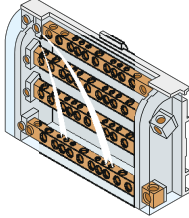
Four-poles		Code	AD1027
	Mark	CE	
		CE	
In	(A)	AD1027	
Icw	(kA)	160	
Ipk	(kA)	6.2	
Version	poles	20	
Installation		4	
Power supplye	min.	DIN35	
Ø cable (mm ²)	max	10	
No.outgoing feeder		50	
(mm ²) Ø cable		Rigid cable	
		8x2,25-25mm ²	
		1x10-50mm ²	
		3x16-35mm ²	
		With cable lugs	
		8x2,5-16mm ²	
		3x6-25mm ²	
		1x10-35mm ²	
		Without cable lugs	
		8x6-16mm ²	
		3x6-25mm ²	
		1x10-35mm ²	
Dimensions	(mm)	90x160.5x50	
HxWxD			
No. DIN modules		9	
Rated service voltage Ue	(V)	440	
Degree of protection	IP	20	

In-depth technical information

Busbars with shaped section and flat busbars

Examples of use - currents up to 1600A

Linear busbar holder PB1603

ISX

Busbars in the additional structure W=400mm and DIN rail apparatus holder fixed on the back plate.

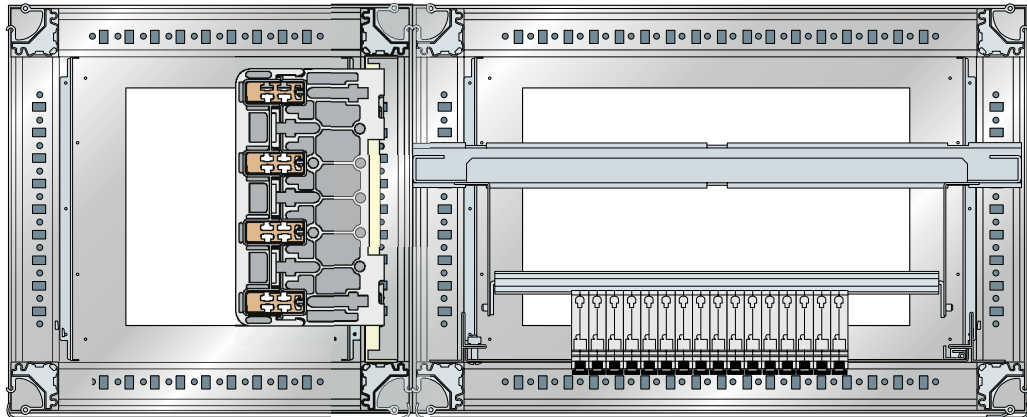

Linear busbar holder PB1603

ISX

Busbars in the additional structure W=400mm and kit for moulded-case apparatus fixed on the back plate.

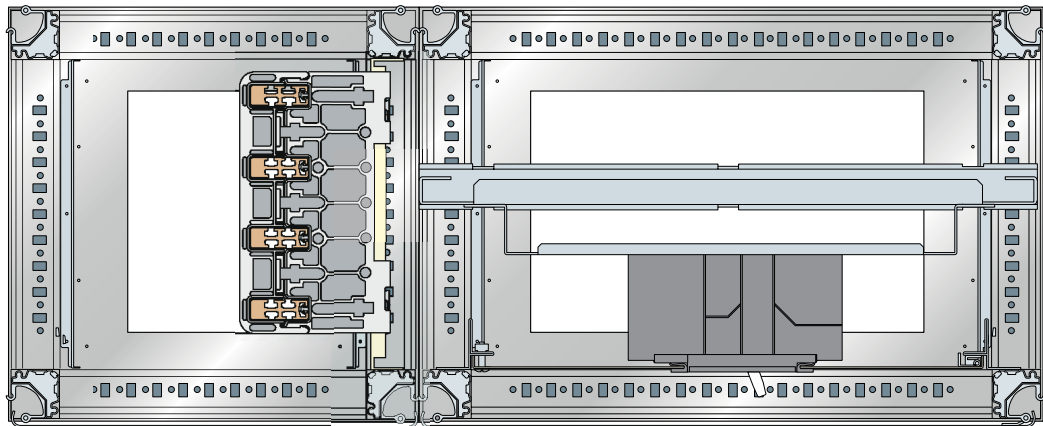

In-depth technical information

Ventilation and air conditioning

General characteristics and applications

Natural ventilation together with forced ventilation is used when the temperature inside the electrical panel board exceeds the ambient temperature. Fans are economical and efficient, making possible to keep degrees of protection up to IP54, in the case of use of a filter, or IP21 without the latter.

The only precaution needed is periodic cleaning of the filtering elements.

Natural ventilation

Panel board cooling can be obtained by means of simple natural convection. In fact, it is sufficient to the install aeration kit (in the different ways shown in the diagram) to obtain a fair improvement in panel board cooling.

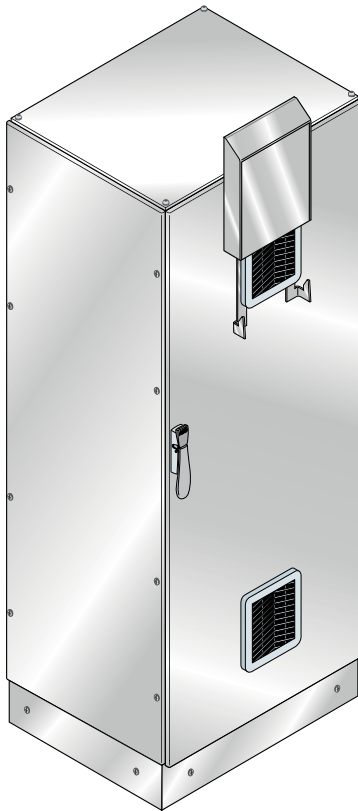

Natural aeration with gratings (IP54 with filter or IP21 without filter).

In-depth technical information

Ventilation and air conditioning

Operation and selection of components

Forced ventilation

Operation of the ventilation kit is simple: the ambient air - in this case colder than the air inside the panel board - is sucked up from below, filtered of impurities and conveyed inside. It grazes the apparatus cooling it, whilst the warmer air flows towards the upper part and exits through the special air passage. In this way a slight overpressure is created inside, which prevents dust from entering.

Even when the fan is not working, there is no formation of condensation and humidity, since the entry and exit fans are a guarantee of rapid heat exchange.

For correct operation, it is good practice to periodically clean the filtering part by shaking, compressed air or washing in water, or to replace it with a new cloth.

How to calculate the capacities of the fans

Once the value of the power to be dissipated has been calculated, given by the sum of the dissipating power of each device, and by the conductors (taking into account the contemporaneity coefficient as well) and once the maximum temperature inside the panel board has been defined - compatibly with correct operation of the apparatus it contains - the following formula must be applied:

$$Q = \frac{P}{\Delta T} \cdot f$$

where:

Q = fan capacity (m³/h)

P = power to be dissipated (W)

ΔT = difference in the ambient temperature Te and the temperature inside the panel board Ti

f = coefficient of thermal exchange

Ti > Te

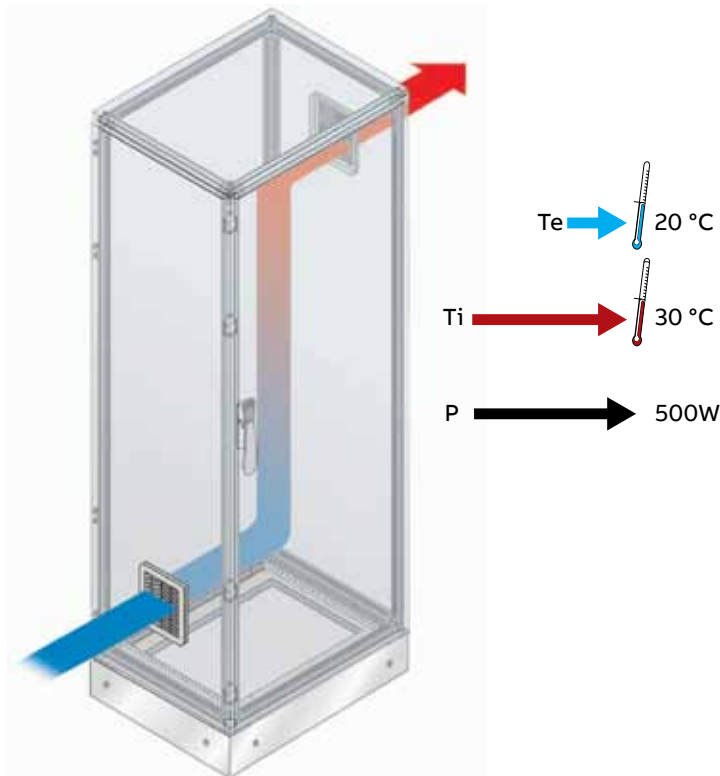

Height m/slm	f m ³ °C/Wh
0 ÷ 100	3.1
100 ÷ 250	3.2
250 ÷ 500	3.3
500 ÷ 700	3.4
750 ÷ 1000	3.5

example: $Q = \frac{500}{10} \cdot 3.2 = 160 \frac{\text{m}^3}{\text{h}}$

In-depth technical information

Ventilation and air conditioning

How to install the ventilation kit

Use of a ventilator as a means for extracting heat from a cabinet is recommended when an internal temperature higher than the ambient temperature is acceptable.

In both cases (A and B), to improve the thermal performances of the system, it is advisable to use the filter without a fan one size larger than the one with a fan.

The best thermal situations are obtained by installing the aeration kit in the following ways:

Ventilation kit at the top and filter at the bottom on the opposite wall - Fig.1

The fan sucks in hot air from the top area of the cabinet towards the outside, whilst fresh air enters through the filter placed at the bottom. This configuration is recommended for cabinets fitted with gaskets as it is the condition which offers better temperature distribution.

Ventilation kit at the bottom and filter at the top on the opposite wall - Fig.2

The fan sucks in fresh air from the outside towards the bottom area inside the cabinet, whilst hot air exits through the filter placed at the top. This solution is particularly recommended when you want to avoid entry of dust as far as possible, using the delivery fan, so as to put the cabinet under pressure and prevent entry of dust through the gaps between the panels. Entry of dust is prevented by the fan filter.

Hood with fan mounted on the cabinet roof and filter placed at the bottom on a wall - Fig.3

In this configuration, the air flow moves from the bottom towards the top: fresh air enters the cabinet through the filter placed at the bottom and hot air exits to the room through the hood. When the hood is used, what has already been said in the previous cases is valid with regard to selecting to mount the fan on delivery or on suction.

Air flow

Fig.1

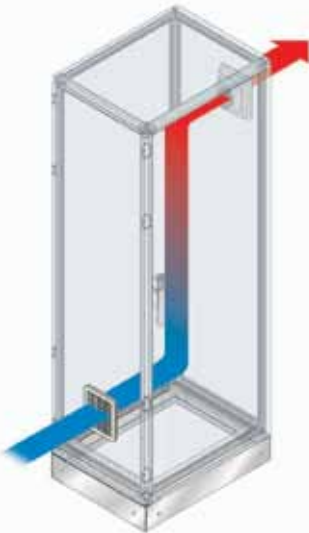

Fig.2



Fig.3



In-depth technical information

Ventilation and air conditioning

Technical characteristics



Fans

Characteristic	U.m.	EN1105K	EN2105K	EN1150K	EN2150K	EN1204K
Capacity air	m ³ /h	23/30	23/30	57/61	57/61	120/135
Standard power supply (single-phase)	V a.c.	230	115	230	115	230
Frequency	Hz	50/60	50/60	50/60	50/60	50/60
Total power consumption	W	10/8	9/7	20/19	20/19	17/15
Rated current	A	0.07/0.055	0.115/0.092	0.125/0.110	0.210/0.180	0.100/0.090
Rotation speed	rpm	2700	2700	2650	2650	2700
Noise	dB(A)	33/38	33/38	46/49	46/49	46/50
Operating temperature	°C	-10+50	-10+50	-10+50	-10+50	-10+50
Electrical life	h	45.000	45.000	45.000	45.000	45.000
Degree of protection	IP	54	54	54	54	54
Class		I	I	I	I	I
Weight	Kg	0,5	0,5	0,8	0,8	1,1
Protection		Impedance	Impedance	Impedance	Impedance	Impedance
Electric connection		Wires	Wires	2-pole term.	2-pole term.	3-pole term.
Mounting		No screws	No screws	No screws	No screws	No screws
Flow direction		Reversible	Reversible	Reversible	Reversible	Reversible
Bearing		Bearings	Bearings	Bearings	Bearings	Bearings
Dimensions	mm (WxHxD)	105x105x67	105x105x67	150x150x71	150x150x71	204x204x98
Colour	RAL	7035	7035	7035	7035	7035
Approvals		CE, UL	CE, UL	CE, UL	CE, UL	CE, UL

In any forced ventilation kit, the fan wheel is balanced. In the larger sizes (cod. EN2325K and cod. EN3325K) there is the balancing clip. The balanced fan wheel ensures less noise and absorption.

In-depth technical information

Ventilation and air conditioning

EN2204K	EN1250K	EN2250K	EN2325K	EN3325K
120/135	240/270	240/270	520/580	520/580
115	230	115	230	115
50/60	50/60	50/60	50/60	50/60
17/15	29/29	30/30	67/87	50/64
0.200/0.160	0.132/0.130	0.265/0.274	0.300/0.382	0.540/0.650
2700	2800	2800	2770	3120
46/50	50/55	50/55	65/68	66/69
-10+50	-10+50	-10+50	-10+50	-10+55
45.000	45.000	45.000	50.000	53.000
54	54	54	54	54
I	I	I	I	I
1,1	1,7	1,7	3,7	3,7
Impedance	Thermal	Thermal	Thermal	Thermal
3-pole term.	3-pole term.	3-pole term.	3-pole term.	3-pole term.
No screws	No screws	No screws	No screws	No screws
Reversible	Reversible	Reversible	Reversible	Reversible
Bearings	Bearings	Bearings	Bearings	Bearings
204x204x98	250x250x121	250x250x121	325x325x161	325x325x161
7035	7035	7035	7035	7035
CE, UL	CE, UL	CE, UL	CE	CE

Chapter 7

Overall dimensions

7-2 SRX enclosures

7-4 AMX cabinets

7-9 ISX cabinets

**7-26 Natural ventilation, forced ventilation,
air conditioning**

7-28 Drilling

7-29 Accessories

Overall dimensions

SRX enclosures

Basic version

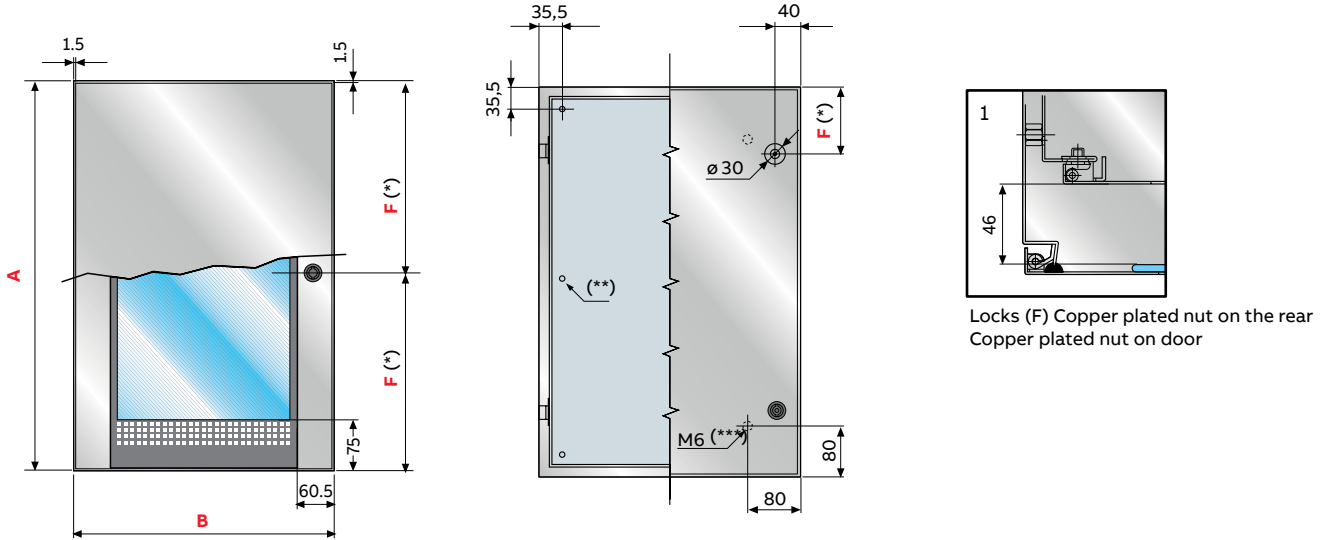

Modular panels and inner door

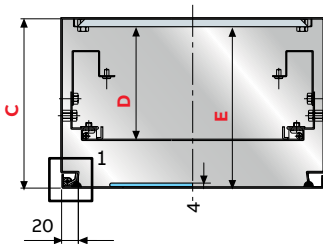

Code	A	B	C	D	E	F (*)	G	H	I	L
SRN3215X	303	203	147	82	133,5	151,5	163	337	237	263
SRN3415X	303	403	147	82	133,5	151,5	363	337	437	263
SRN4315X	403	303	147	82	133,5	201,5	263	437	337	363
SRN4320X	403	303	197	132	183,5	201,5	263	437	337	363
SRN4420X	403	403	197	132	183,5	201,5	363	437	437	363
SRN4620X	403	603	197	132	183,5	201,5	563	437	637	363
SRN5420X - SRN5420VX	503	403	197	132	183,5	251,5	363	537	437	463
SRN5520X	503	503	197	132	183,5	251,5	363	537	437	463
SRN6420X - SRN6420VX	603	403	197	132	183,5	100	363	637	437	563
SRN6620X	603	603	197	132	183,5	100	363	637	437	563
SRN6630X	603	603	297	232	283,5	100	363	637	437	563
SRN7525X - SRN7525VX	703	503	247	182	233,5	100	463	737	537	663
SRN8620X	803	603	197	132	183,5	150	363	637	437	563
SRN8625VX	803	603	247	182	233,5	150	563	837	637	763
SRN8630X	803	603	297	232	283,5	150	563	837	637	763
SRN8830X	803	803	297	232	283,5	150	763	837	837	763
SRN10830X - SRN10830VX	1003	803	297	232	283,5	150	763	1037	837	963
SRN12630X	1203	603	297	232	283,5	150	563	1237	637	1163
SRN12830X	1203	803	297	232	283,5	150	763	1237	837	1163

The measurements are given in millimeters

Overall dimensions

SRX enclosures

Centre distances for wall-mounting

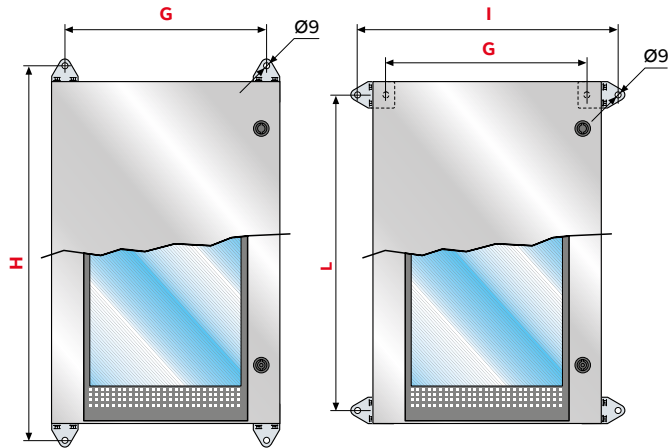

Centre distances for plinth fixing

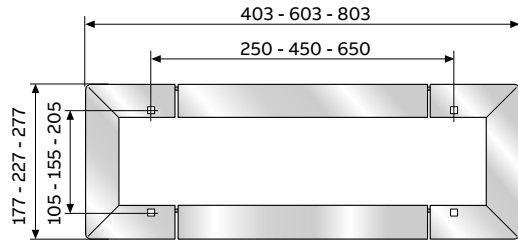

Inner doors

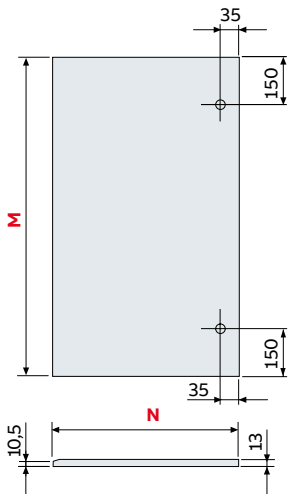

Internal plates

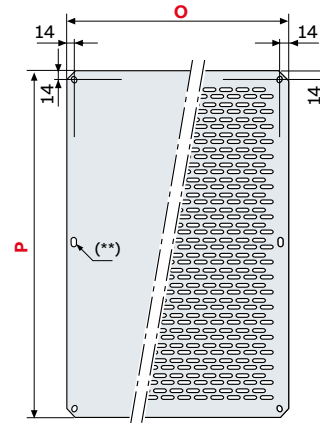

Code	M	N
KC5040X*	456	360
KC6040X*	556	360
KC7050X*	656	460
KC8060X	756	560
KC1080X	956	760

* Inner doors with H 500mm, 600mm, 700mm only have one hole in the centre for the lock

Code	O	P
PF3020	160	260
PF3030	260	260
PF3040 - PF4030	360	260
PF4040	360	360
PF5030	260	460
PF5040	360	460
PF5050	460	460
PF6040 - PF4060	360	560
PF6060	560	560
PF7050	460	660
PF8060	560	760
PF8080	760	760
PF1060	560	960
PF1080	760	960
PF1260	560	1160
PF1280	760	1160

The measurements are given in millimeters

Overall dimensions

AMX cabinets

Structure

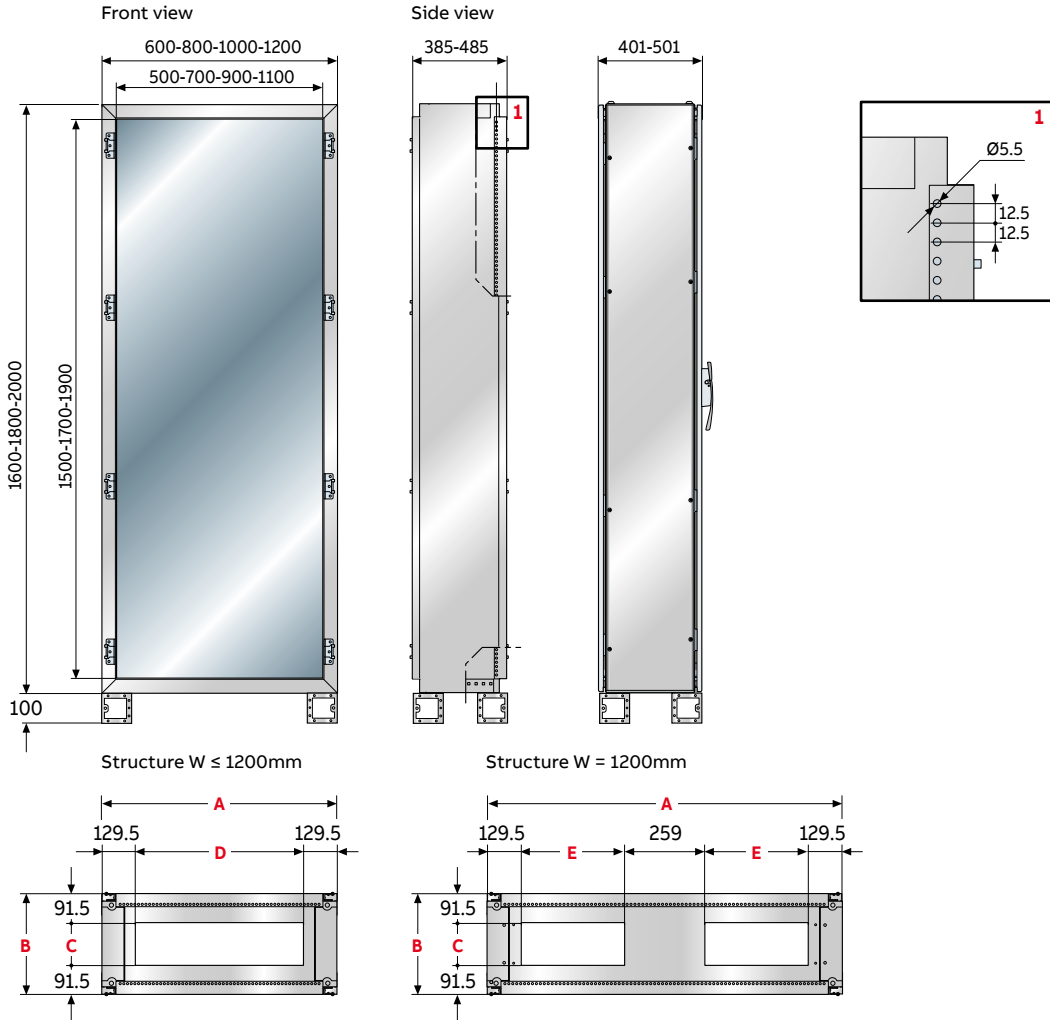

A	B	C	D	E
600	385	202	341	
	485	302	341	
800	385	202	541	
	485	302	541	
1000	385	202	741	
	485	302	741	
1200	385	202		341
	485	302		341

The measurements are given in millimeters

Overall dimensions

AMX cabinets

Front/rear covers

Blind or glazed door H=1600/1800/2000mm

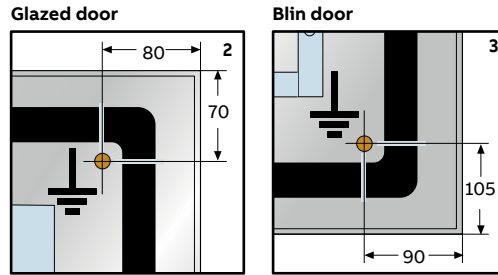
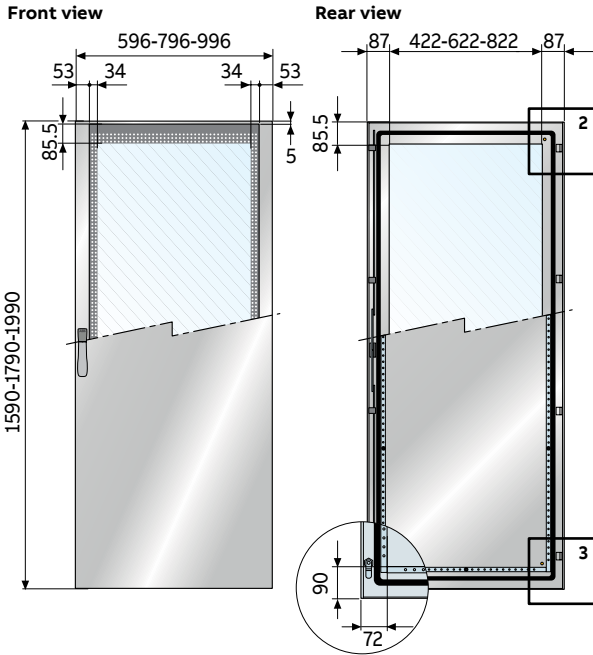

Fixing to wall/floor

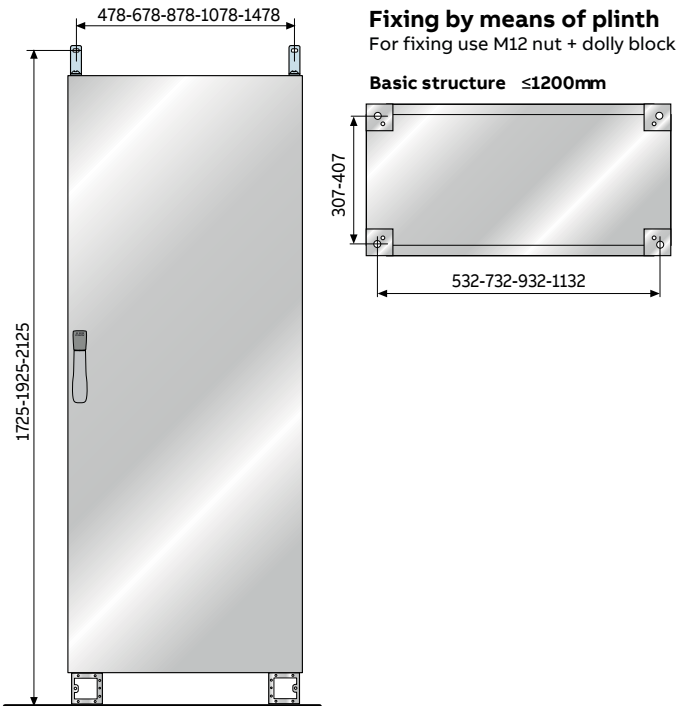

Flanges for passage of sliding cables

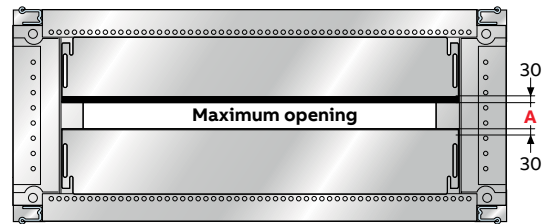

Structure D (mm)	A
400	40
500	60

Overall dimensions

AMX cabinets

Kit for modular apparatus

DIN rail kit

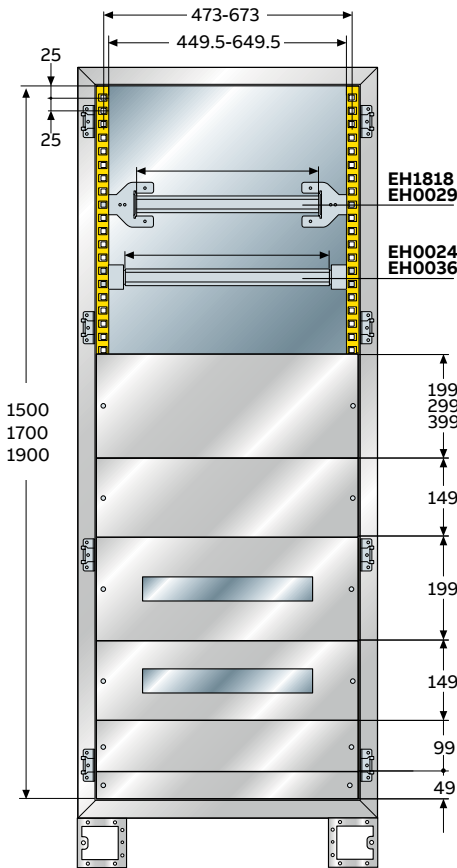

Panels for modular instruments, blind panels

Panels for modular instruments

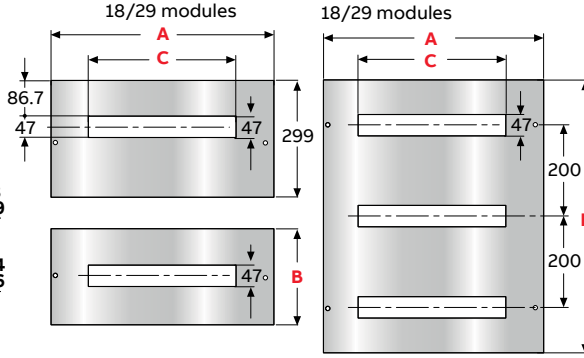

Flat and recessed blind panels

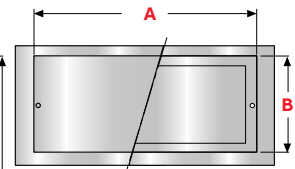

Panels for modular instruments 1 DIN row

Code	A	B	C	N mod.
EH1518X	489.5	149	324.5	18
EH2018X	489.5	199	324.5	18
EH3018X	489.5	299	324.5	18
EH1529X	689.5	149	524.5	29
EH2029X	689.5	199	524.5	29
EH3029X	689.5	299	524.5	29
EH1524X	489.5	149	432	24
EH2024X	489.5	199	432	24
EH1536X	689.5	149	634	36
EH2036X	689.5	199	634	36

Opaque panels

Flush	Recessed	A	B
EH0562X		489.5	49
EH1062X		489.5	99
EH1562X		489.5	149
EH2062X	EH2063X	489.5	199
EH3063X	EH3064X	489.5	299
EH4062X	EH4064X	489.5	299
EH5062X	EH5063X	489.5	499
EH6062X	EH6063X	489.5	599
EH0582X		689.5	49
EH1082X		689.5	99
EH1582X		689.5	149
EH2082X	EH2083X	689.5	199
EH3082X	EH3083X	689.5	299
EH4082X	EH4083X	689.5	299
EH5082X	EH5084X	689.5	499
EH6082X	EH6084X	689.5	599

Panels for modular instruments 3 DIN rows

Code	A	B	C	N mod.
EH6018X	489.5	599	324.5	18
EH6029X	689.5	599	524.5	29
EH6025X	489.5	599	324.5	24
EH6036X	689.5	599	524.5	36

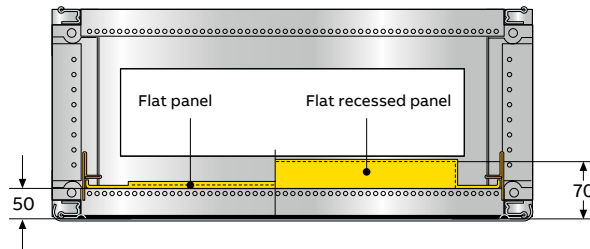

Instruments panels

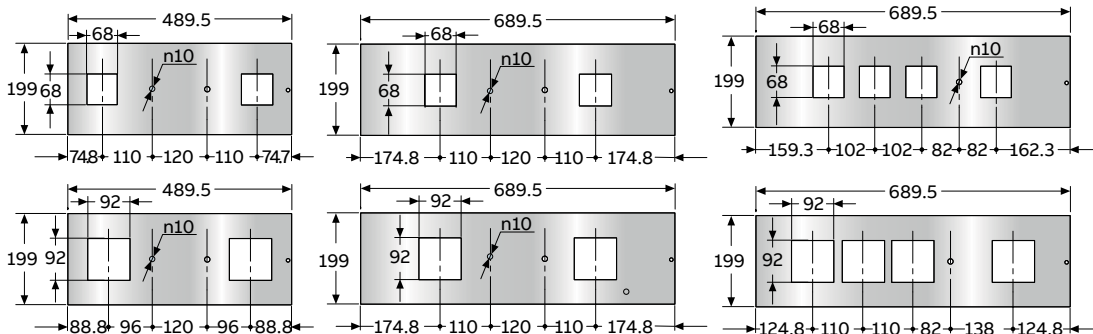

The measurements are given in millimeters

Overall dimensions

AMX cabinets

19" rack frames

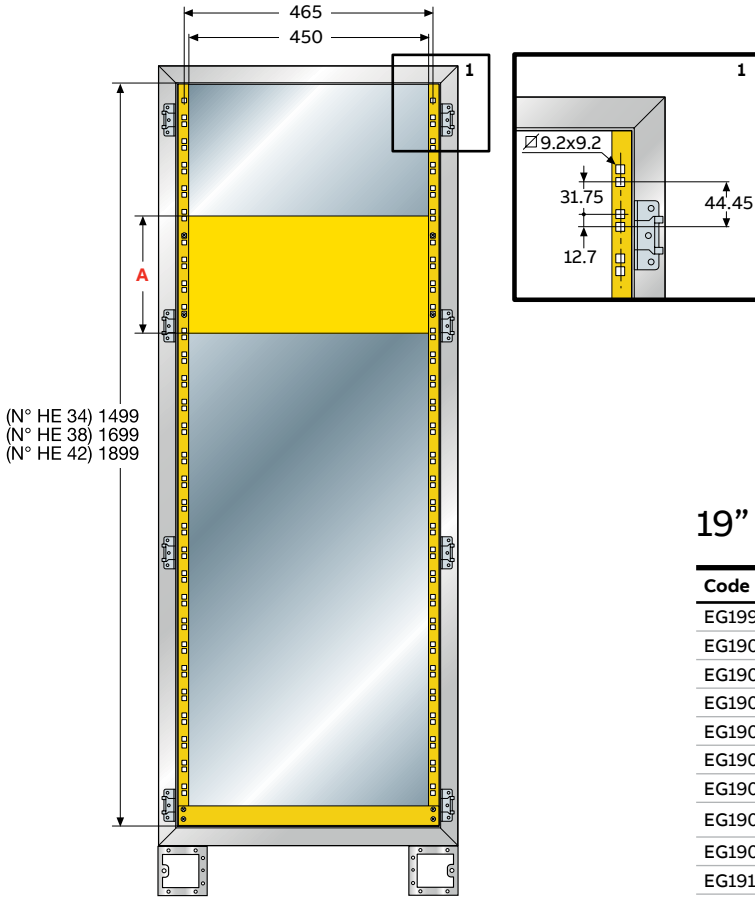

(N° HE 34) 1499
 (N° HE 38) 1699
 (N° HE 42) 1899

19" rack frame panels

Code	A	No. HE
EG1991	44.45	1
EG1902	89	2
EG1903	133	3
EG1904	177.5	4
EG1905	222	5
EG1906	266.5	6
EG1907	311	7
EG1908	355.5	8
EG1909	400	9
EG1910	444.5	10
EG1911	488	11
EG1912	533	12
EG1913	577.5	13
EG1914	622	14
EG1915	666	15
EG1916	711	16
EG1917	755.5	17
EG1918	800	18
EG1999	844.5	19
EG1920	889	20

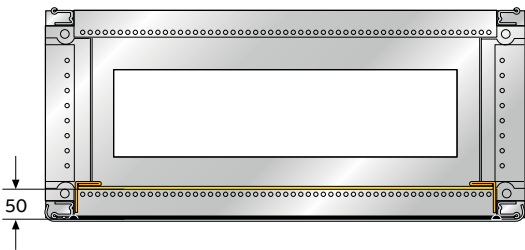

Overall dimensions

ISX cabinets

Basic structure

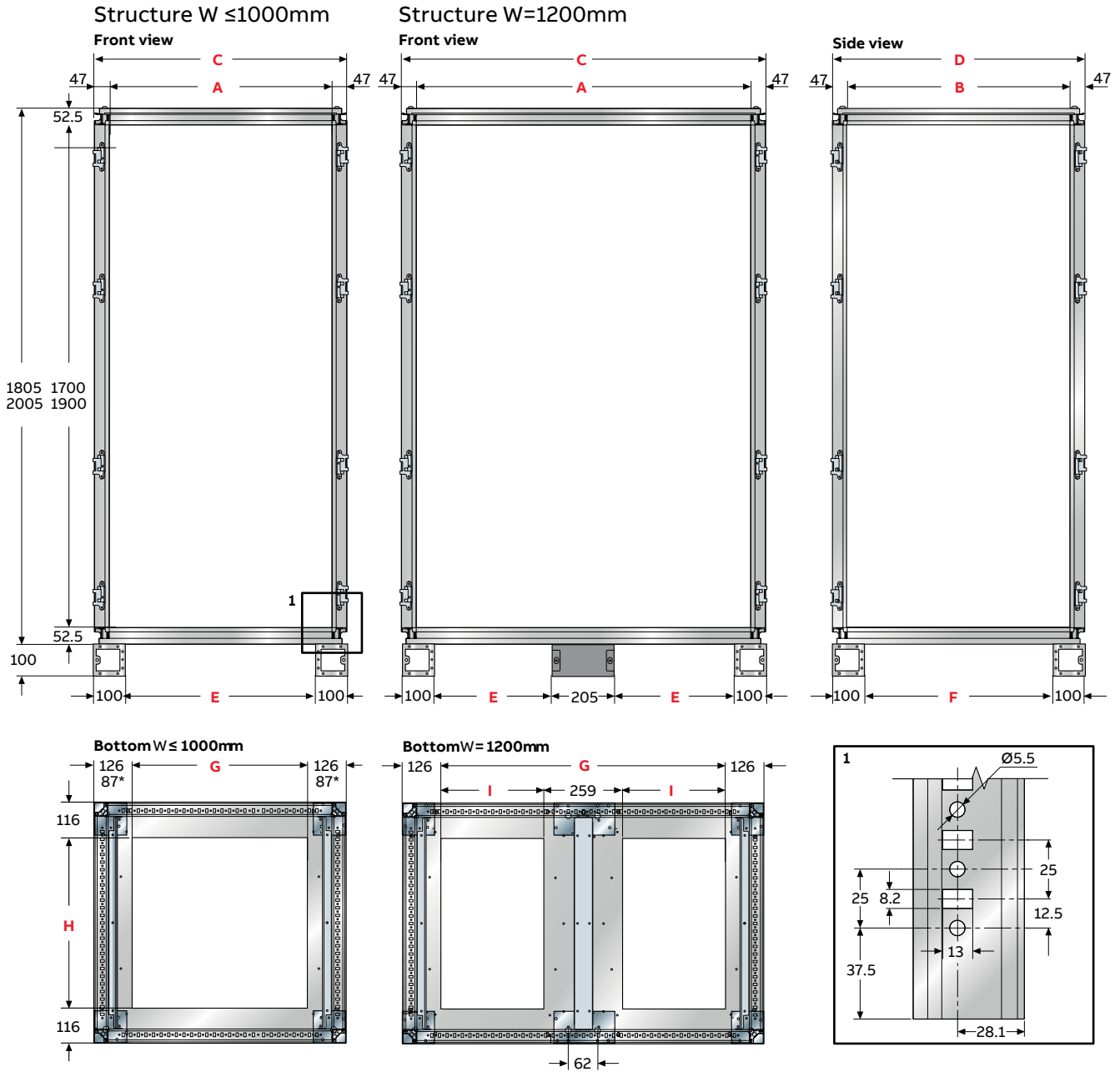

	A	B	C	D	E	F	G	H
		300		394		193		162
500		400	594	494	393	293	342	262
		500		594		393		362
		300		394		193		239
700		400	794	494	593	293	542	339
		500		594		393		439

	A	B	C	D	E	F	G	H	I
		300		394		193		162	
900		400	994	494	793	293	742	262	
		500		594		393		362	
		300		394		193		162	
1100		400	1194	494	394	293	942	262	341.5
		500		594		393		362	

The measurements are given in millimeters

Overall dimensions

ISX cabinets

Placing structures side by side and fixing to the floor

Overall dimensions of several structures side by side

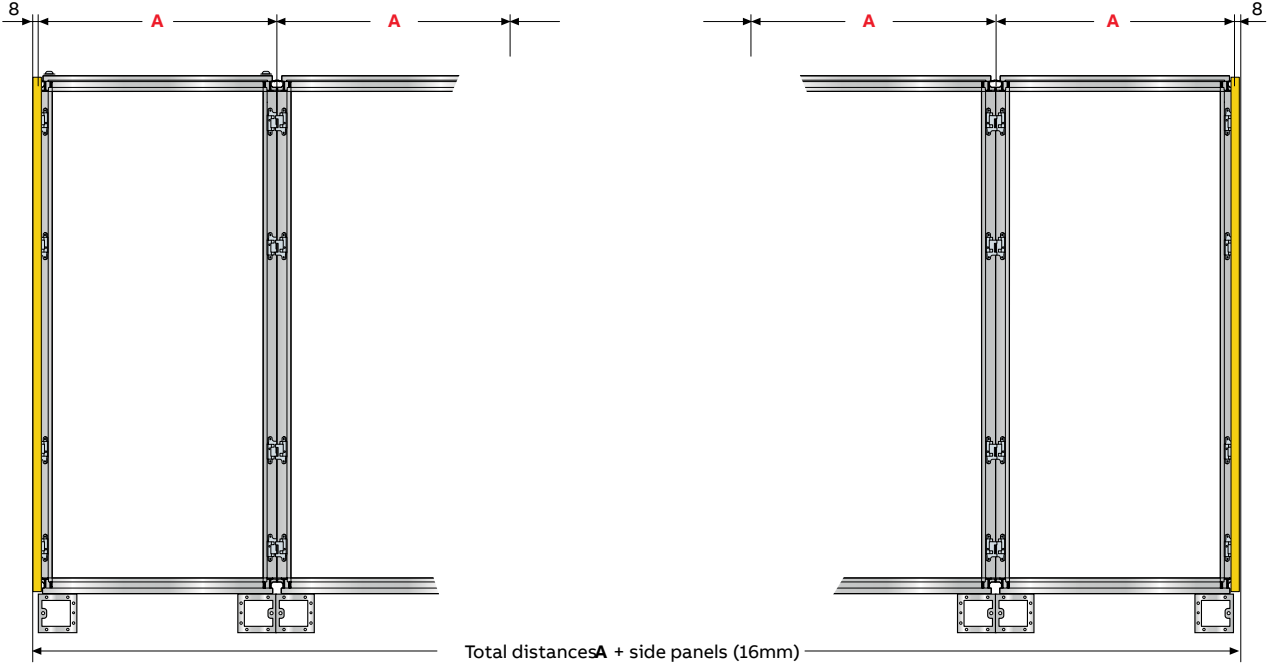

Fixing by means of plinth

For fixing, use M12 nut + dolly block

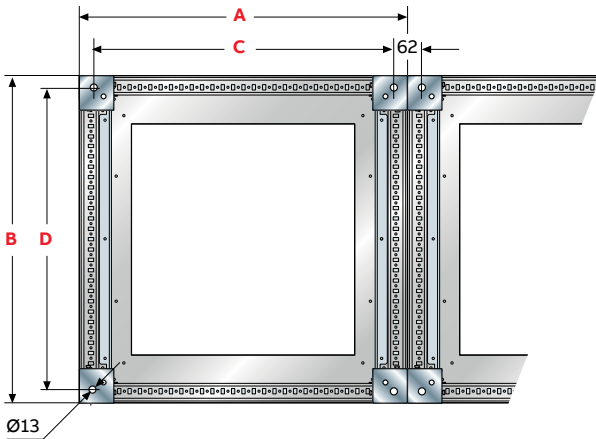

A	B	C	D
	394		332
594	494	532	432
	594		532
794	394		332
	494	732	432
	594		532
994	394		332
	494	932	432
	594		532
1194	394		332
	494	1132	432
	594		532

The measurements are given in millimeters

7

Overall dimensions

ISX cabinets

Version with opaque or transparent door

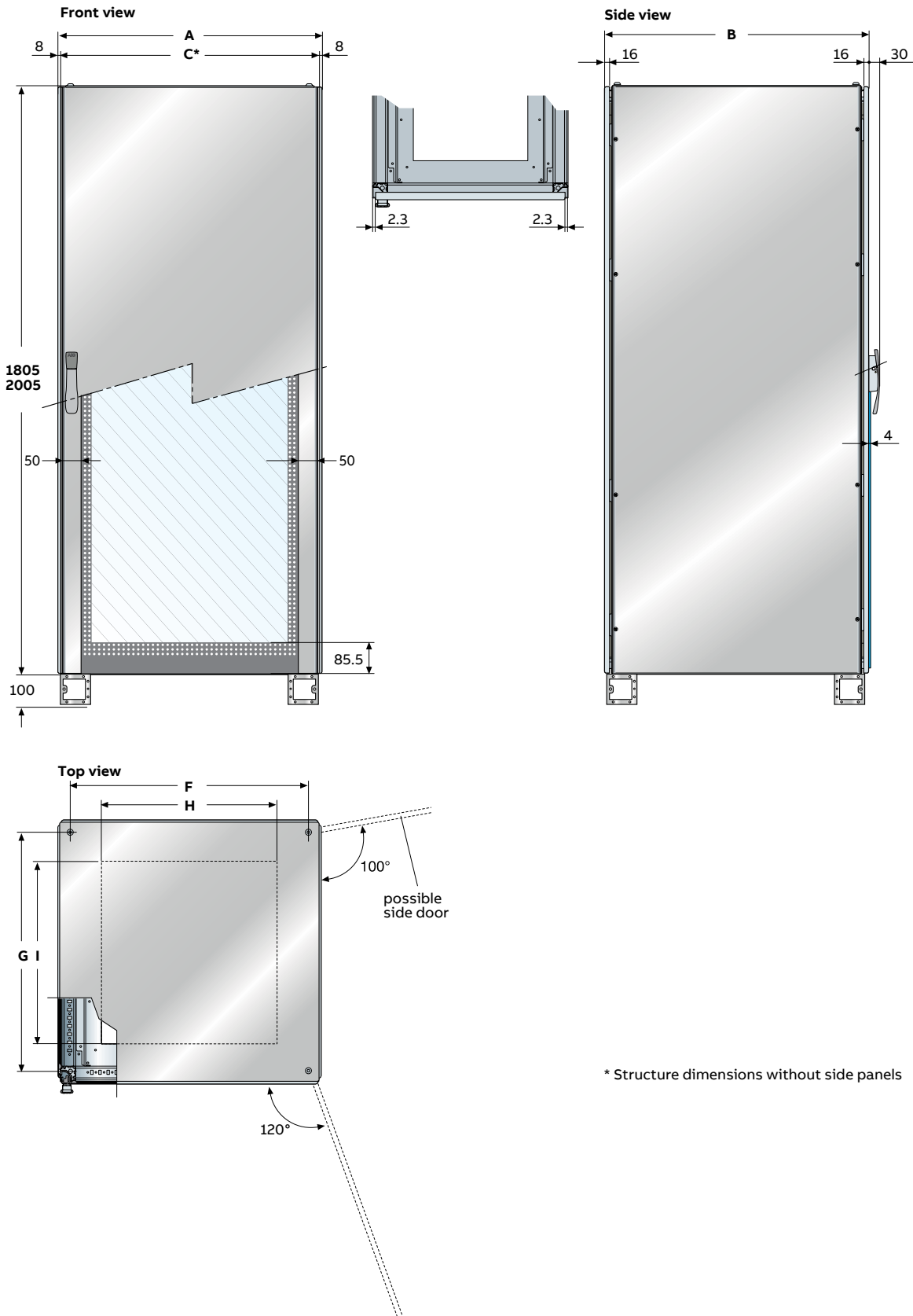

The measurements are given in millimeters

Overall dimensions

ISX cabinets

Version with opaque double doors

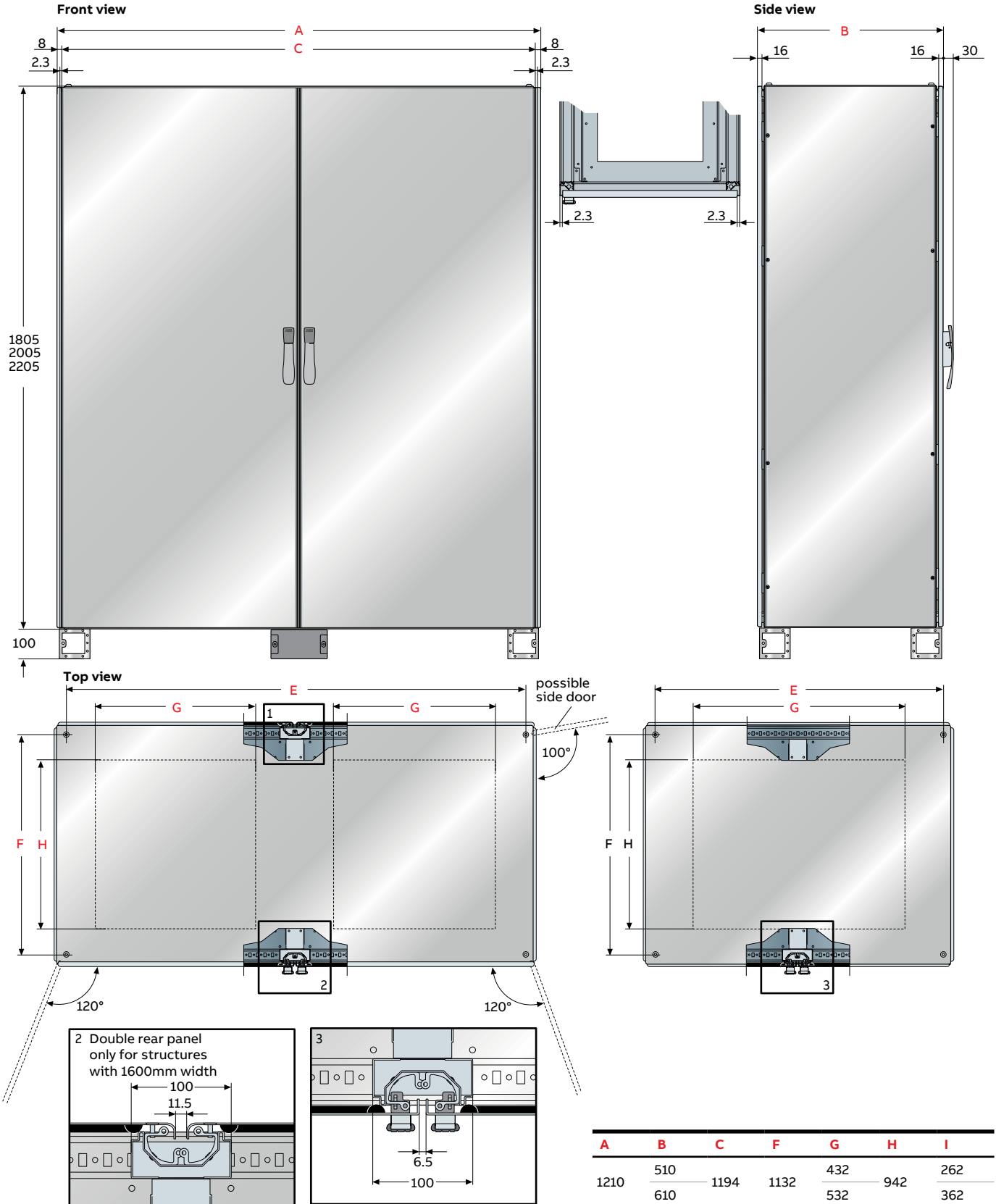

The measurements are given in millimeters

7

Overall dimensions

ISX cabinets

19" rack frames

Fixed rack frame

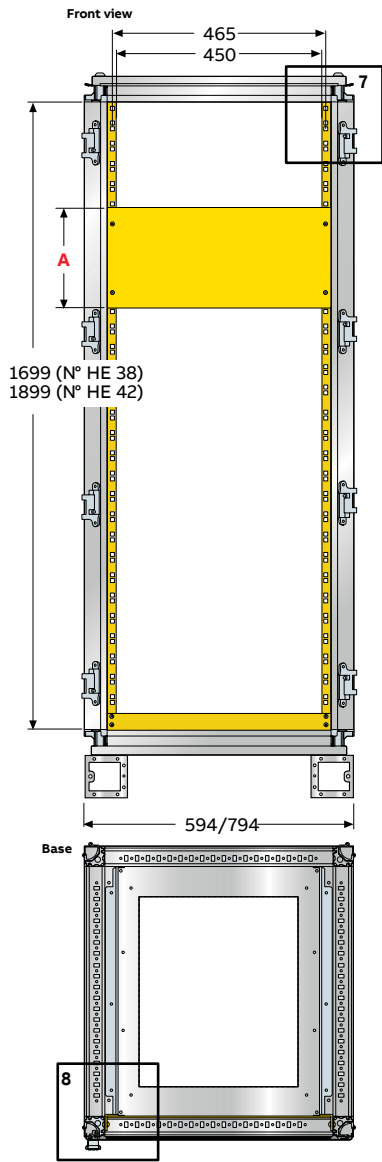

Swing rack frame fixed rack frame

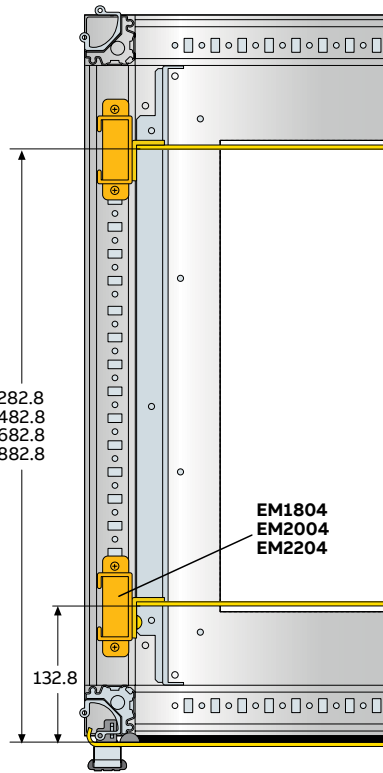

Swing rack frame W=600mm

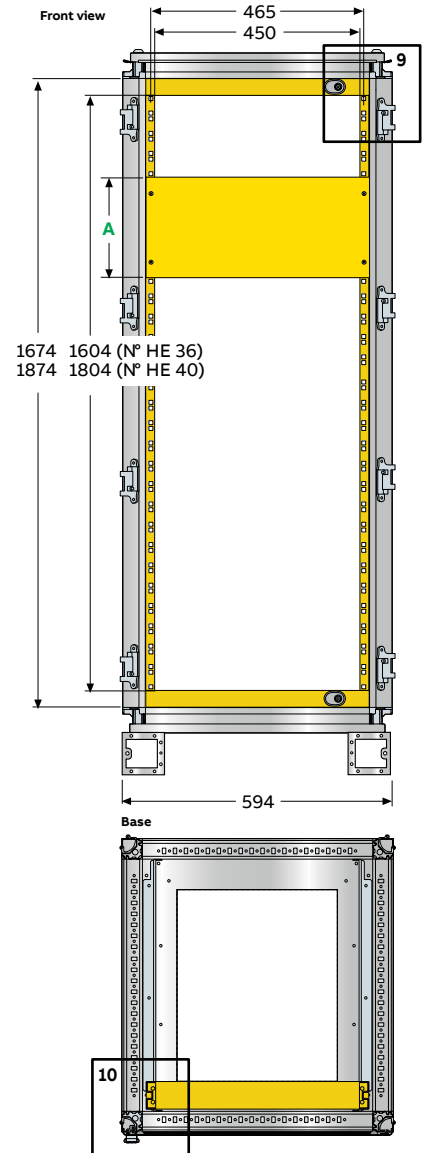

19" rack frame panels

Code	A	No. HE
EG1991	44.45	1
EG1902	89	2
EG1903	133	3
EG1904	177.5	4
EG1905	222	5
EG1906	266.5	6
EG1907	311	7
EG1908	355.5	8
EG1909	400	9
EG1910	444.5	10

Code	A	No. HE
EG1911	488	11
EG1912	533	12
EG1913	577.5	13
EG1914	622	14
EG1915	666	15
EG1916	711	16
EG1917	755.5	17
EG1918	800	18
EG1999	844.5	19
EG1920	889	20

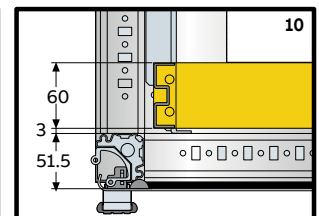
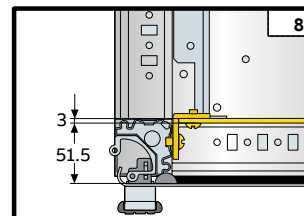
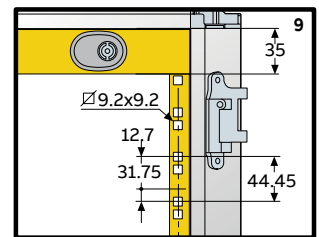
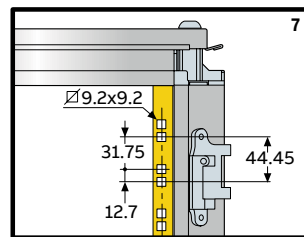

The measurements are given in millimeters

Overall dimensions

ISX cabinets

19" rack frames

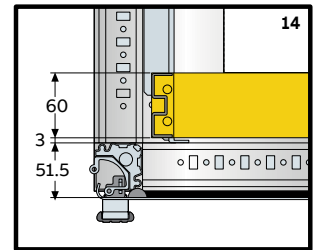
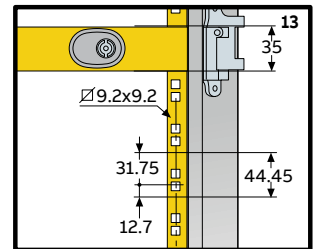
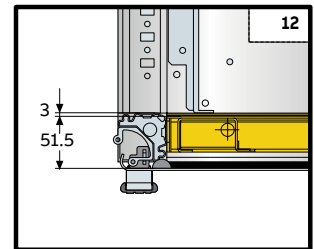
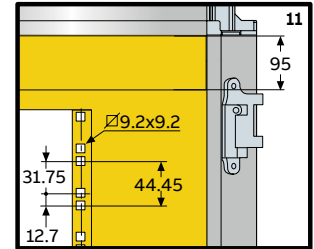
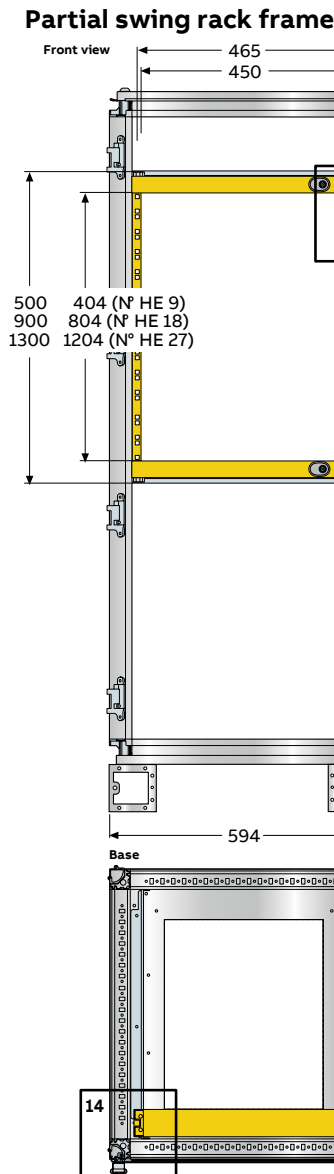
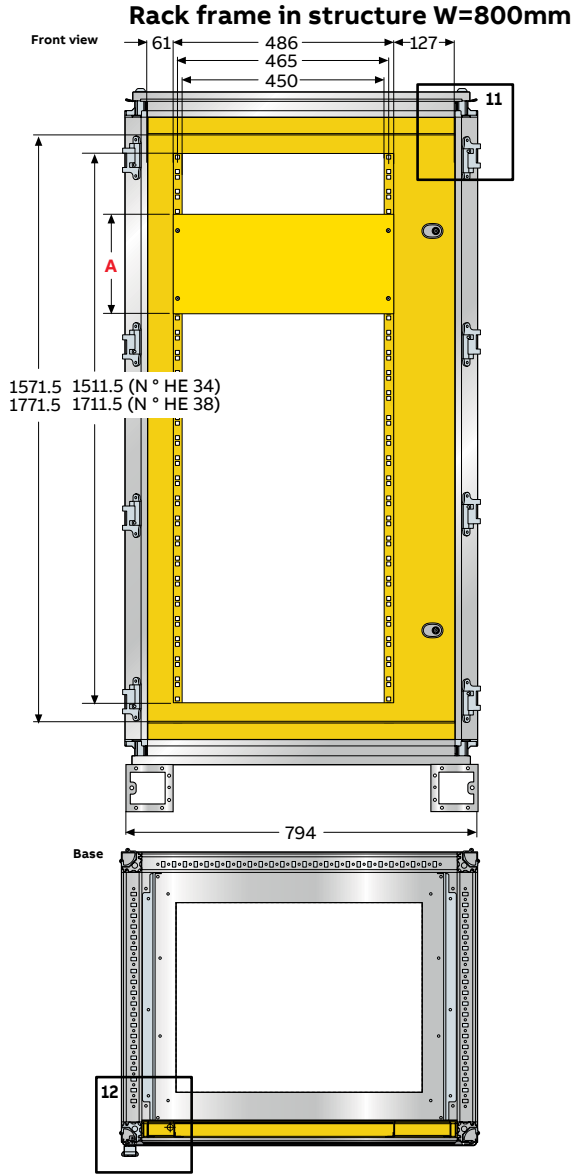

19" rack frame panels

Code	A	No. HE	Code	A	No. HE
EG1991	44.45	1	EG1911	488	11
EG1902	89	2	EG1912	533	12
EG1903	133	3	EG1913	577.5	13
EG1904	177.5	4	EG1914	622	14
EG1905	222	5	EG1915	666	15
EG1906	266.5	6	EG1916	711	16
EG1907	311	7	EG1917	755.5	17
EG1908	355.5	8	EG1918	800	18
EG1909	400	9	EG1999	844.5	19
EG1910	444.5	10	EG1920	889	20

Maximum overall apparatus installation dimensions in 19" swing rack frames

Swing rack frame with 90° opening

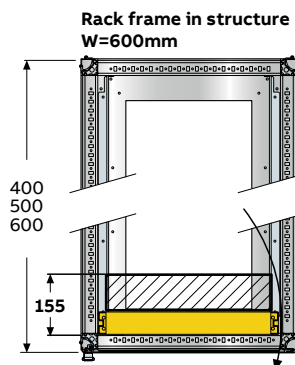

Swing rack frame with 150° opening

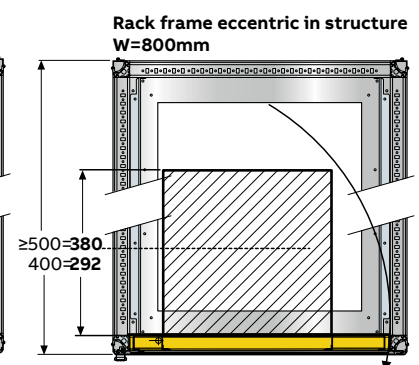

The measurements are given in millimeters

Overall dimensions

ISX cabinets

Version with kit for modular apparatuses

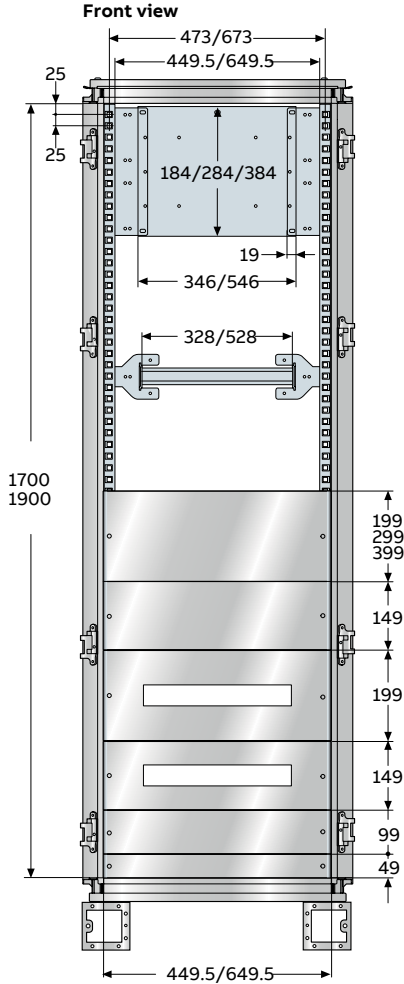

Panels for modular instruments, blind panels

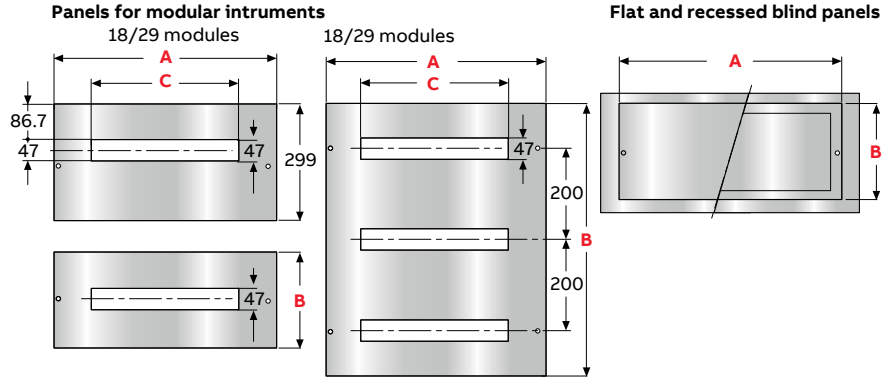

Panels for modular instruments 1 DIN row

Code	A	B	C	No. of mod.
EH1518X	489.5	149	324.5	18
EH2018X	489.5	199	324.5	18
EH3018X	489.5	299	324.5	18
EH1529X	689.5	149	524.5	29
EH2029X	689.5	199	524.5	29
EH3029X	689.5	299	524.5	29
EH1524X	489.5	149	432	24
EH2024X	489.5	199	432	24
EH1536X	689.5	149	634	36
EH2036X	689.5	199	634	36

Opaque panels

Flush	Recessed	A	B
EH0562X		489.5	49
EH1062X		489.5	99
EH1562X		489.5	149
EH2062X	EH2063X	489.5	199
EH3063X	EH3064X	489.5	299
EH4062X	EH4064X	489.5	399
EH5062X	EH5063X	489.5	499
EH6062X	EH6063X	489.5	599
EH0582X		689.5	49
EH1082X		689.5	99
EH1582X		689.5	149
EH2082X	EH2083X	689.5	199
EH3082X	EH3083X	689.5	299
EH4082X	EH4083X	689.5	399
EH5082X	EH5084X	689.5	499
EH6082X	EH6084X	689.5	599

Panels for modular instruments 3 DIN rows

Code	A	B	C	No. of mod.
EH6018X	489.5	599	324.5	18
EH6029X	689.5	599	524.5	29
EH6025X	489.5	599	432	24
EH6036X	689.5	599	634	36

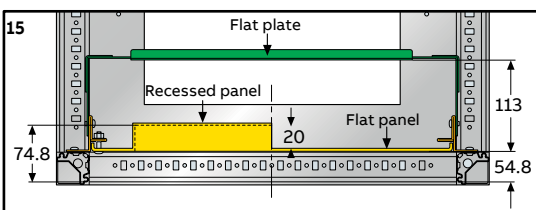
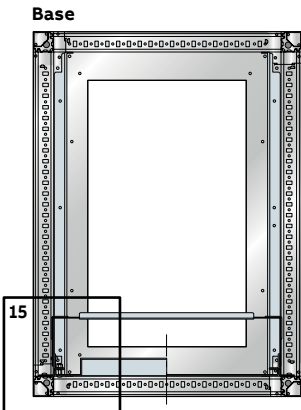

Instruments panels

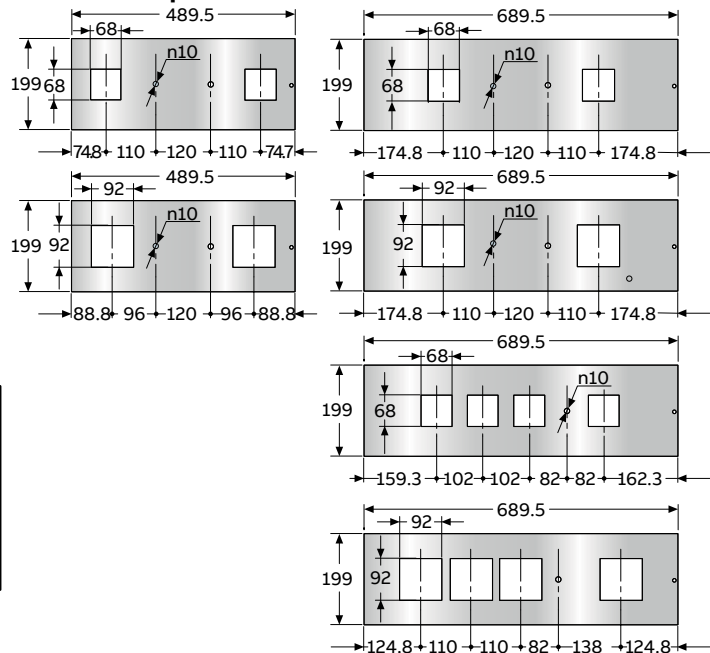

The measurements are given in millimeters

Overall dimensions

ISX cabinets

Back plates

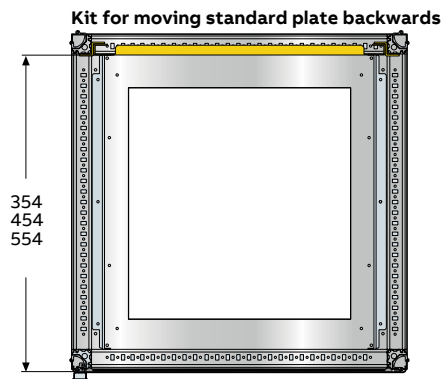
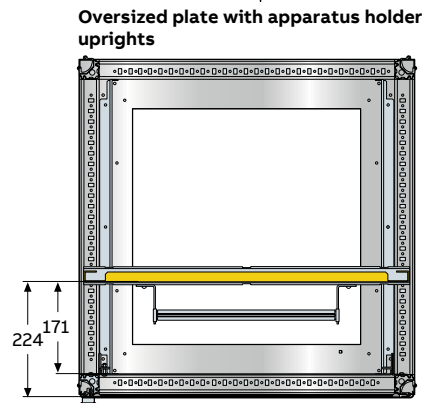
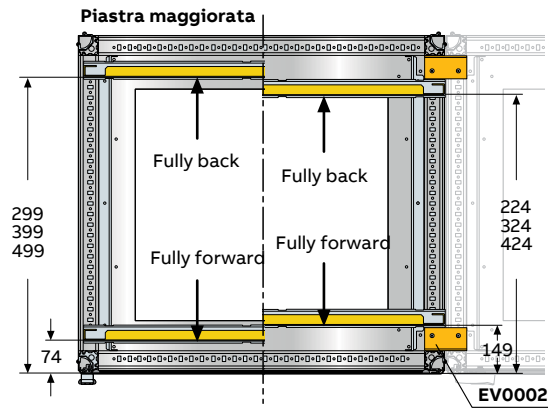
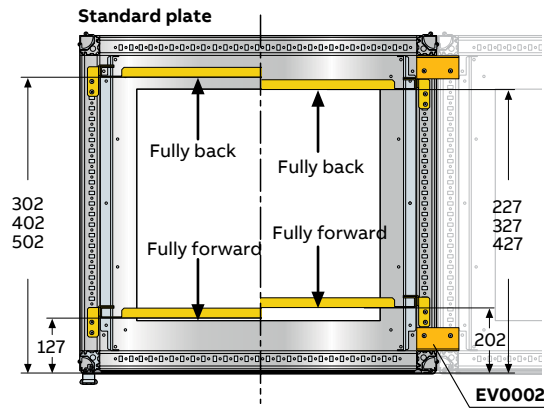
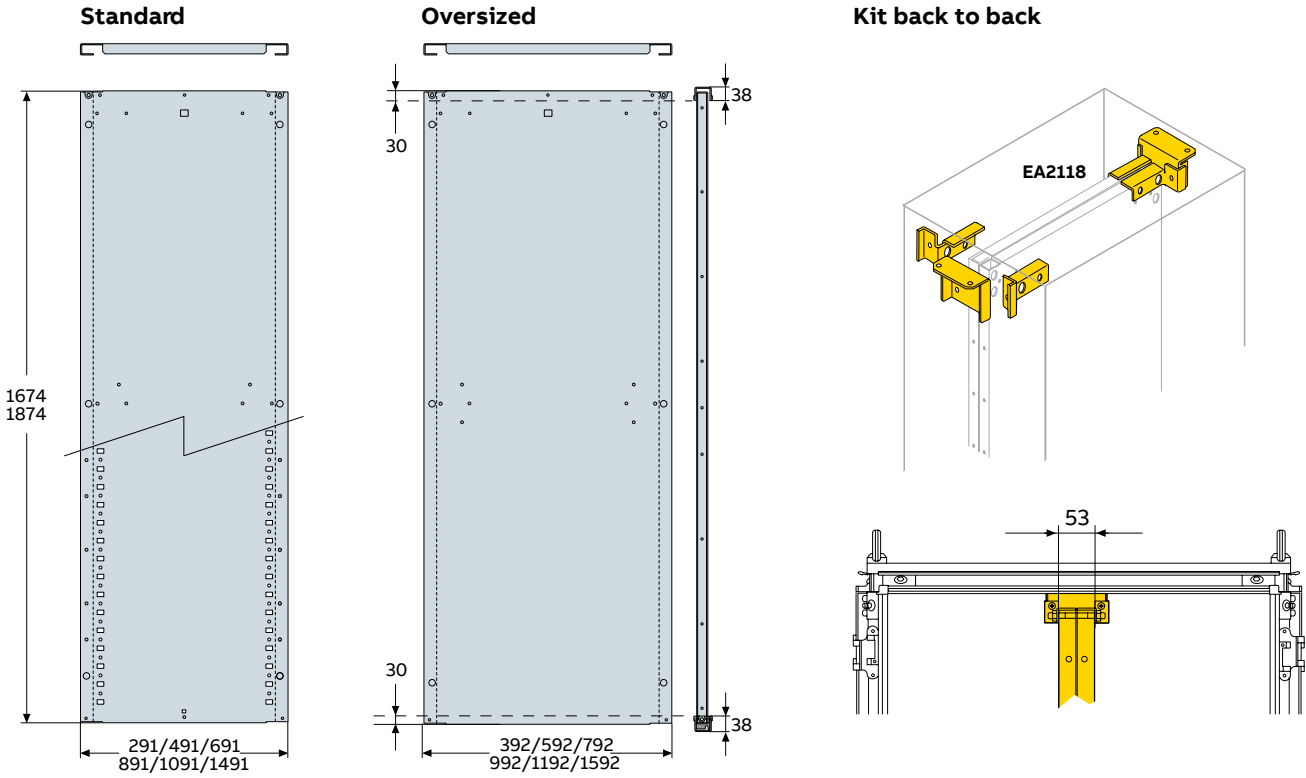

The measurements are given in millimeters

7

Overall dimensions

ISX cabinets

Back plates

Partial back plates

Do not require the depthwise upright

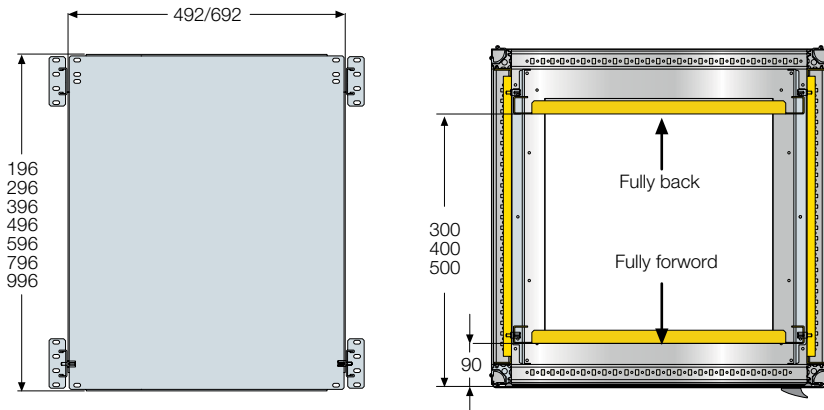

Back plates for condenser

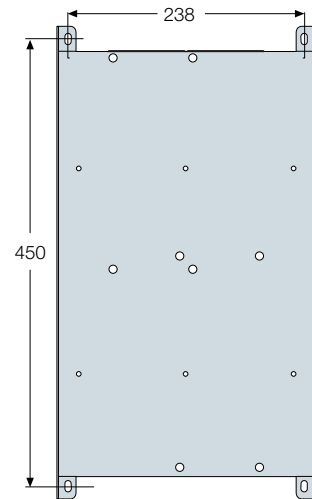

Selection of partial back plate and panels according to the apparatus to be installed

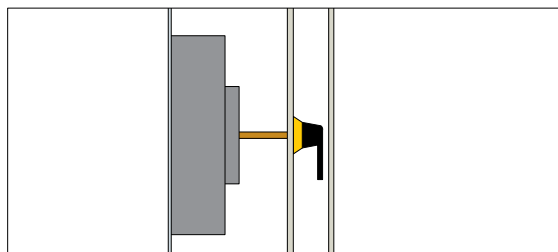

Handle between panel and door

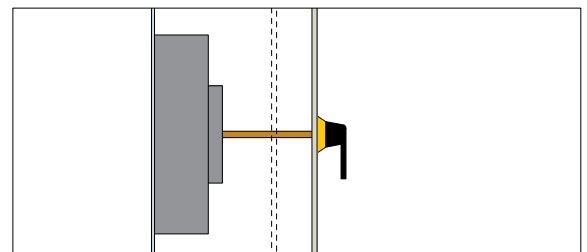

Handle transmitted onto the door

	Structures W=600mm			Structures W=800mm			Structures W=600mm			SStructures W=800mm		
	Partial back plate	Panel	H (mm)	Partial back plate	Panel	H (mm)	Partial back plate	Panel	H (mm)	Partial back plate	Panel	H (mm)
Disconnecting switches												
OT200/250	EA2062	EH2062K	200	EA2081	EH2082K	200	EH2065 ⁽²⁾	EH2062K	200	EH2085 ⁽²⁾	EH2082K	200
OT315/400	EA3061	EH3063K	300	EA3081	EH3082K	300	EA3061	EH3063K	300	EA3081	EH3082K	300
OT630/800	EA4061	EH4062K	400	EA4081	EH4082K	400	EA4061	EH4062K	400	EA4081	EH4082K	400
Circuit breakers												
Tmax T1-T2 -T3	EA2062	EH2063K ⁽¹⁾	200	EA2083 ⁽¹⁾	EH2083K	200	EH2065(2)	EH2062K	200	EH2085 ⁽²⁾	EH2082K	200
Tmax XT1-XT2-XT3-XT4	EA2062	EH2062K	200	EA2081	EH2082K	200						
Tmax T4-T5	EA4061	EH4062K	400	EA4081	EH4082K	200	EA4061	EH4062K	400	EA4081	EH4082K	200
Tmax T6	EA5061	EH5062K	500	EA5081	EH5082K	500	EA5061	EH5062K	500	EA5081	EH5082K	500

⁽¹⁾ Recessed opaque panel

⁽²⁾ Opaque apparatus holder back plate

The measurements are given in millimeters

Overall dimensions

ISX cabinets

Crosspieces for fixing accessories

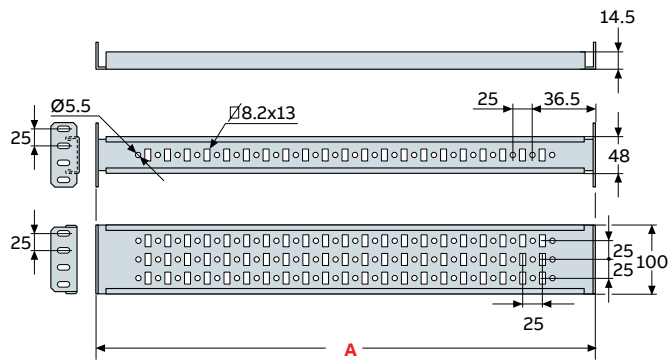

H=48mm

Code	A
EB0400	298
EB0500	398
EB0600	498
EB0800	698
EB1000	898
EB1200	1098

H=100mm

Code	A
EB0440	298
EB0550	398
EB0660	498
EB0880	698
EB1010	898
EB1012	1098

Section for accessories

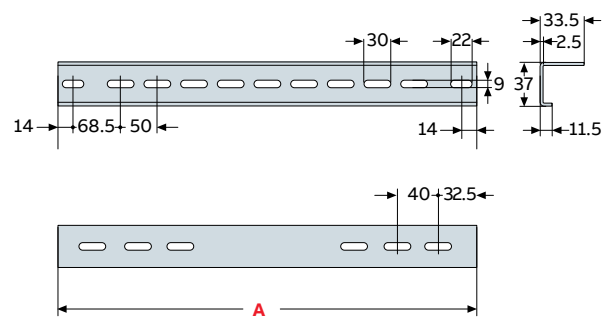

Code	A
TS0060	565
TS0080	765
TS0100	965
TS0120	1165
TS0160	1565

Overall dimensions

ISX cabinets

Front or rear doors

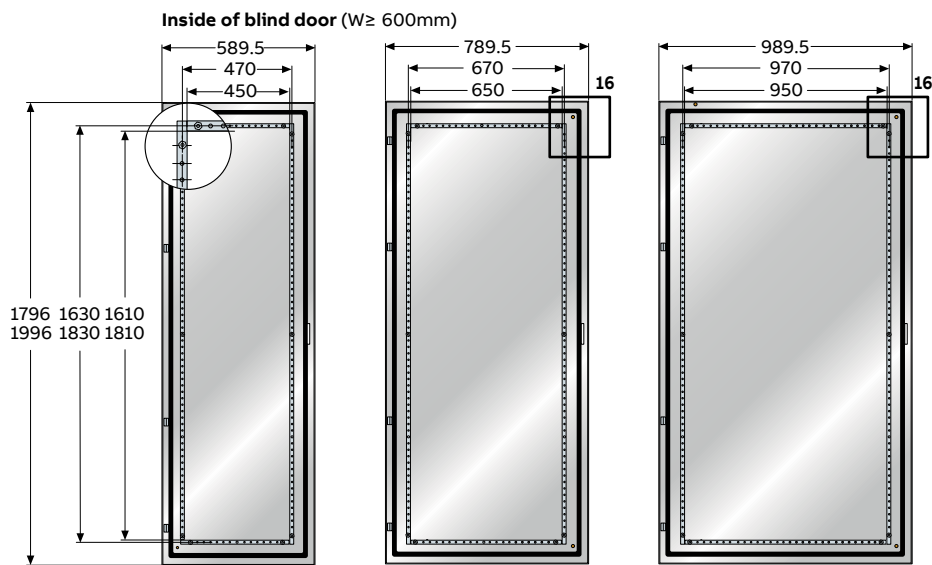
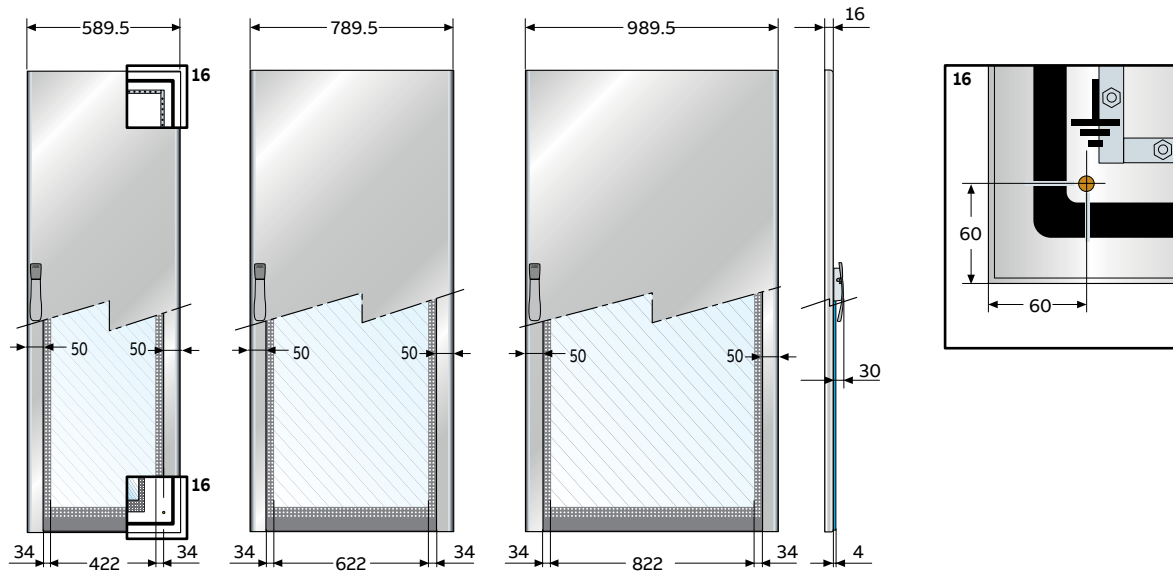

The measurements are given in millimeters

Overall dimensions

ISX cabinets

Double front or rear doors

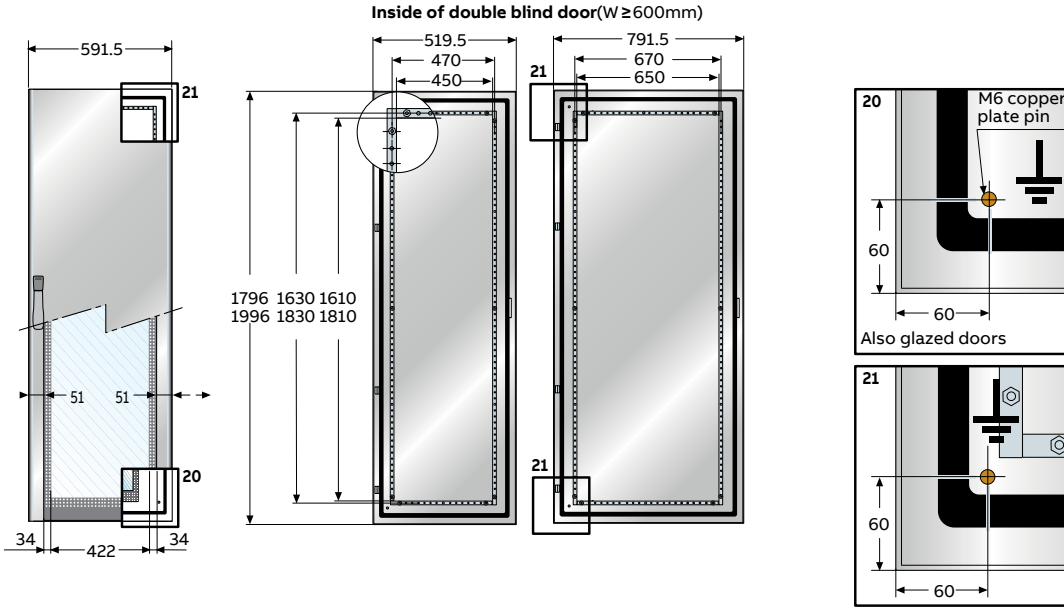

Side covers

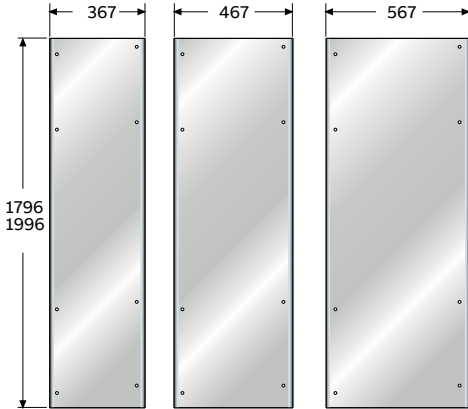

Example of use of double door

Mounting with blind doors with overlapping closure (without intermediate upright and crosspieces)

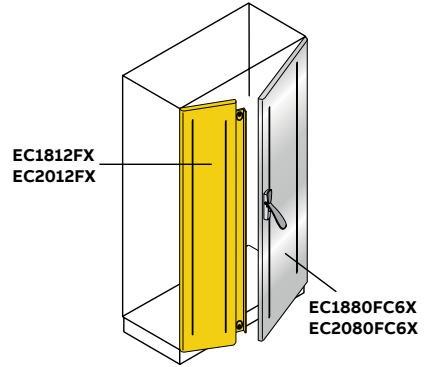

Overall dimensions

ISX cabinets

Opaque doors with overlap closing for double doors version

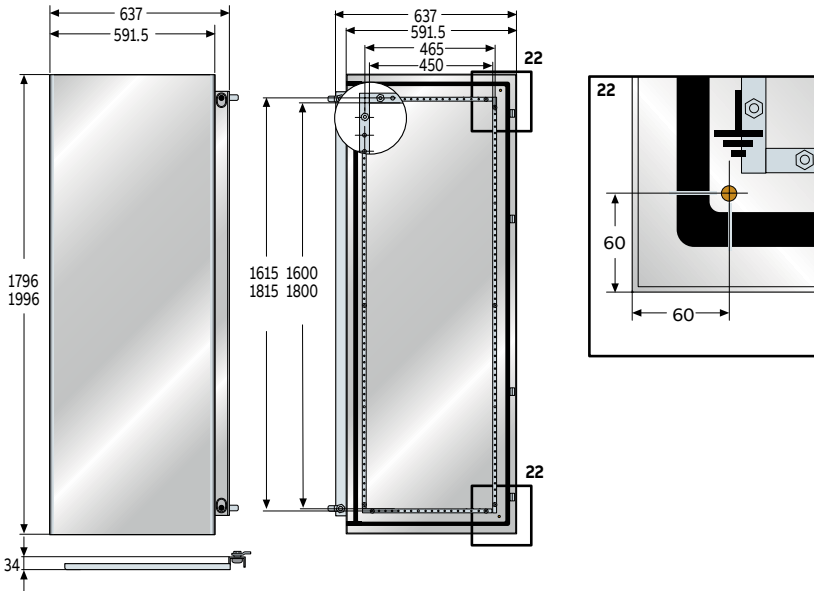

Rear panels

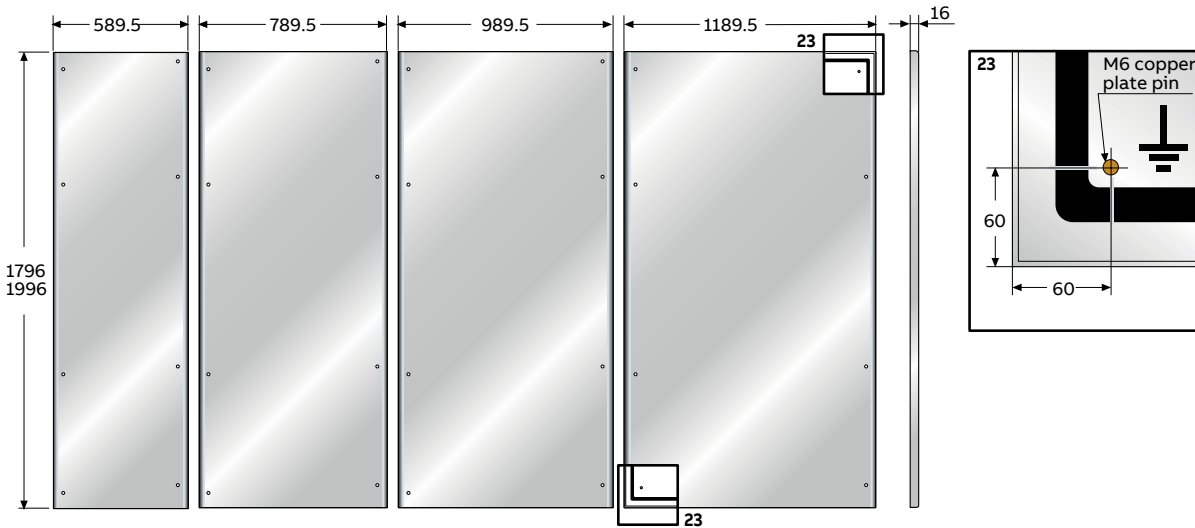

The measurements are given in millimeters

Overall dimensions

ISX cabinets

Inner doors

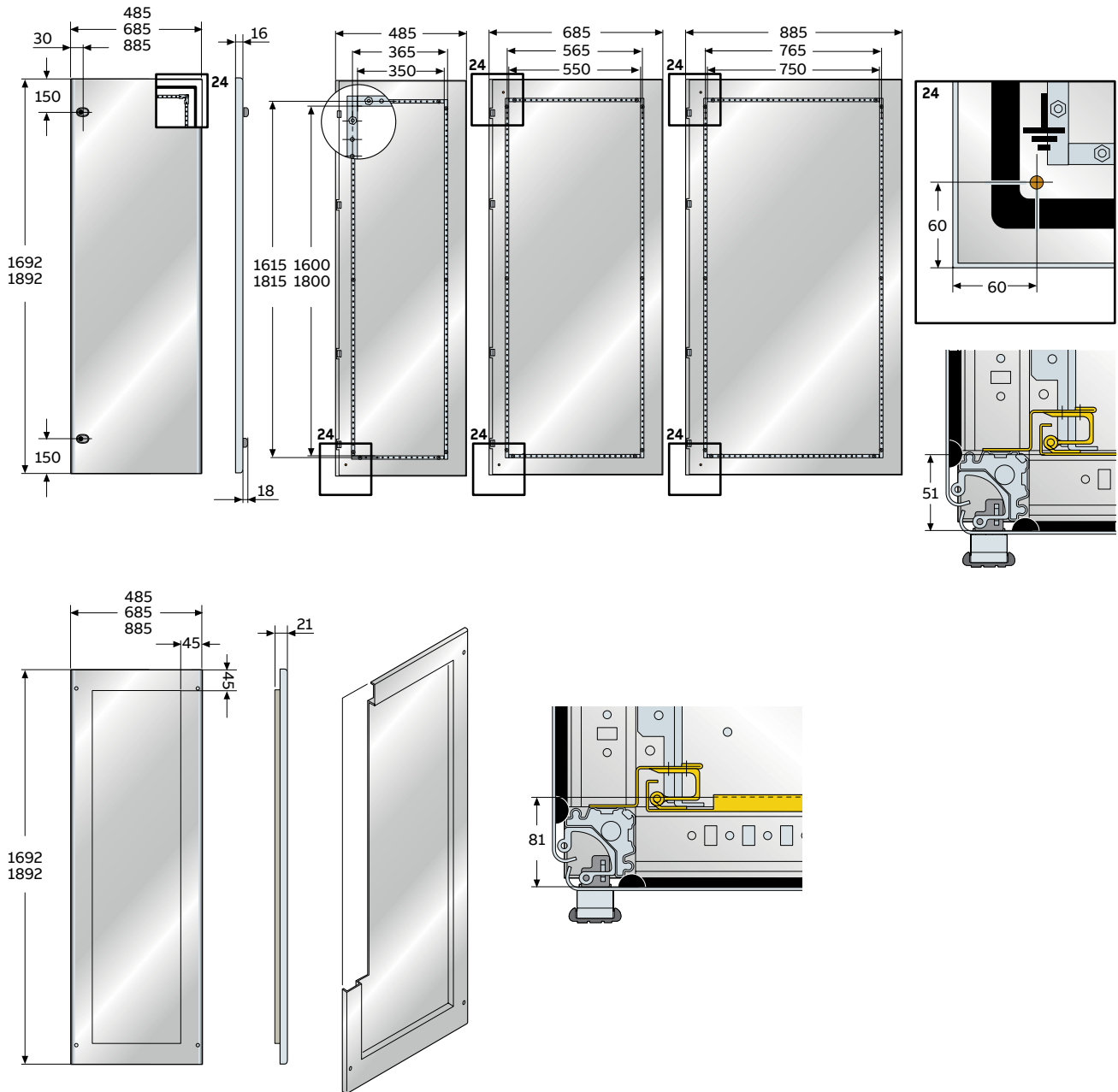

The measurements are given in millimeters

Overall dimensions

ISX cabinets

Flanges for passage of cables

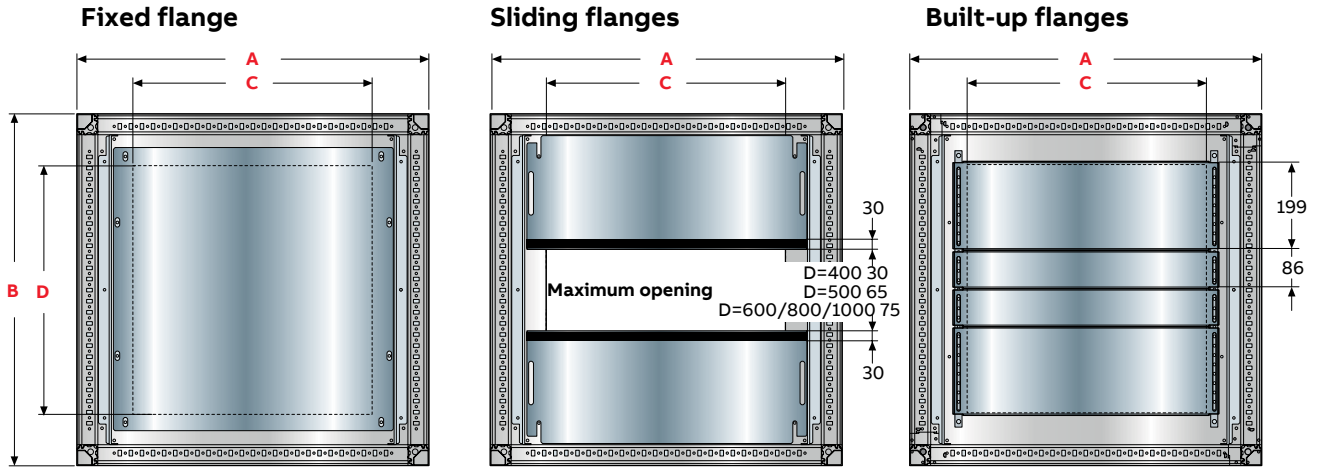

A	B	C	D	Modular flanges	
				No. of flanges H=199mm	No. of flanges H=86mm
594	394	342	162	-	2
	494		262	1	1
	594		362	1	2
794	394	542	162	-	2
	494		262	1	1
	594		362	1	2
994	394	742	162	-	2
	494		262	1	1
	594		362	1	2

The measurements are given in millimeters

Overall dimensions

ISX cabinets

Busbars with shaped section

Busbar

BA0400

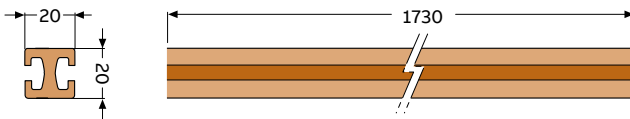

BA0800

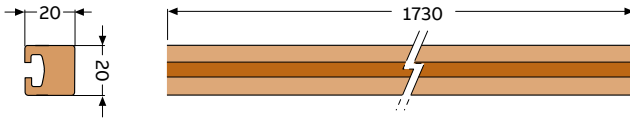

BA1250

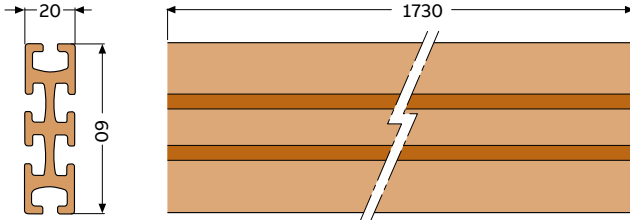

BA1600

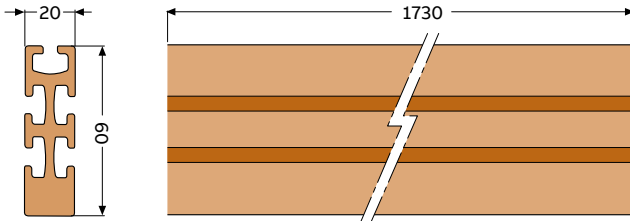

Insulator

PB 0803

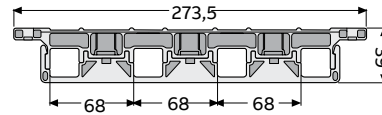

PB 1603

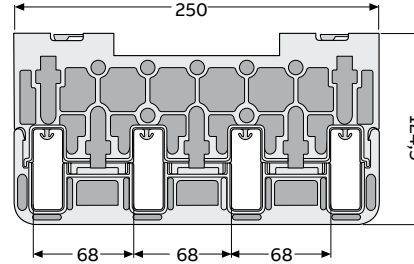

Accessories

AD1077

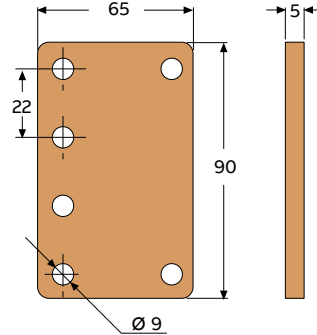

Overall dimensions

ISX cabinets

Flat busbars

Busbar up to 630A

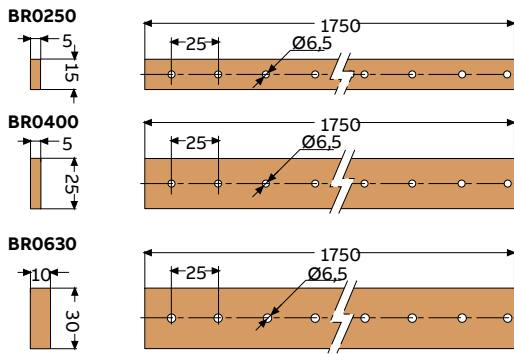

Insulators for busbars up to 630A

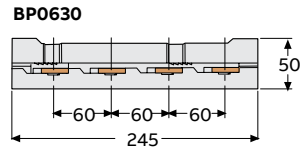

Busbar up to 1600A

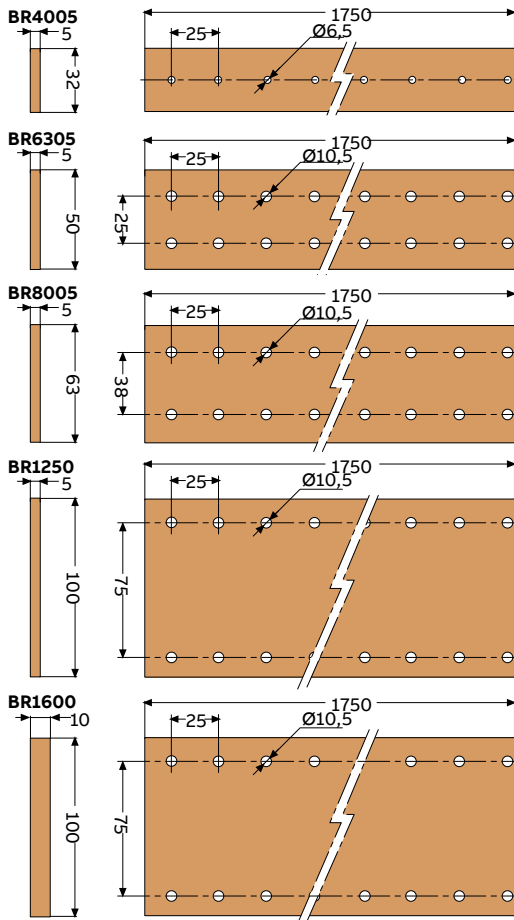

Insulators for busbars up to 1600A

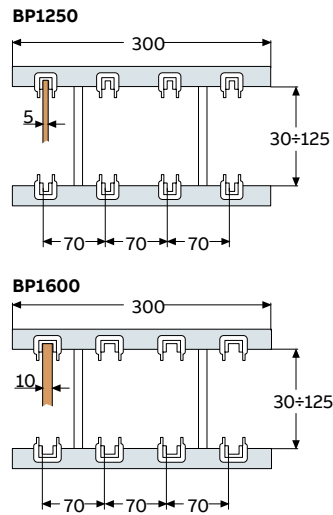

Overall dimensions

Natural ventilation/forced ventilation/air conditioning

Natural ventilation kit

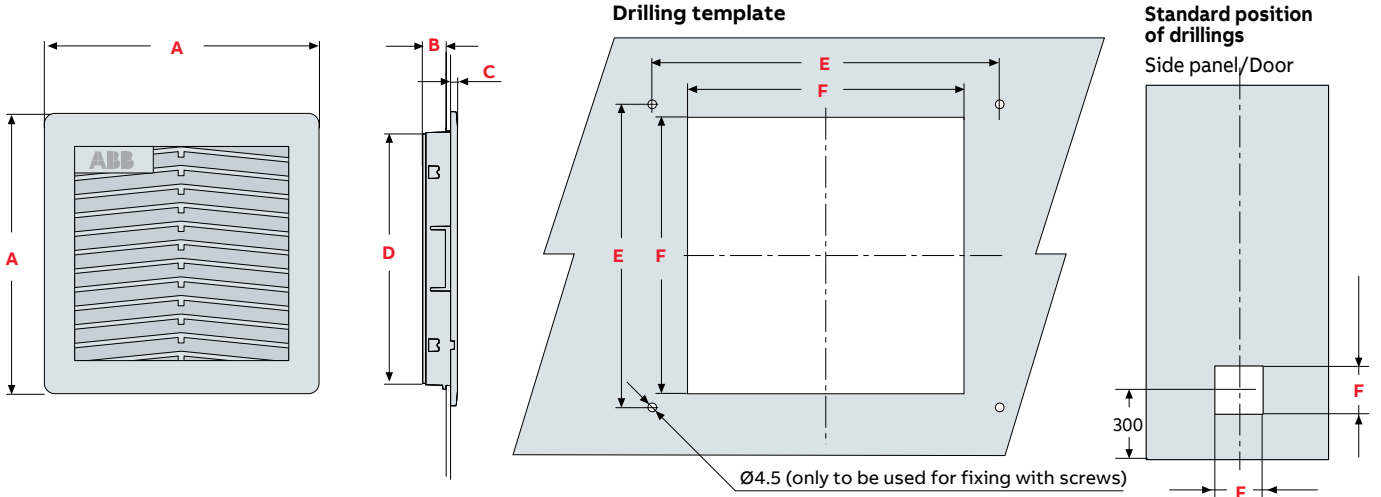

Code	A	B	C	D	E	F
EN0105K	105	60	7	80	95	92
EN0150K	150	64	7	124	131	125
EN0204K	204	90	8	127	185	177
EN0250K	250	113	8	172	230	223
EN0325K	325	24	9	255	302	291

Stainless steel hoods for ventilation kits

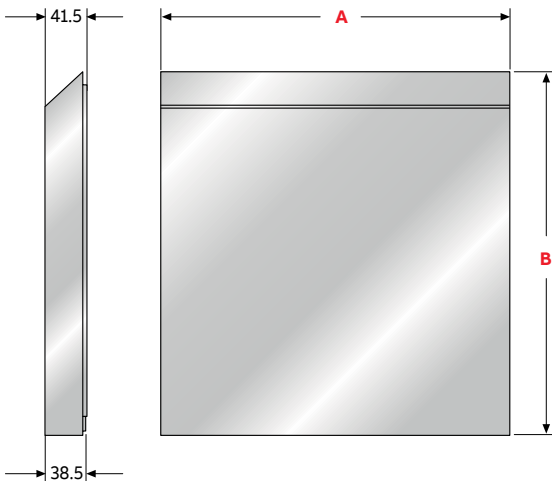

Code	A	B
EN0105X		
EN0150X		
EN0204X		
EN0250X		
EN0325X		

The measurements are given in millimeters

7

Overall dimensions

Natural ventilation/forced ventilation/air conditioning

IP20 heaters

VA7930/VA7950/VA7975

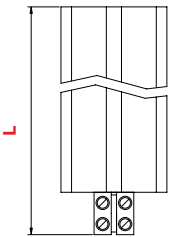
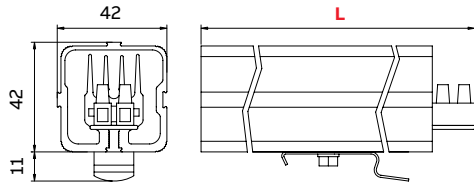

	L (mm)
VA7930	115
VA7950	165
VA7975	210

VA7910

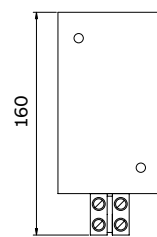
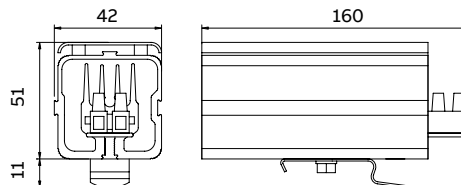

Minimum mounting distances

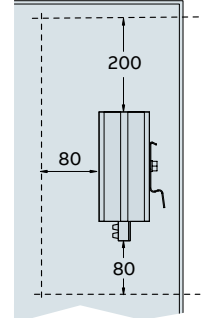

VA7930
VA7950
VA7975

VA7915

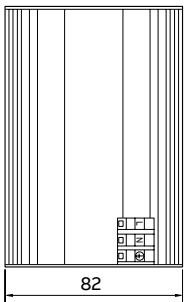
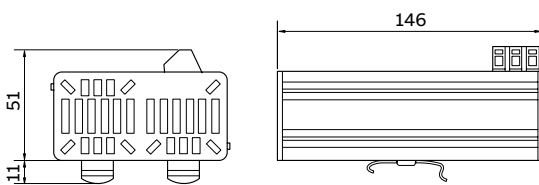

VA8300

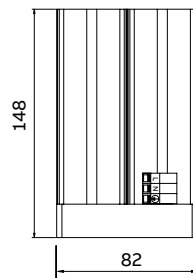
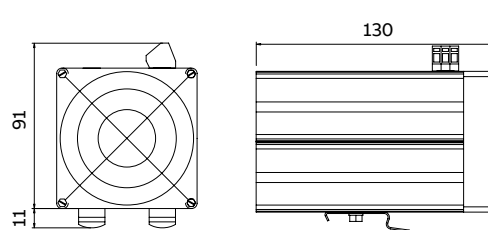

Minimum mounting distances

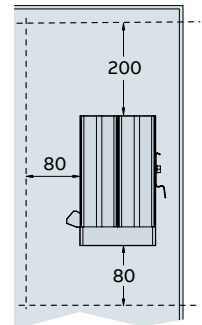

Overall dimensions

Drilling

SRX enclosure drilling

Maximum working dimensions for drilling

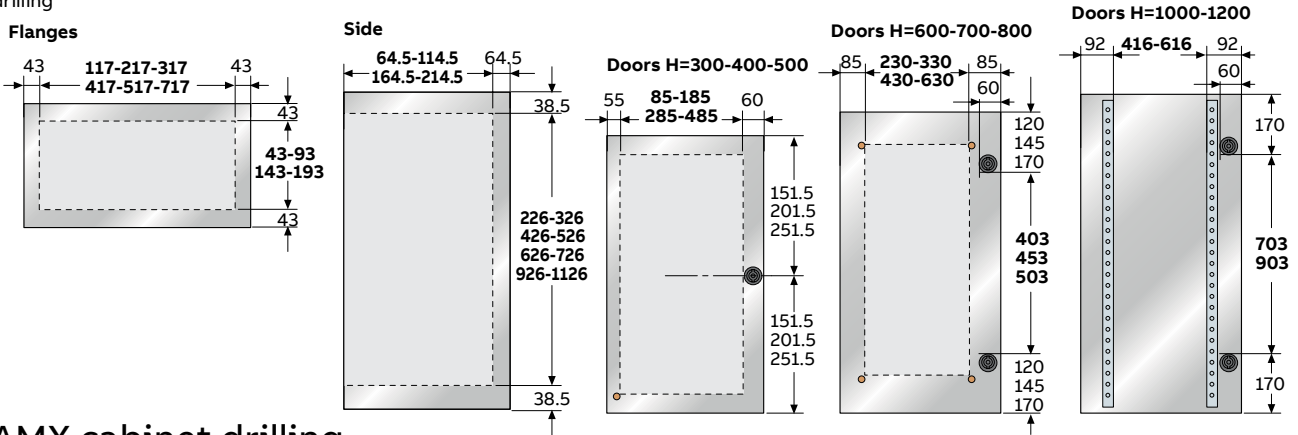

AMX cabinet drilling

Maximum working dimensions for drilling

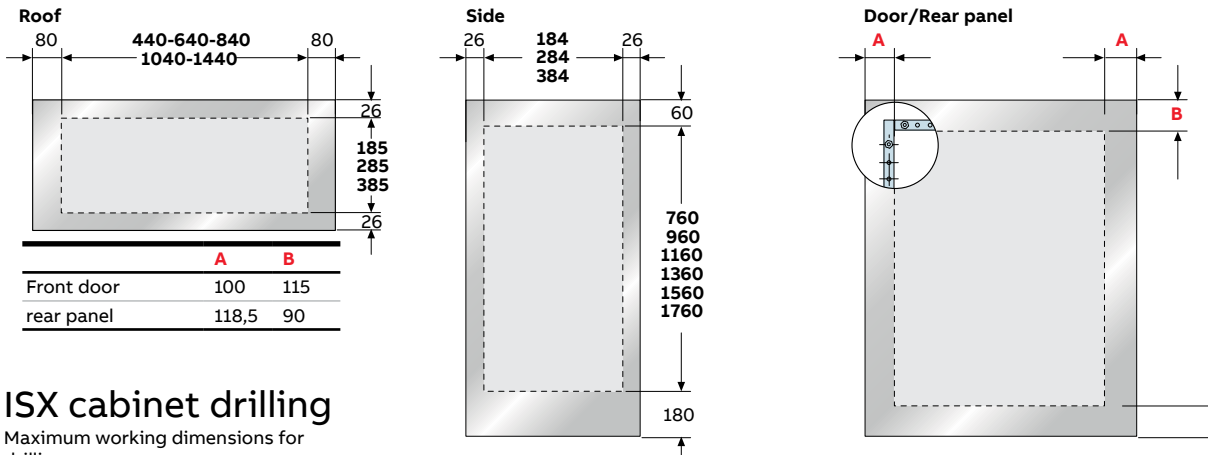

ISX cabinet drilling

Maximum working dimensions for drilling

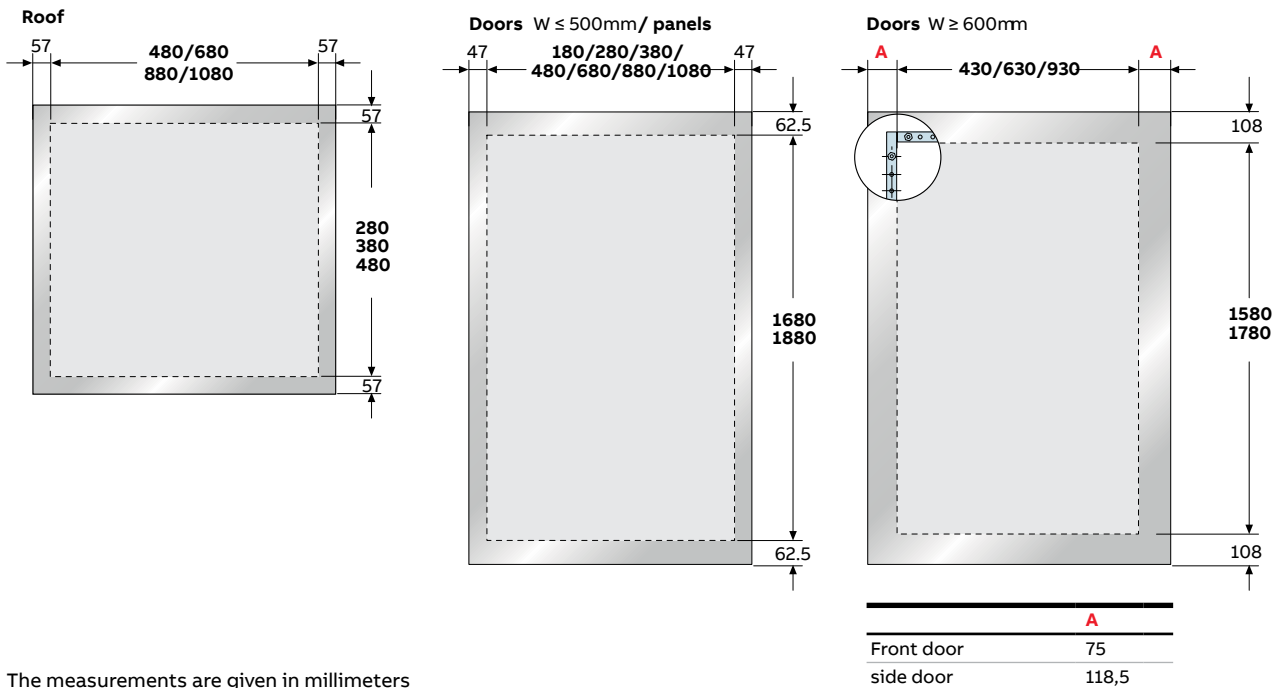

The measurements are given in millimeters

Overall dimensions

Accessories

Aluminium section EV1050

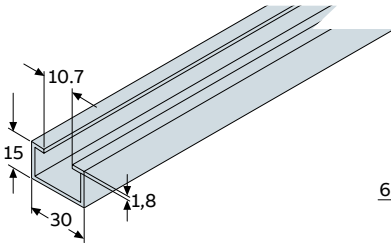

Aluminium nuts for EV1050

EV1056

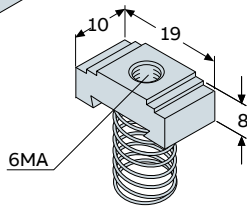

EV1058

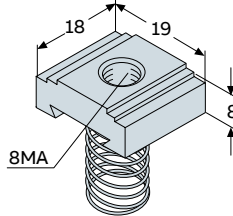

Angles for busbars EV1051

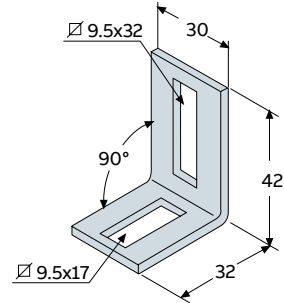

Brackets for cables EV1090 / EV1091

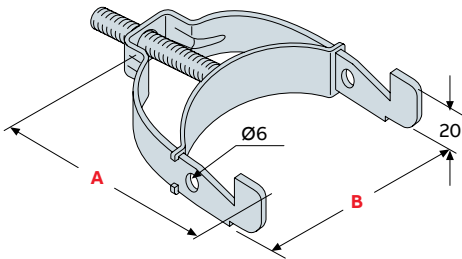

Code	A	B
EV1090	49	20
EV1091	65	36
EV1092	85	51
EV1093	105	80

Terminal box supports

EV1110-EV2110-EV1113

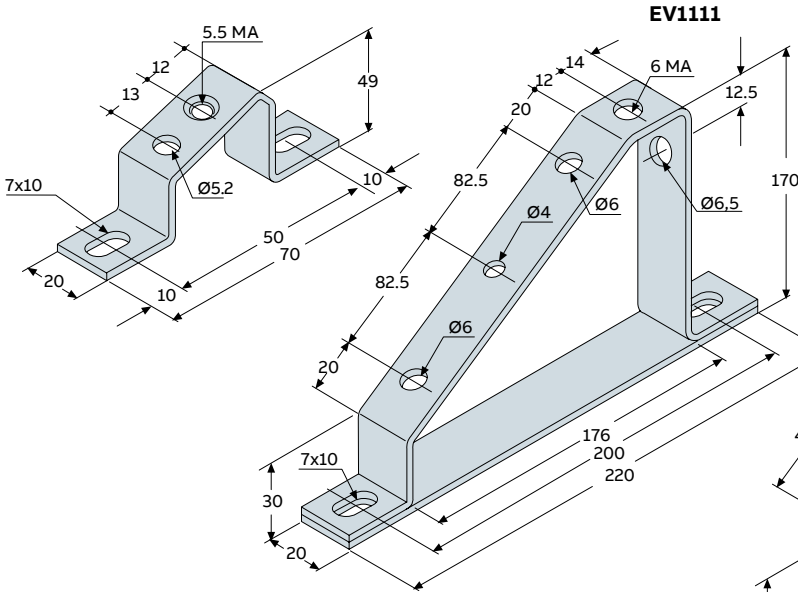

EV1112-EV2112

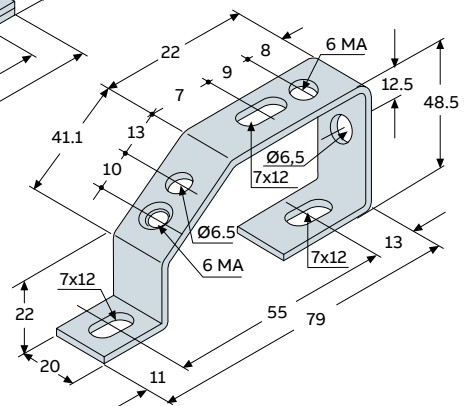

The measurements are given in millimeters

Overall dimensions

Accessories

Voltage indicator

EV1147

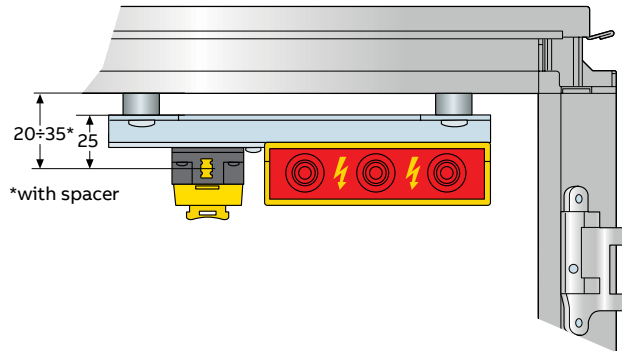

EV1148

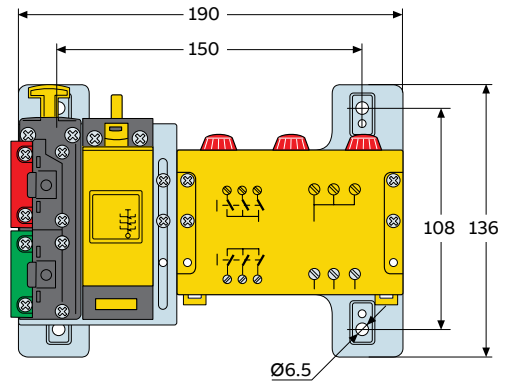
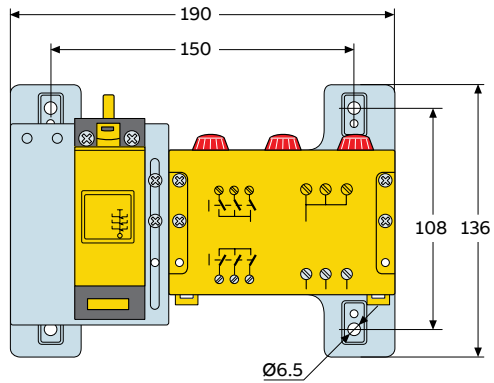
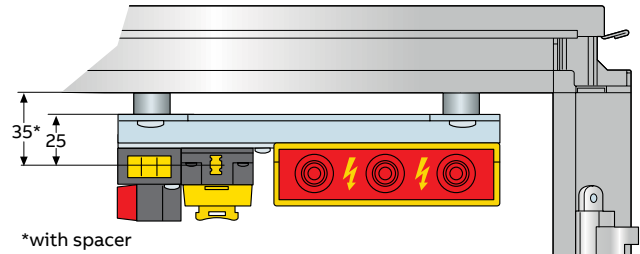

Overall dimensions

Accessories

Fluorescent lights

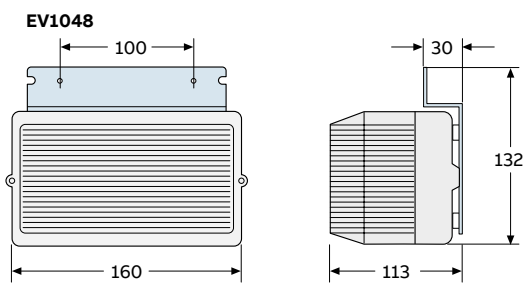
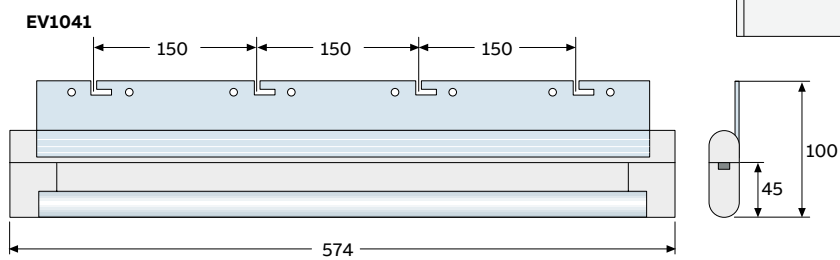
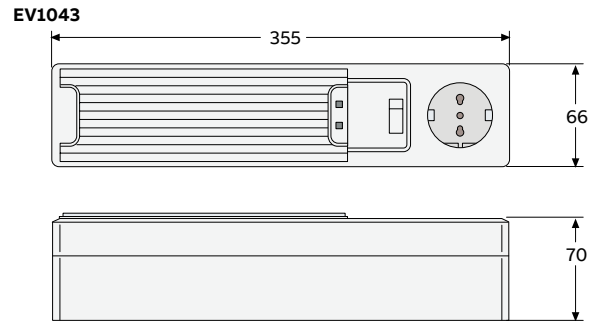
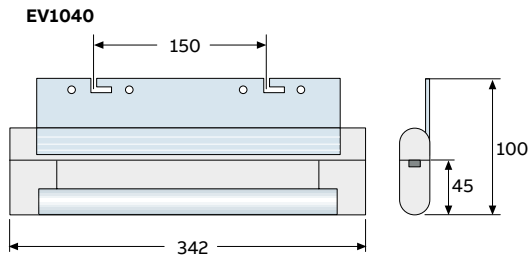

7

Chapter 8

List of codes

8-2 SRX enclosures

8-3 AMX monobloc cabinets

8-5 ISX modular cabinets

8-8 Common accessories to all series

List of codes

SRX enclosure

Code	Page	Weight KG
AA1203X	2-14	0,01
AA1206X	2-9	0,20
AA5190	2-12	0,01
AA5200	2-12	0,01
AA8001X	2-12	0,01
AA8002	2-12	0,01
AA8003	2-12	0,01
AA8025	2-8	0,01
AA8050	2-8	0,01
AP6001	2-12	0,18
EV1008	2-12	0,04
EV1036	2-12	0,04
EV1037	2-12	0,04
EV1039	2-12	0,04
FLN3215X	2-9	0,30
FLN3415X	2-9	0,60
FLN4315X	2-9	0,40
FLN4320X	2-9	0,65
FLN4420X	2-9	0,90
FLN4620X	2-9	1,40
FLN5520X	2-9	1,15
FLN6630X	2-9	1,85
FLN6830X	2-9	2,60
FLN7525X	2-9	1,50
FLN8625X	2-9	2,15
FORSRX	2-13	0,00
GD4006	2-12	0,80
GD6006	2-12	0,90
GD8006	2-12	1,00
GZ4020	2-9	0,05
GZ5020	2-9	0,06
GZ5025	2-9	0,07
GZ6020	2-9	0,07
GZ6025	2-9	0,05
GZ6030	2-9	0,05
GZ8030	2-9	0,05
KC1080X	2-7	14,05
KC4030X	2-7	2,25
KC5040X	2-7	3,75
KC6040X	2-7	4,35
KC7050X	2-7	6,15
KC8060X	2-7	8,45
KD1080X	2-10	2,95
KD5040X	2-10	1,69
KD6040X	2-10	1,80
KD8060X	2-10	2,00
PC1406X	2-11	2,80
PC1606X	2-11	1,29
PC1806X	2-11	1,50
PC2606X	2-11	2,50
PC2806X	2-11	3,00
PF1080	2-7	12,00
PF1260	2-7	11,00
PF1280	2-7	14,50
PF3020	2-7	0,70

Code	Page	Weight KG
PF3040	2-7	1,48
PF4030	2-7	1,48
PF4040	2-7	2,05
PF4060	2-7	3,34
PF5040	2-7	2,62
PF5050	2-7	3,95
PF6040	2-7	3,34
PF6060	2-7	5,10
PF7050	2-7	4,95
PF8060	2-7	6,97
PF8080	2-7	9,40
PM1414X	2-11	2,40
PM1625X	2-11	3,00
PM1836X	2-11	3,70
PRN1086X	2-14	11,50
PRN1266X	2-14	10,00
PRN1286X	2-14	13,00
PRN3026X	2-14	1,00
PRN3046X	2-14	1,70
PRN4036X	2-14	2,10
PRN4046X	2-14	2,61
PRN4066X	2-14	3,50
PRN5046X	2-14	3,00
PRN5056X	2-14	3,42
PRN6046X	2-14	3,50
PRN6066X	2-14	5,00
PRN6086X	2-14	6,20
PRN7056X	2-14	5,00
PRN8066X	2-14	6,20
PRN8086X	2-14	8,50
PS2476X	2-11	1,00
PS2676X	2-11	1,30
PS2876X	2-11	1,80
PTN1086X	2-14	15,00
PTN4036X	2-14	2,10
PTN5046X	2-14	7,00
PTN6046X	2-14	9,00
PTN7056X	2-14	9,00
PTN8066X	2-14	11,00
SRN10830VX	2-6	37,20
SRN10830X	2-6	50,50
SRN12630X	2-6	45,80
SRN12830X	2-6	56,80
SRN3215X	2-6	4,80
SRN3415X	2-6	7,50
SRN4315X	2-6	7,50
SRN4320X	2-6	8,20
SRN4420X	2-6	9,90
SRN4620X	2-6	14,00
SRN5420VX	2-6	9,60
SRN5420X	2-6	11,60
SRN5520X	2-6	12,65
SRN6420VX	2-6	11,50
SRN6420X	2-6	14,00
SRN6620X	2-6	18,50

Code	Page	Weight KG
SRN6630X	2-6	19,40
SRN7525VX	2-6	19,50
SRN7525X	2-6	24,00
SRN8620X	2-6	19,40
SRN8625VX	2-6	23,50
SRN8630X	2-6	22,40
SRN8830X	2-6	41,50
TQ1080	2-8	12,00
TQ1260	2-8	11,00
TQ1280	2-8	14,50
TQ3020	2-8	0,70
TQ3040	2-8	1,50
TQ4030	2-8	1,50
TQ4040	2-8	2,10
TQ4060	2-8	3,50
TQ5040	2-8	2,70
TQ6040	2-8	3,50
TQ6060	2-8	5,50
TQ6610	2-8	0,10
TQ7050	2-8	5,00
TQ8060	2-8	7,00
TQ8080	2-8	9,50
TS6009	2-11	1,00
TS7009	2-11	1,00
TS8009	2-11	1,00
TT2015X	2-12	0,90
TT3015X	2-12	1,00
TT3020X	2-12	1,20
TT4015X	2-12	1,80
TT4020X	2-12	2,00
TT5020X	2-12	2,50
TT5025X	2-12	2,00
TT6020X	2-12	2,70
TT6025X	2-12	2,50
TT6030X	2-12	3,80
TT8030X	2-12	4,50
ZA4020X	2-10	5,26
ZA5020X	2-10	6,58
ZA5025X	2-10	7,32
ZA6020X	2-10	6,57
ZA6030X	2-10	7,87
ZA8030X	2-10	8,94

List of codes

AMX monobloc cabinets

Code	Page	Weight KG	Code	Page	Weight KG	Code	Page	Weight KG
AA1560	3-18	0,02	EA6061	3-11	8,73	EH0029	3-13	1,21
AA1570	3-18	0,03	EA6081	3-11	11,64	EH0036	3-13	0,89
AA6100	3-18	0,01	EA8061	3-11	11,64	EH0562X	3-14	0,37
AA6120	3-18	0,01	EA8081	3-11	15,52	EH0582X	3-14	0,54
AA6140	3-18	0,01	EB0600	3-12	1,32	EH1062X	3-14	0,63
AA6141	3-18	0,02	EB0660	3-12	1,67	EH1082X	3-14	0,87
AA6160	3-18	0,02	EB0800	3-12	1,85	EH1518X	3-14	0,89
AA6180	3-18	0,02	EB0880	3-12	2,36	EH1524X	3-14	0,89
AA6190	3-18	0,02	EB1000	3-12	2,45	EH1529X	3-14	1,23
AA6200	3-18	0,02	EB1010	3-12	4,25	EH1536X	3-14	1,23
AA8001X	3-18	0,01	EB1020	3-12	2,58	EH1562X	3-14	0,89
AA8004	3-18	0,01	EB1041	3-17	0,54	EH1582X	3-14	1,23
AD1009	3-13	0,078	EB1042	3-17	0,86	EH2018X	3-14	1,14
AD1037	3-13	0,34	EB1043	3-17	1,21	EH2024X	3-14	1,14
AD1058	3-18	0,01	EB1200	3-12	3,76	EH2029X	3-14	1,59
AD3301	3-14	0,15	EF1040X	3-9	3,10	EH2036X	3-14	1,59
AD3302	3-14	0,15	EF1044X	3-9	2,42	EH2062X	3-14	1,14
AD3303	3-14	0,15	EF1045X	3-9	3,38	EH2063X	3-15	1,66
AD3304	3-14	0,15	EF1053X	3-9	4,51	EH2065	3-15	1,90
AP6000	3-13	0,01	EF1054X	3-9	3,51	EH2082X	3-14	1,59
EA0018	3-11	2,478	EF1055X	3-9	4,79	EH2083X	3-15	2,21
EA0020	3-11	2,78	EF6040X	3-9	1,61	EH2085	3-15	4,41
EA1061	3-11	11,60	EF6044X	3-9	1,30	EH2272X	3-15	1,14
EA1081	3-11	20,79	EF6045X	3-9	1,76	EH2297X	3-15	1,14
EA1610	3-10	30,54	EF6050X	3-9	2,35	EH2472X	3-15	1,14
EA1612	3-10	36,47	EF6054X	3-9	1,89	EH3018X	3-14	1,66
EA1616	3-10	18,67	EF6055X	3-9	2,49	EH3029X	3-14	2,22
EA1619	3-10	24,60	EF8040X	3-9	2,36	EH3063X	3-14	1,66
EA1810	3-10	35,75	EF8044X	3-9	1,88	EH3064X	3-15	2,49
EA1812	3-10	42,99	EF8045X	3-9	2,57	EH3065	3-15	4,96
EA1860	3-10	200	EF8050X	3-9	3,43	EH3082X	3-14	2,31
EA1880	3-10	25,50	EF8054X	3-9	2,70	EH3083X	3-15	3,32
EA2010	3-10	39,72	EF8055X	3-9	3,64	EH3085	3-15	6,61
EA2013	3-10	47,77	EG1902	3-16	0,41	EH3272X	3-15	1,59
EA2060	3-10	220	EG1903	3-16	0,61	EH3296X	3-15	1,59
EA2062	3-11	2,91	EG1904	3-16	0,82	EH3472X	3-15	1,59
EA2080	3-10	29,90	EG1905	3-16	1,02	EH3496X	3-15	1,59
EA2081	3-11	3,88	EG1906	3-16	1,23	EH4062X	3-14	2,18
EA3061	3-11	4,37	EG1907	3-16	1,43	EH4064X	3-15	3,32
EA3081	3-11	5,82	EG1908	3-16	1,63	EH4065	3-15	6,61
EA4061	3-11	5,82	EG1909	3-16	1,84	EH4082X	3-14	3,04
EA4081	3-11	7,76	EG1910	3-16	2,04	EH4083X	3-15	4,42
EA5011	3-11	31,11	EG1911	3-16	2,24	EH4085	3-15	8,81
EA5022	3-11	37,33	EG1912	3-16	2,45	EH5062X	3-14	2,70
EA5061	3-11	7,28	EG1913	3-16	2,65	EH5063X	3-15	4,15
EA5063	3-11	19,28	EG1914	3-16	2,85	EH5082X	3-14	3,76
EA5081	3-11	9,72	EG1915	3-16	3,06	EH5084X	3-15	5,53
EA5083	3-11	25,99	EG1916	3-16	3,26	EH6018X	3-14	3,22
EA5100	3-10	0,51	EG1917	3-16	3,47	EH6025X	3-14	3,22
EA5616	3-11	15,46	EG1918	3-16	3,67	EH6029X	3-14	4,48
EA5620	3-11	20,61	EG1920	3-16	4,08	EH6036X	3-14	4,48
EA5811	3-11	28,57	EG1991	3-16	0,20	EH6062X	3-14	3,22
EA5822	3-11	34,28	EG1999	3-16	3,88	EH6063X	3-15	4,97
EA5861	3-11	17,36	EH0018	3-13	0,84	EH6082X	3-14	4,48
EA5883	3-11	23,19	EH0024	3-13	0,65	EH6084X	3-15	6,63

List of codes

ISX modular cabinets

Code	Page	Weight KG	Code	Page	Weight KG	Code	Page	Weight KG
AA1560	4-31	0,02	EA1200	4-14	4,89	EB0600	4-19	1,32
AA1570	4-31	0,03	EA1202	4-16	3,34	EB0600	4-19	1,32
AA6100	4-31	0,01	EA1203	4-14	3,06	EB0800	4-19	1,85
AA6120	4-31	0,01	EA1800	4-13	7,17	EB0800	4-19	1,85
AA6140	4-31	0,01	EA1810	4-13	35,75	EB1000	4-19	2,45
AA6141	4-31	0,02	EA1812	4-13	42,99	EB1000	4-19	2,45
AA6160	4-31	0,02	EA1860	4-13	200	EB1041	4-28	0,54
AA6180	4-31	0,02	EA1880	4-13	25,50	EB1042	4-28	0,86
AA6190	4-31	0,02	EA1910	4-16	43,36	EB1043	4-28	1,21
AA6200	4-31	0,02	EA1912	4-16	51,36	EB1200	4-19	3,76
AA8001X	4-31	0,01	EA1960	4-16	27,34	EB1200	4-19	3,76
AA8004	4-31	0,01	EA1981	4-16	35,34	EB4100	4-20	1,72
AA9610	4-28	0,65	EA2000	4-13	7,97	EB4101	4-17	1,90
AD1009	4-20	0,078	EA2010	4-13	39,72	EB5100	4-20	2,16
AD1037	4-20	0,34	EA2013	4-13	47,77	EB5101	4-17	2,53
AD1056	4-29	0,29	EA2060	4-13	220	EB6100	4-20	2,80
AD1058	4-31	0,01	EA2062	4-17	2,91	EB6101	4-17	3,79
AD1064	4-29	0,25	EA2080	4-13	29,90	EB6102	4-20	3,82
AD1065	4-29	0,20	EA2081	4-17	3,88	EB6104	4-25	2,66
AD1066	4-29	0,09	EA2100	4-13	1,04	EB6106	4-25	2,02
AD1067	4-29	0,20	EA2101	4-17	0,27	EB8104	4-25	3,38
AD1068	4-29	1,05	EA2110	4-16	48,17	EB8106	4-25	2,56
AD1069	4-29	2,35	EA2112	4-16	57,06	EE0024	4-23	1,29
AD1077	4-29	1,03	EA2113	4-16	0,14	EE0640	4-27	4,24
AD3301	4-21	0,15	EA2115	4-14	0,12	EE0650	4-27	5,12
AD3302	4-21	0,15	EA2117	4-14	0,47	EE0660	4-27	5,91
AD3303	4-21	0,15	EA2118	4-15	0,48	EE0840	4-27	5,50
AD3304	4-21	0,15	EA2161	4-16	30,38	EE0850	4-27	6,54
AP6000	4-20	0,01	EA2180	4-16	39,26	EE0860	4-27	7,60
BA0400	4-29	3,23	EA3061	4-17	4,37	EE1003K	4-27	5,22
BA0800	4-29	4,41	EA3081	4-17	5,82	EE1004K	4-27	6,39
BA1250	4-29	8,98	EA4061	4-17	5,82	EE1040	4-27	7,37
BA1600	4-29	10,51	EA4081	4-17	7,76	EE1041	4-27	5,02
BF1602	4-30	2,65	EA5011	4-15	31,11	EE1050	4-27	9,29
BF2502	4-30	4,12	EA5022	4-15	37,33	EE1051	4-27	6,19
BF4002	4-30	6,4	EA5061	4-17	7,28	EE1060	4-27	10,86
BF4012	4-30	6,37	EA5063	4-15	19,28	EE1061	4-27	7,36
BF6302	4-30	12,25	EA5081	4-17	9,72	EE1810X	4-10	26,02
BF8002	4-30	18,72	EA5083	4-15	25,99	EE1841	4-26	6,19
BP0630	4-30	0,39	EA5811	4-15	28,57	EE1851	4-26	7,98
BP0632	4-30	0,54	EA5822	4-15	34,28	EE1852	4-23	12,94
BP1250	4-30	7,50	EA5861	4-15	17,36	EE1860X	4-10	17,26
BP1600	4-30	2,55	EA5883	4-15	23,19	EE1861	4-26	9,78
BR0250	4-30	0,10	EA6002	4-16	1,64	EE1862	4-23	15,52
BR0400	4-30	2,74	EA6003	4-14	1,36	EE1880X	4-10	21,64
BR0630	4-30	6,08	EA6061	4-17	8,73	EE1906X	4-10	17,26
EA0018	4-15	2,478	EA6081	4-17	11,64	EE1908X	4-10	21,64
EA0020	4-15	2,78	EA8002	4-16	2,22	EE1910X	4-10	26,02
EA0600	4-14	2,54	EA8003	4-14	1,92	EE2010X	4-10	28,91
EA0802	4-14	3,32	EA8061	4-17	11,64	EE2041	4-26	6,89
EA1000	4-14	4,12	EA8081	4-17	15,52	EE2051	4-26	8,89
EA1002	4-16	2,76	EB0400	4-19	0,94	EE2052	4-23	14,46
EA1003	4-14	2,48	EB0400	4-19	0,94	EE2060X	4-10	19,18
EA1061	4-17	11,60	EB0500	4-19	1,15	EE2061	4-26	10,88
EA1081	4-17	20,79	EB0500	4-19	1,15	EE2062	4-23	17,35

List of codes

ISX modular cabinets

Code	Page	Weight KG	Code	Page	Weight KG	Code	Page	Weight KG
EE2080X	4-10	24,05	EG1909	4-26	1,84	EH3272X	4-22	1,59
EE2100	4-27	5,41	EG1910	4-26	2,04	EH3296X	4-22	1,59
EE2106X	4-10	19,18	EG1911	4-26	2,24	EH3472X	4-22	1,59
EE2108X	4-10	24,04	EG1912	4-26	2,45	EH3496X	4-22	1,59
EE2110X	4-10	28,91	EG1913	4-26	2,65	EH4062X	4-21	2,18
EE2406	4-23	0,61	EG1914	4-26	2,85	EH4064X	4-22	3,32
EE2410	4-23	0,61	EG1915	4-26	3,06	EH4065	4-22	6,61
EE2416	4-23	0,61	EG1916	4-26	3,26	EH4082X	4-21	3,04
EE2600	4-27	3,13	EG1917	4-26	3,47	EH4083X	4-22	4,42
EE2800	4-27	4,31	EG1918	4-26	3,67	EH4085	4-22	8,81
EE6041	4-27	3,12	EG1920	4-26	4,08	EH5062X	4-21	2,70
EE6051	4-27	3,82	EG1991	4-26	0,20	EH5063X	4-22	4,15
EE6061	4-27	4,53	EG1999	4-26	3,88	EH5082X	4-21	3,76
EE8041	4-27	4,07	EG2000	4-24	3,68	EH5084X	4-22	5,53
EE8051	4-27	5,01	EG2001K	4-24	14,80	EH6018X	4-21	3,22
EE8061	4-27	5,95	EG2003K	4-24	180	EH6025X	4-21	3,22
EF1051X	4-11	3,51	EG2005	4-25	7,72	EH6029X	4-21	4,48
EF1052X	4-11	4,79	EG2080	4-24	10,4	EH6036X	4-21	4,48
EF1053X	4-11	4,51	EH0018	4-20	0,84	EH6062X	4-21	3,22
EF1060X	4-11	5,92	EH0024	4-20	0,65	EH6063X	4-22	4,97
EF1061X	4-11	4,71	EH0029	4-20	1,21	EH6082X	4-21	4,48
EF1062X	4-11	6,20	EH0036	4-20	0,89	EH6084X	4-22	6,63
EF6040X	4-11	1,61	EH0562X	4-21	0,37	EL1840X	4-9	18,24
EF6041X	4-11	1,30	EH0582X	4-21	0,54	EL1850X	4-9	22,91
EF6043X	4-11	1,76	EH1062X	4-21	0,63	EL1860X	4-9	27,58
EF6050X	4-11	2,35	EH1082X	4-21	0,87	EL2050X	4-9	25,46
EF6051X	4-11	1,89	EH1518X	4-21	0,89	EL2060X	4-9	30,64
EF6052X	4-11	2,49	EH1524X	4-21	0,89	EM1804	4-24	5,86
EF6060X	4-11	3,08	EH1529X	4-21	1,23	EM2004	4-24	6,55
EF6061X	4-11	2,52	EH1536X	4-21	1,23	ES1805VX	4-8	95,79
EF6062X	4-11	3,22	EH1562X	4-21	0,89	ES1805X	4-8	100,27
EF8040X	4-11	2,36	EH1582X	4-21	1,23	ES1806VX	4-8	99,25
EF8041X	4-11	1,88	EH1800	4-20	3,50	ES1806X	4-8	103,74
EF8042X	4-11	2,57	EH2000	4-20	4,26	ES1826BX	4-8	130,70
EF8050X	4-11	3,43	EH2018X	4-21	1,14	ES1827BX	4-8	126,74
EF8051X	4-11	2,70	EH2024X	4-21	1,14	ES1864VX	4-8	66,43
EF8052X	4-11	3,64	EH2029X	4-21	1,59	ES1864X	4-8	680
EF8060X	4-11	4,50	EH2036X	4-21	1,59	ES1865VX	4-8	66,95
EF8061X	4-11	3,63	EH2062X	4-21	1,14	ES1865X	4-8	71,66
EF8062X	4-11	4,71	EH2063X	4-22	1,66	ES1884VX	4-8	79,37
EG0500K	4-25	3,92	EH2065	4-22	1,90	ES1884X	4-8	820
EG0900K	4-25	4,70	EH2082X	4-21	1,59	ES1885VX	4-8	78,36
EG1300K	4-25	6,79	EH2083X	4-22	2,21	ES1885X	4-8	85,96
EG1800	4-24	3,31	EH2085	4-22	4,41	ES2005VX	4-8	105,37
EG1801K	4-24	13,32	EH2272X	4-22	1,14	ES2006VX	4-8	109,18
EG1803K	4-24	16,05	EH2297X	4-22	1,14	ES2006X	4-8	111,05
EG1805	4-25	6,98	EH2472X	4-22	1,14	ES2007X	4-8	107,58
EG1880	4-24	9,31	EH3018X	4-21	1,66	ES2025BX	4-8	135,98
EG1902	4-26	0,41	EH3029X	4-21	2,22	ES2026BX	4-8	139,95
EG1903	4-26	0,61	EH3063X	4-21	1,66	ES2065VX	4-8	75,84
EG1904	4-26	0,82	EH3064X	4-22	2,49	ES2065X	4-8	76,68
EG1905	4-26	1,02	EH3065	4-22	4,96	ES2066VX	4-8	78,61
EG1906	4-26	1,23	EH3082X	4-21	2,31	ES2066X	4-8	79,20
EG1907	4-26	1,43	EH3083X	4-22	3,32	ES2085VX	4-8	90,61
EG1908	4-26	1,63	EH3085	4-22	6,61	ES2085X	4-8	92,13

List of codes

ISX modular cabinets

Code	Page	Weight KG	Code	Page	Weight KG	Code	Page	Weight KG
ES2086VX	4-8	93,90	TP8040X	4-11	7,59			
ES2086X	4-8	95,12	TP8050X	4-11	8,96			
EV0002X	4-12	1,74	TP8060X	4-11	11,95			
EV0003X	4-12	0,23	TT1806X	4-32	16,41			
EV0005	4-28	0,20	TT1808X	4-32	21,25			
EV0006X	4-12	1,12	TT1810X	4-32	26,48			
EV1007	4-28	2,70	TT2006X	4-32	18,20			
EV1008	4-31	0,04	TT2008X	4-32	23,98			
EV1030	4-31	0,29	TT2010X	4-32	30,72			
EV1036	4-31	0,03	TU1000X	4-10	5,88			
EV1037	4-31	0,03	ZN1000X	4-9	3,17			
EV1039	4-31	0,03	ZN1010X	4-9	3,54			
EV1060K	4-28	1,59	ZN4001X	4-9	0,60			
EV1061K	4-28	2,34	ZN5001X	4-9	0,87			
EV1160	4-28	0,84	ZN6000X	4-9	1,89			
EX1860	4-18	21,13	ZN6000X	4-9	1,89			
EX1880	4-18	29,58	ZN8000X	4-9	2,53			
EX2060	4-18	23,48	TE2060X	4-32				
EX2080	4-18	32,87	TE2080X	4-32				
GD1520	4-18	0,78	TE2010X	4-32				
GD1530	4-18	1,75	TE2012X	4-32				
PB0803	4-29	0,39						
PB1603	4-29	1,09						
PIRH0405	4-31	0,2						
PIRH0455	4-31	0,2						
PIRH1242	4-31	0,2						
PIRH2432	4-31	0,2						
TC1606X	4-32	13,29						
TC1608X	4-32	17,50						
TC1806X	4-32	14,92						
TC1808X	4-32	19,65						
TC1810X	4-32	25,17						
TC1812DX	4-32	14,92						
TC1812SX	4-32	16,03						
TC2006X	4-32	16,55						
TC2008X	4-32	21,80						
TC2010X	4-32	27,69						
TC2012DX	4-32	16,55						
TC2012SX	4-32	17,83						
TE1660X	4-32	13,50						
TE1680X	4-32	17,74						
TE1810X	4-32	24,66						
TE1812X	4-32	29,41						
TE1860X	4-32	15,16						
TE1880X	4-32	19,91						
TE2010X	4-32	27,35						
TE2012X	4-32	32,62						
TE2060X	4-32	16,81						
TE2080X	4-32	22,08						
TP1050X	4-11	10,62						
TP1060X	4-11	12,75						
TP1250X	4-11	12,26						
TP1260X	4-11	14,71						
TP6040X	4-11	6,18						
TP6050X	4-11	7,31						

List of codes

Common accessories to all series

Code	Page	Weight KG	Code	Page	Weight KG	Code	Page	Weight KG
AA6840	5-10	0,01	EV1071K	5-9	1,54	VA7915	5-6	0,55
AA6850	5-10	0,01	EV1072K	5-9	2,06	VA7930	5-6	0,30
AA6880	5-10	0,01	EV1073K	5-9	2,57	VA7950	5-6	0,35
AA6890	5-10	0,57	EV1075K	5-9	0,2	VA7975	5-6	0,45
AD1004	5-5	0,54	EV1090	5-10	0,46	VA8300	5-6	0,80
AD1027	5-5	0,69	EV1091	5-10	0,86			
AD1028	5-5	0,31	EV1092	5-10	0,54			
AD1029	5-5	0,41	EV1093	5-10	0,54			
AD1033	5-3	0,22	EV1100	5-3	1,13			
AD1036	5-3	0,07	EV1101	5-3	1,25			
AD1086	5-2	3,44	EV1110	5-9	2,69			
AD1088	5-2	1,38	EV1111	5-9	0,67			
AD1089	5-2	2,04	EV1112	5-9	2,69			
AD1101	5-2	0,04	EV1113	5-9	0,12			
AD1102	5-2	0,02	EV1115	5-10	0,64			
AD1103	5-2	0,02	EV1116	5-10	0,74			
AD1104	5-2	0,02	EV1117	5-10	0,65			
AD1600	5-2	0,24	EV1118	5-10	0,94			
AD1800	5-2	0,35	EV1119	5-10	3,53			
EH2118	5-2	0,06	EV1120	5-10	4,41			
EH2129	5-2	0,08	EV1121	5-10	8,67			
EN0101K	5-3	0,07	EV1122	5-10	2,4			
EN0102K	5-3	0,05	EV1123	5-10	2,44			
EN0105K	5-11	0,09	EV1124	5-10	2,71			
EN0105X	5-11	0,09	EV1125	5-10	2,71			
EN0150K	5-11	0,18	EV1130	5-3	1,04			
EN0150X	5-11	0,18	EV1131	5-3	5,77			
EN0204K	5-11	0,3	EV1135	5-2	0,23			
EN0204X	5-11	0,3	EV1136	5-2	0,16			
EN0250K	5-11	0,51	EV1137	5-2	0,23			
EN0250X	5-11	0,51	EV1140	5-9	0,18			
EN0325K	5-11	0,98	EV1143	5-8	0,07			
EN0325X	5-11	0,98	EV1144	5-8	0,07			
EN1105K	5-12	0,42	EV1145	5-8	0,07			
EN1150K	5-12	0,86	EV1146	5-8	0,02			
EN1204K	5-12	0,99	EV1147	5-8	0,36			
EN1250K	5-12	1,62	EV1148	5-8	0,35			
EN2105K	5-12	0,42	EV1150	5-3	0,09			
EN2150K	5-12	0,86	EV1151	5-3	0,09			
EN2204K	5-12	0,99	EV1152	5-3	0,09			
EN2250K	5-12	1,62	EV1153	5-3	0,09			
EN2325K	5-12	3,63	EV1154	5-3	0,09			
EN3325K	5-12	3,63	EV1155	5-3	0,01			
EV1040	5-7	0,37	EV1156	5-3	0,06			
EV1041	5-7	1,08	EV2110	5-9	0,55			
EV1042	5-7	0,24	EV2112	5-9	0,55			
EV1043	5-7	0,73	FORAMX	5-12				
EV1044	5-7	0,11	FORISX	5-12				
EV1045	5-7	0,24	FORSRX	5-12				
EV1047	5-7	0,48	TA7100	5-9	0,15			
EV1048	5-7	0,53	TS0060	5-9	1,67			
EV1050	5-10	6,74	TS0080	5-9	2,24			
EV1051	5-10	0,9	TS0100	5-9	2,80			
EV1056	5-10	0,31	TS0120	5-9	3,37			
EV1058	5-10	0,49	VA7910	5-6	0,40			



ABB SACE

Electrification Products Division

Protection & Connection

58, Via Italia

I-23846 Garbagnate Monastero (LC)

Phone: +39 031 3570.111

Fax: +39 031 3570.228

www.abb.com