



Our Focus is in Plastics

Polymer Optics Ltd.

6 Kiln Ride, Wokingham, Berks.,
 RG40 3JL, England
 Tel/Fax: +44 (0) 1189 893341
 www.polymer-optics.co.uk

6 Degree LED Collimator Lens - Part No. 120



- Designed to operate with Osram “Golden Dragon” LEDs
- Can also be used with the latest Dragon Plus and Platinum Dragon LED packages from Osram
- High light collection efficiency of >85%
- Precision moulded in optical grade Polycarbonate for thermal stability and system durability
- Part of the Polymer Optics “Modular LED Optics”® range

Polymer Optics “Modular LED Optics”® design, based on a hexagonal format, allows maximum packing density and assembly flexibility

Supplied with Holder (Part No. 127) to mount optics directly on to PCB's. Holder locates on LED package to ensure correct alignment

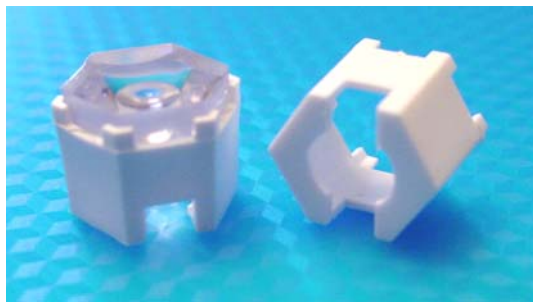

Typical dimensional tolerances to +/- 0.2mm

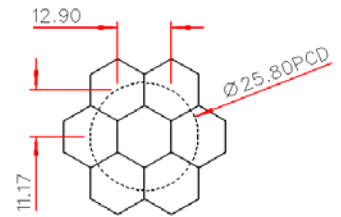
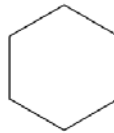

NESTED COMPONENTS ON 25,8MM PCD (HALF SIZE)

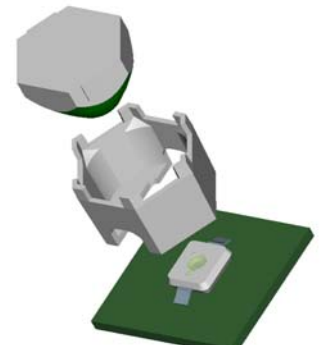
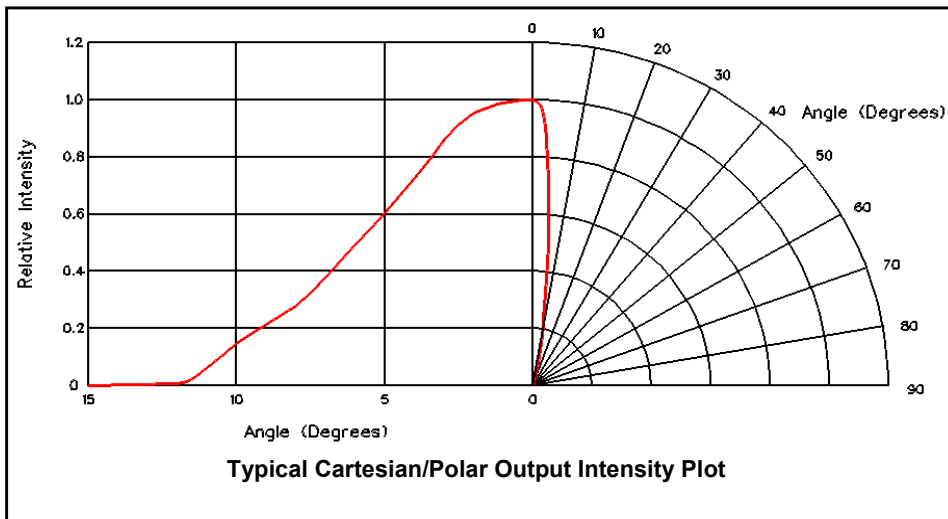
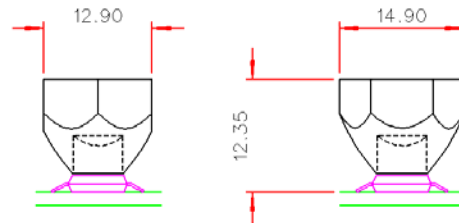

Due to continuous product improvement, POL reserve the right to change specifications without notice.



Our Focus is in Plastics

Polymer Optics Ltd.

6 Kiln Ride, Wokingham, Berks.,
 RG40 3JL, England
 Tel/Fax: +44 (0) 1189 893341
 www.polymer-optics.co.uk

15 Degree LED Collimator Lens - Part No. 124



- Designed to operate with Osram “Golden Dragon” LEDs
- Can also be used with the latest Dragon Plus and Platinum Dragon LED packages from Osram
- High light collection efficiency of >85%
- Precision moulded in optical grade Polycarbonate for thermal stability and system durability
- Part of the Polymer Optics “Modular LED Optics”® range

Polymer Optics “Modular LED Optics”® design, based on a hexagonal format, allows maximum packing density and assembly flexibility

Supplied with Holder (Part No. 127) to mount optics directly on to PCB's. Holder locates on LED package to ensure correct alignment

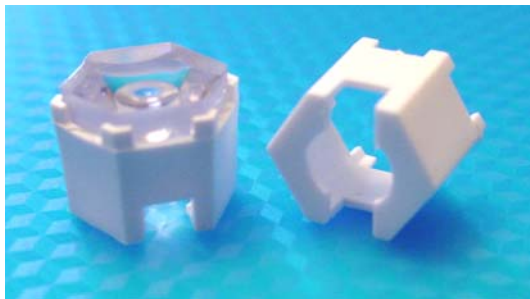

Typical dimensional tolerances to +/- 0.2mm

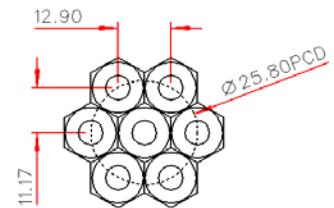
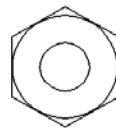

NESTED COMPONENTS ON 25,8MM PCD (shown half size)

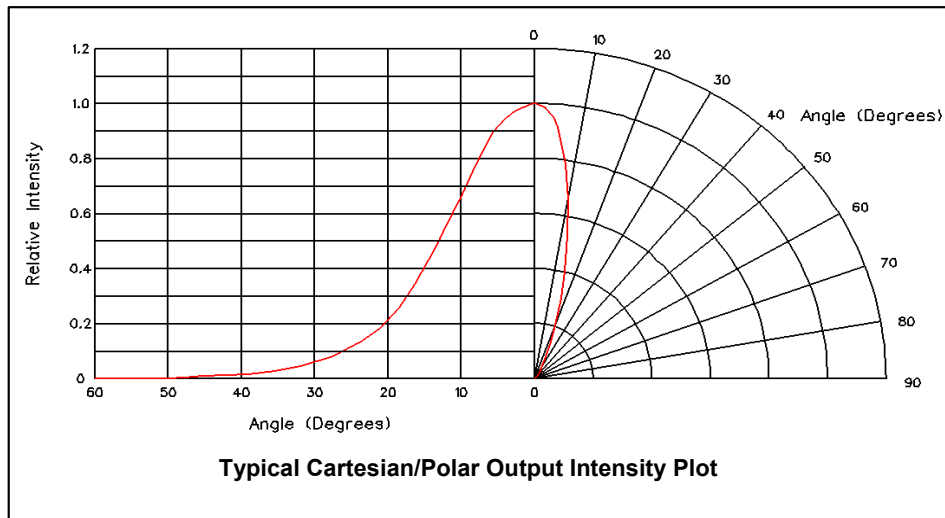
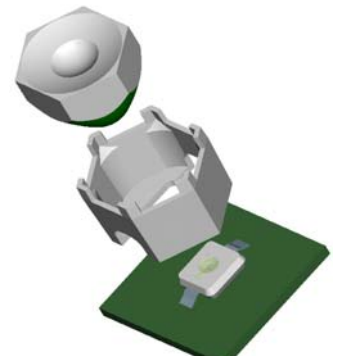
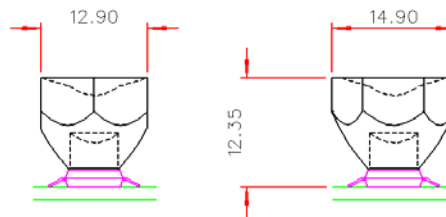

Due to continuous product improvement, POL reserve the right to change specifications without notice.



Our Focus is in Plastics

Polymer Optics Ltd.

6 Kiln Ride, Wokingham, Berks.,
 RG40 3JL, England
 Tel/Fax: +44 (0) 1189 893341
 www.polymer-optics.co.uk

6x15 Degree LED Line Lens - Part No. 126

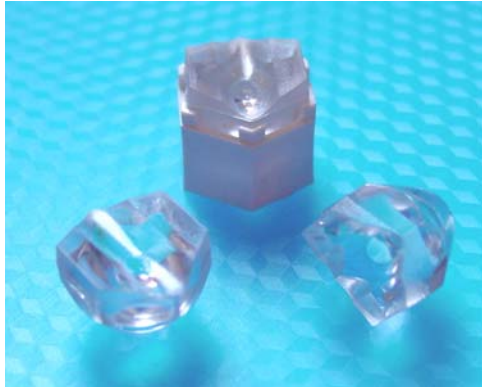

- Designed to operate with Osram “Golden Dragon” LEDs
- Can also be used with the latest Dragon Plus and Platinum Dragon LED packages from Osram
- High light collection efficiency of >85%
- Precision moulded in optical grade Polycarbonate for thermal stability and system durability
- Part of the Polymer Optics “Modular LED Optics”® range

Typical dimensional tolerances to +/- 0.2mm

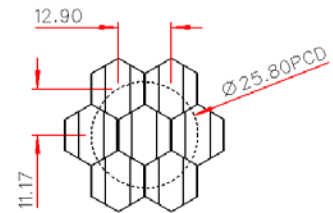
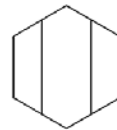

NESTED COMPONENTS ON 25.8MM PCD (shown half size)

Polymer Optics “Modular LED Optics”® design, based on a hexagonal format, allows maximum packing density and assembly flexibility

Supplied with Holder (Part No. 127) to mount optics directly on to PCB's. Holder locates on LED package to ensure correct alignment

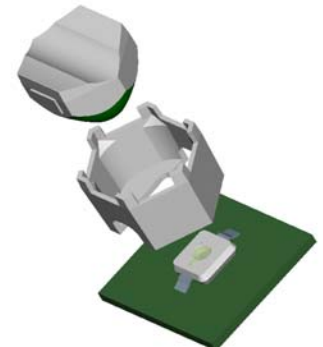
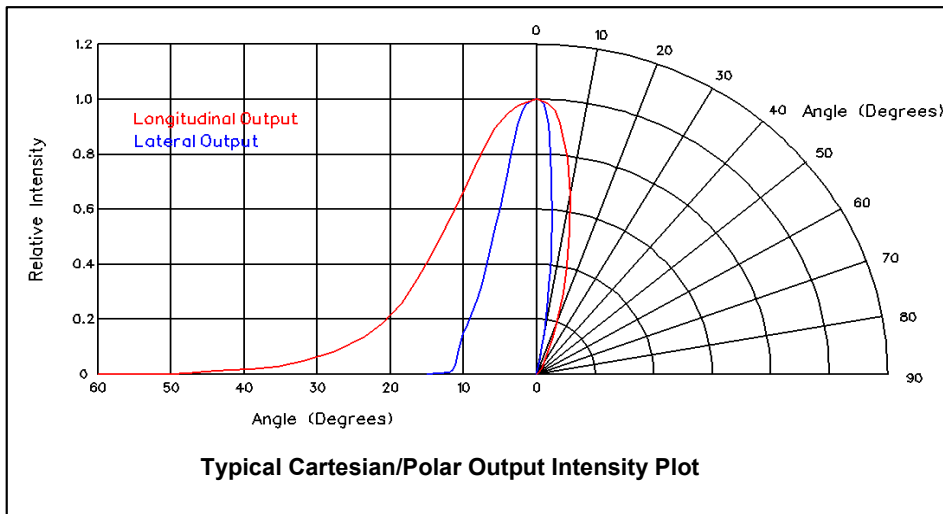
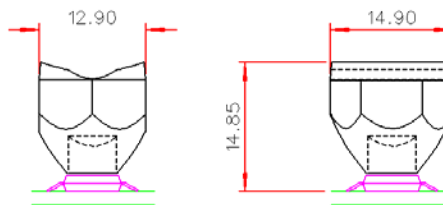

Due to continuous product improvement, POL reserve the right to change specifications without notice.

© Copyright Polymer Optics Limited 2008



Our Focus is in Plastics

Polymer Optics Ltd.

6 Kiln Ride, Wokingham, Berks.,
 RG40 3JL, England
 Tel/Fax: +44 (0) 1189 893341
 www.polymer-optics.co.uk

Osram Dragon LED Lens Holder - Part No. 127

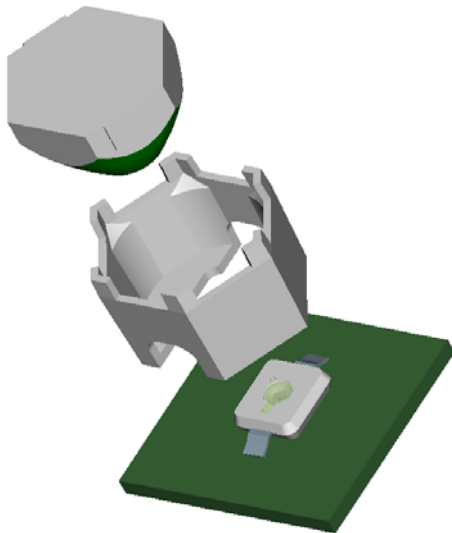

- Designed for use with Polymer Optics “Modular LED Optics”[®] and custom Polymer Optics designs
- Designed for use with Osram “Golden Dragon” LEDs
- Can also be used with the latest Dragon Plus and Platinum Dragon LED packages from Osram
- Simply mounts onto PCB and self-aligns to Dragon emitter
- Precision moulded in optical grade Polycarbonate for thermal stability and system durability
- Part of the Polymer Optics “Modular LED Optics”[®] range

Polymer Optics “Modular LED Optics”[®] design, based on a hexagonal format, allows maximum packing density and assembly flexibility

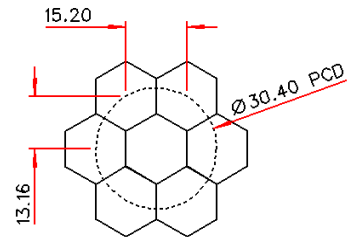
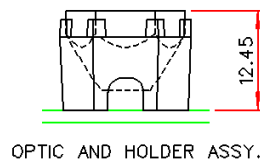
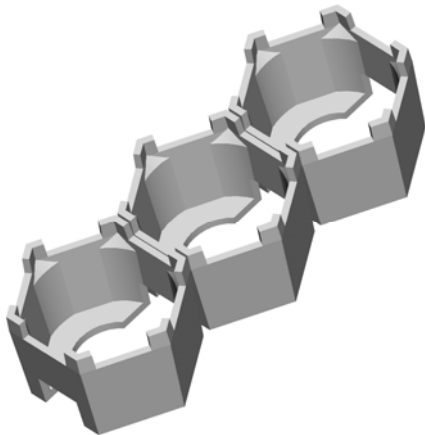

NESTED COMPONENTS ON 30.4MM PCD
 Typical dimensional tolerances to +/-0.2mm

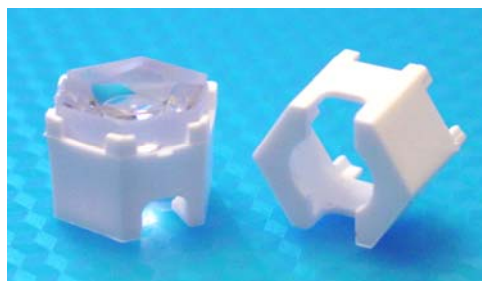
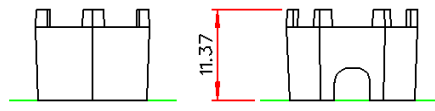
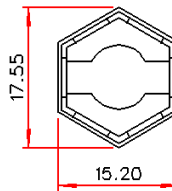

Due to continuous product improvement, POL reserve the right to change specifications without notice.



Our Focus is in Plastics

Polymer Optics Ltd.

6 Kiln Ride, Wokingham, Berks.,
 RG40 3JL, England
 Tel/Fax: +44 (0) 1189 893341
 www.polymer-optics.co.uk

6 Degree LED Collimator 7 Cell Cluster Optic - Part No. 134

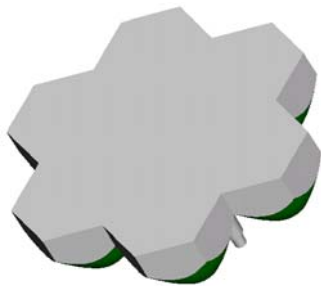
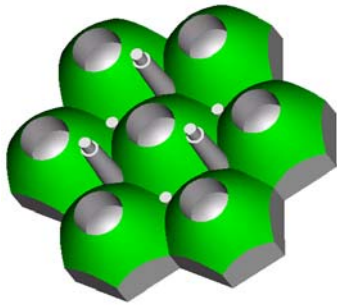

- Designed to operate with Osram “Golden Dragon” LEDs
- Can also be used with the latest Dragon Plus and Platinum Dragon LED packages from Osram
- High light collection efficiency of >85%
- Precision moulded in optical grade Polycarbonate for thermal stability and system durability
- Part of the Polymer Optics “Modular LED Optics”® range

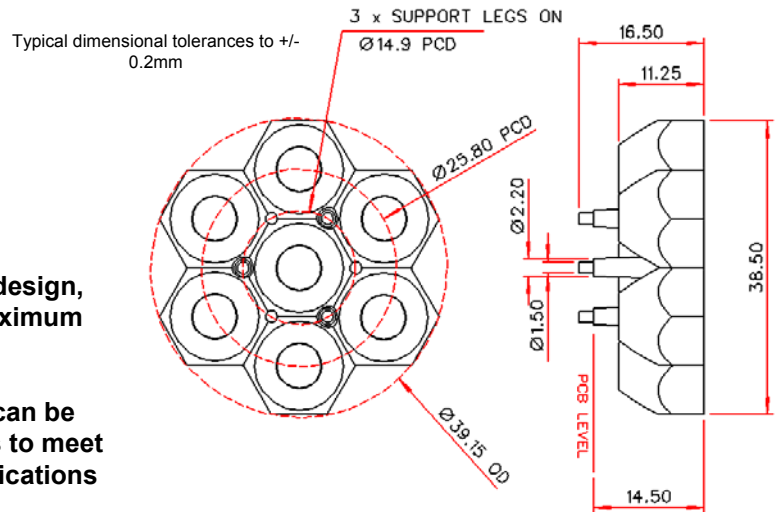

Polymer Optics “Modular LED Optics”® design, based on a hexagonal format, allows maximum packing density and assembly flexibility

Polymer Optics “Cluster Optic”® arrays can be assembled together in a number of ways to meet the needs of a range of illumination applications

The 134 and 135 type “Cluster Optics”® can be mixed in the assembly to optimise the systems illumination distribution, and combined with other Polymer Optics custom cluster designs.

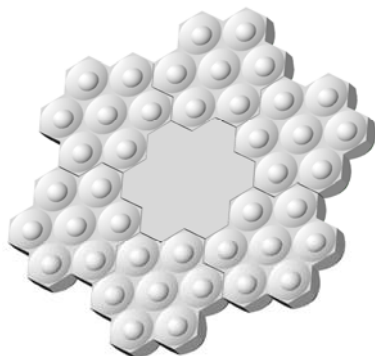

Output beam is rendered homogeneous within only 100mm from front of optic

This gives excellent colour mixing with RGB LED mixes



Due to continuous product improvement, POL reserve the right to change specifications without notice.



Our Focus is in Plastics

Polymer Optics Ltd.

6 Kiln Ride, Wokingham, Berks.,
 RG40 3JL, England
 Tel/Fax: +44 (0) 1189 893341
 www.polymer-optics.co.uk

15 Degree LED Collimator 7 Cell Cluster Optic - Part No. 135

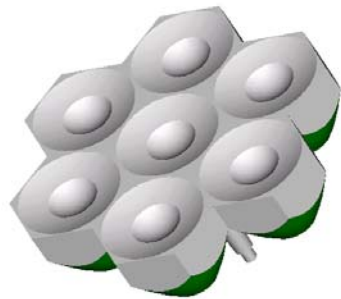
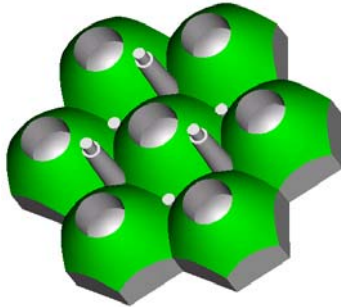

- Designed to operate with Osram “Golden Dragon” LEDs
- Can also be used with the latest Dragon Plus and Platinum Dragon LED packages from Osram
- High light collection efficiency of >85%
- Precision moulded in optical grade Polycarbonate for thermal stability and system durability
- Part of the Polymer Optics “Modular LED Optics”® range

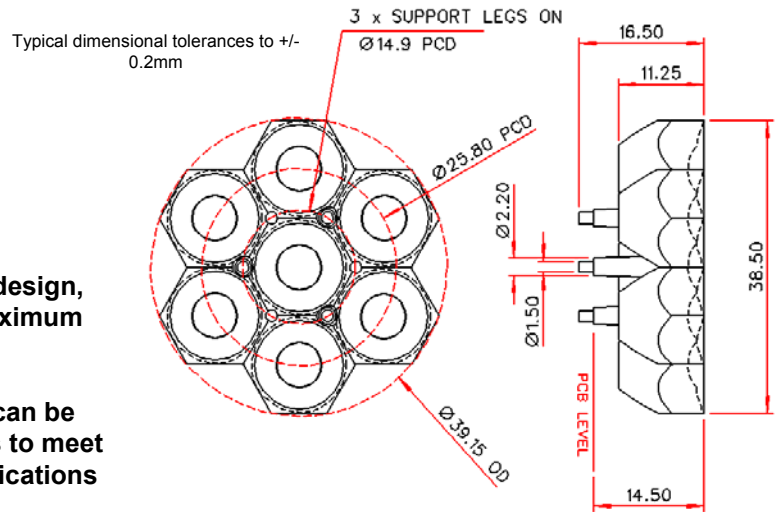

Polymer Optics “Modular LED Optics”® design, based on a hexagonal format, allows maximum packing density and assembly flexibility

Polymer Optics “Cluster Optic”® arrays can be assembled together in a number of ways to meet the needs of a range of illumination applications

The 134 and 135 type “Cluster Optics”® can be mixed in the assembly to optimise the systems illumination distribution, and combined with other Polymer Optics custom cluster designs.

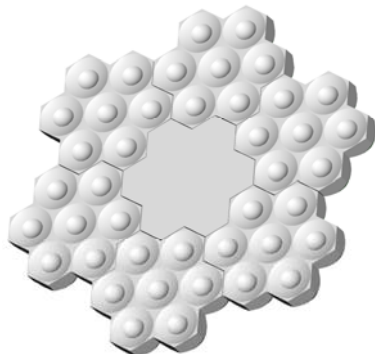

Output beam is rendered homogeneous within only 100mm from front of optic

This gives excellent colour mixing with RGB LED mixes

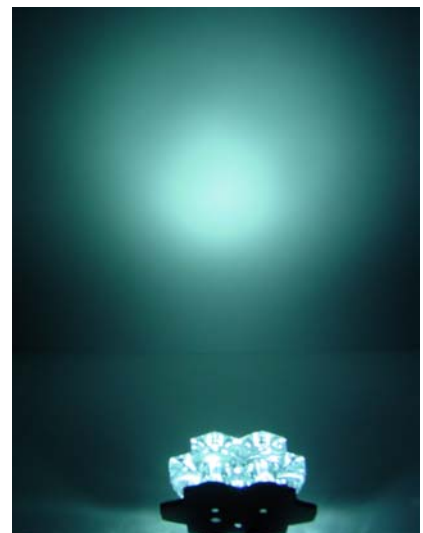

Due to continuous product improvement, POL reserve the right to change specifications without notice.



Our Focus is in Plastics

Polymer Optics Ltd.

6 Kiln Ride, Wokingham, Berks.,
 RG40 3JL, England
 Tel/Fax: +44 (0) 1189 893341
 www.polymer-optics.co.uk

7 Cell Cluster Zoom Optic - Part No. 130

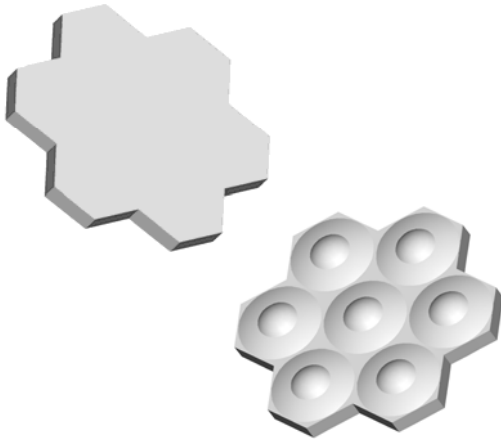

- Designed to operate with Osram “Golden Dragon” LEDs
- Can also be used with the latest Dragon Plus and Platinum Dragon LED packages from Osram
- Variable zoom capability from 6 degrees to 45 degree half angles (Patent applied for design and concept)
- Used with Part No. 135. Zoom optic simply requires to be moved forward and rotated on a coarse thread action.
- Precision moulded in optical grade Polycarbonate for thermal stability and system durability
- Part of the Polymer Optics “Modular LED Optics”® range

ROTATE ZOOM OPTIC BY 30°

Typical dimensional tolerances to +/-0.2mm

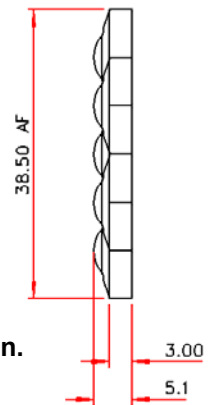
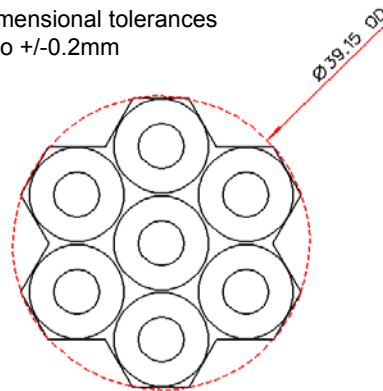
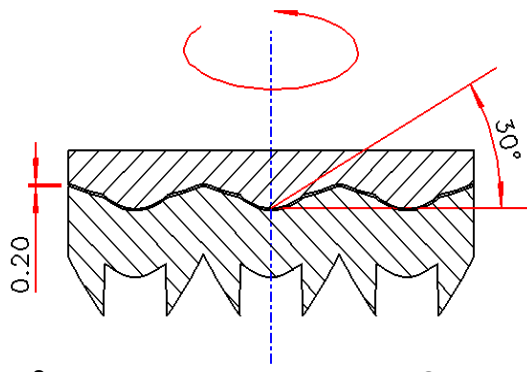

Initial 6° beam is achieved with Zoom Optic nested on Part No. 135 with 0- 0.2mm separation. Rotate Zoom Optic about its axis on a thread angle of 30° by only 30° to achieve 45° beam. Thread pitch equates to 45mm per turn, or 0.6 turns per inch.



6° Position



Mid Position



Wide Angle Position

Due to continuous product improvement, POL reserve the right to change specifications without notice.



Our Focus is in Plastics

Polymer Optics Ltd.

6 Kiln Ride, Wokingham, Berks.,
 RG40 3JL, England
 Tel/Fax: +44 (0) 1189 893341
 www.polymer-optics.co.uk

7 Cell Cluster Concentrator Optic - Part No. 145

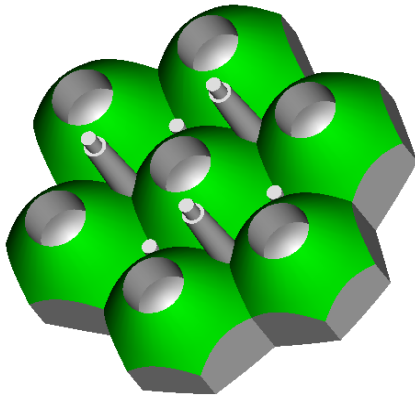

- Designed to operate with Osram “Golden Dragon” LEDs
- Can also be used with the latest Dragon Plus and Platinum Dragon LED packages from Osram
- High light collection efficiency of >85%
- Precision moulded in optical grade Polycarbonate for thermal stability and system durability
- Part of the Polymer Optics “Modular LED Optics”® range

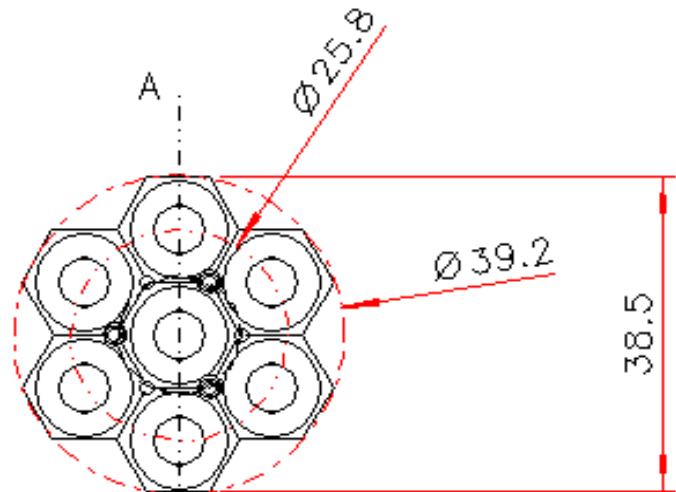
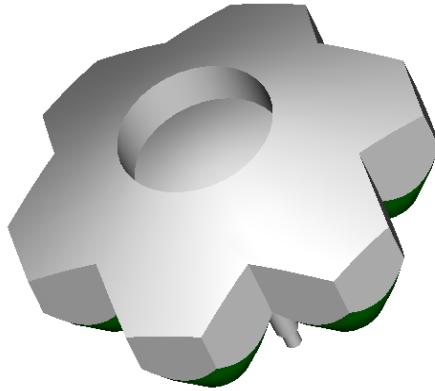

Typical dimensional tolerances to +/- 0.2mm

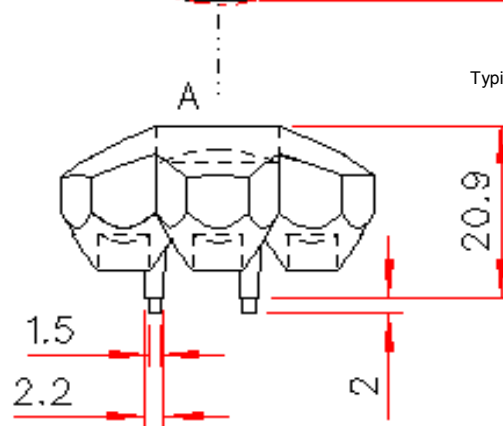

Polymer Optics “Modular LED Optics”® design, based on a hexagonal format, allows maximum packing density and assembly flexibility

Due to continuous product improvement, POL reserve the right to change specifications without notice.



Our Focus is in Plastics

Polymer Optics Ltd.

6 Kiln Ride, Wokingham, Berks.,
 RG40 3JL, England
 Tel/Fax: +44 (0) 1189 893341
 www.polymer-optics.co.uk

7 Cell Cluster Concentrator Optic - Part No. 145

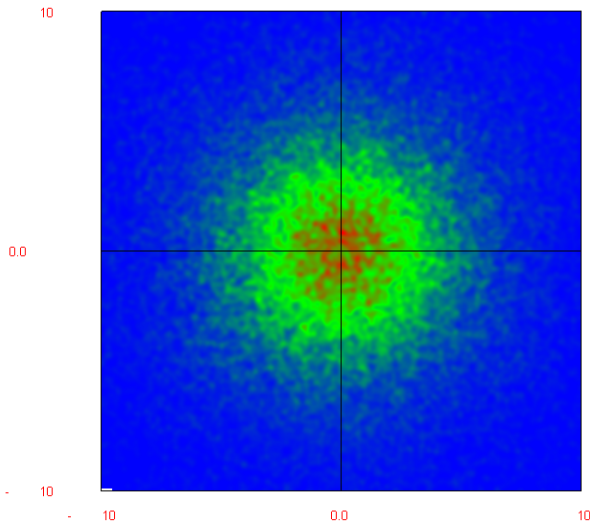
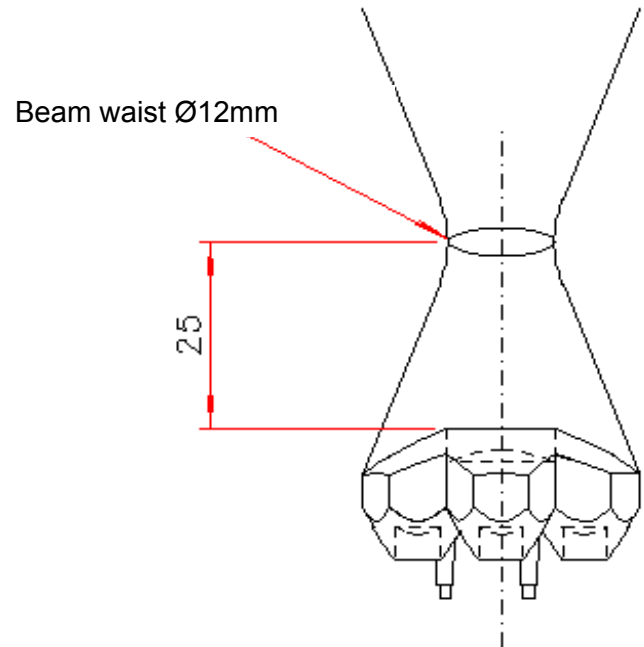

Raytrace Simulation of Typical Beam at 25mm on a 20mm x 20mm target with 7 White Dragon LED's

Typical Applications:

- Beam insertion into optical fibre bundles
- Beam insertion into edge of lightguides
- High intensity illumination of small objects for inspection and microscopy

Typical focused beam intensity at the 12mm aperture is >3,000,000 lux



Performance values given are typical values and will vary dependant on LED binning, colour and drive profile

Due to continuous product improvement, POL reserve the right to change specifications without notice.



Our Focus is in Plastics

Polymer Optics Ltd.

6 Kiln Ride, Wokingham, Berks.,
 RG40 3JL, England
 Tel/Fax: +44 (0) 1189 893341
 www.polymer-optics.co.uk

Single Cell LED Concentrator Lens - Part No. 141



- Designed to operate with Osram “Golden Dragon” LEDs
- Can also be used with the latest Dragon Plus and Platinum Dragon LED packages from Osram
- High light collection efficiency of >85%
- Precision moulded in optical grade Polycarbonate for thermal stability and system durability
- Part of the Polymer Optics “Modular LED Optics”® range

Polymer Optics “Modular LED Optics”® design, based on a hexagonal format, allows maximum packing density and assembly flexibility

Supplied with Holder (Part No. 127) to mount optics directly on to PCB's. Holder locates on LED package to ensure correct alignment

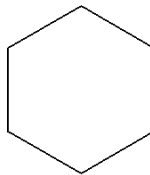

Typical dimensional tolerances to +/-0.2mm

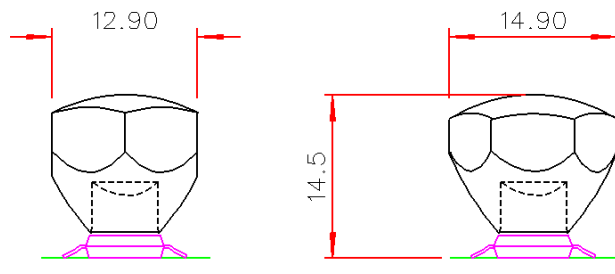

Typical Applications:

- Beam insertion into optical fibre bundles
- Beam insertion into edge of lightguides
- High intensity illumination of small objects for inspection and microscopy





**Polymer
Optics
Limited**

Our Focus is in Plastics

Polymer Optics Ltd.

6 Kiln Ride, Wokingham, Berks.,
RG40 3JL, England
Tel/Fax: +44 (0) 1189 893341
www.polymer-optics.co.uk

Single Cell LED Concentrator Lens - Part No. 141

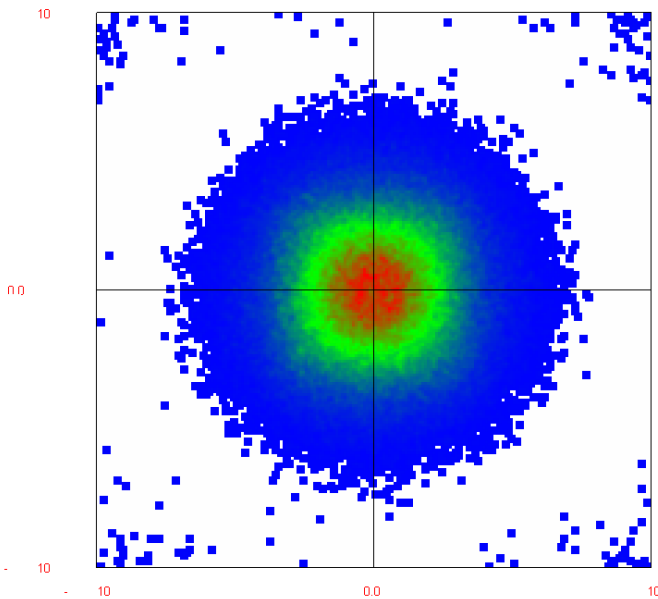
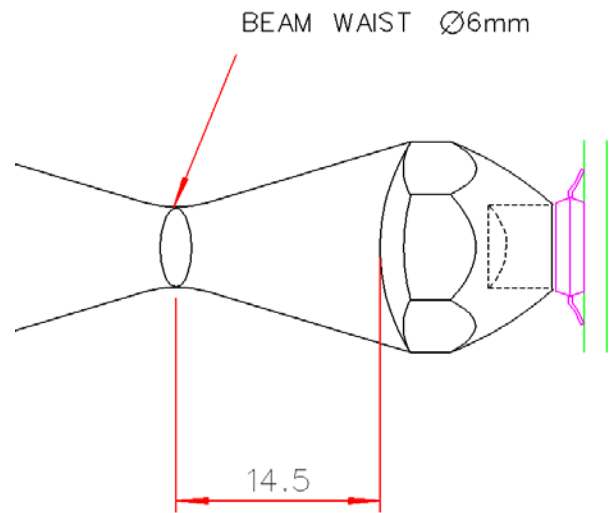

Raytrace Simulation of Typical Beam at 14.5mm on a 20mm x 20mm target with White Dragon LED

Typical focused beam peak intensity at the 6mm aperture is >850K lux



Performance values given are typical values and will vary dependant on LED binning, colour and drive profile

Due to continuous product improvement, POL reserve the right to change specifications without notice.

© Copyright Polymer Optics Limited 2008



**Polymer
Optics
Limited**

Our Focus is in Plastics

Polymer Optics Ltd.

6 Kiln Ride, Wokingham,
Berks., RG40 3JL, England
Tel/Fax: +44 (0) 1189 893341
www.polymer-optics.co.uk

6 Degree Diffuse LED Collimator Lens - Part No. 185

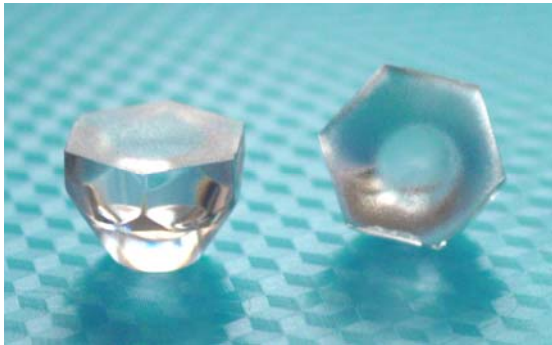

- Designed to operate with Osram “Golden Dragon” LEDs
- Can also be used with the latest Dragon Plus and Platinum Dragon LED packages from Osram
- High light collection efficiency of >85%
- Precision moulded in optical grade Polycarbonate for thermal stability and system durability
- Part of the Polymer Optics “Modular LED Optics”® range

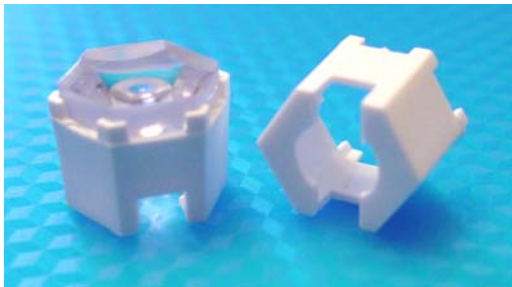

Typical dimensional tolerances to +/-0.2mm

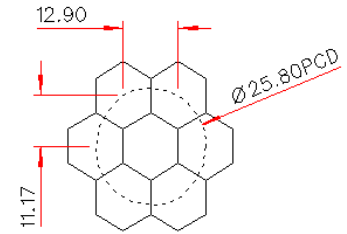
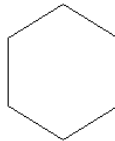

NESTED (

) PCD

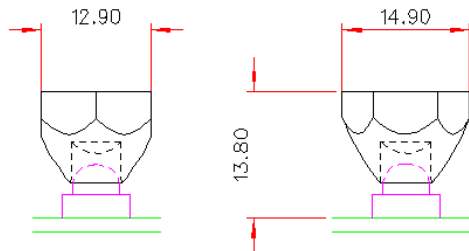

Polymer Optics “Modular LED Optics”® design, based on a hexagonal format, allows maximum packing density and assembly flexibility

Holder (Part No. 155) available for mounting optics onto the P3 and P4 High Power LED package.

Please refer to POL’s “Seoul Semiconductor LED Optic Product Range” brochure to determine the best optical function for your product application.



Our Focus is in Plastics

Polymer Optics Ltd.

6 Kiln Ride, Wokingham,
Berks., RG40 3JL, England
Tel/Fax: +44 (0) 1189 893341
www.polymer-optics.co.uk

Diffuse 6x15 Degree LED Collimator Lens - Part No. 216

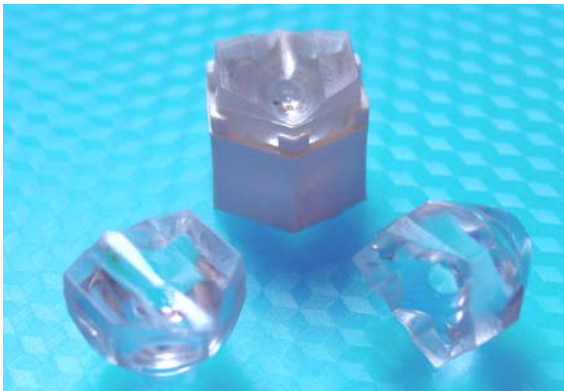

- Designed to operate with Osram “Golden Dragon” LEDs
- Can also be used with the latest Dragon Plus and Platinum Dragon LED packages from Osram
- High light collection efficiency of >85%
- Precision moulded in optical grade Polycarbonate for thermal stability and system durability
- Part of the Polymer Optics “Modular LED Optics”® range

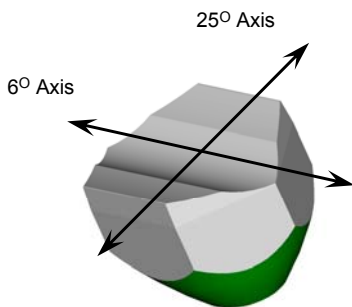

Typical dimensional tolerances
to +/-0.2mm

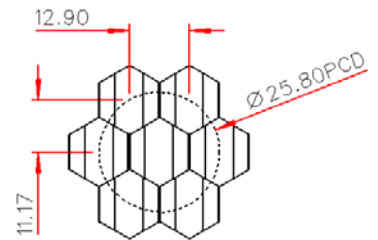
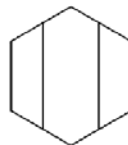

NESTED COMPONENTS ON 25,8MM PCD
(shown half size)

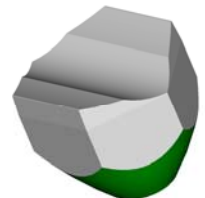
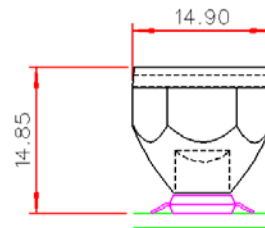
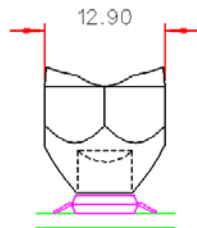

Polymer Optics “Modular LED Optics”® design, based on a hexagonal format, allows maximum packing density and assembly flexibility

Holder (Part No. 155) available for mounting optics onto the P3 and P4 High Power LED package.

Due to continuous product improvement, POL reserve the right to change specifications without notice.

© Copyright Polymer Optics Limited 2008



Our Focus is in Plastics

Polymer Optics Ltd.

6 Kiln Ride, Wokingham,
Berks., RG40 3JL, England
Tel/Fax: +44 (0) 1189 893341
www.polymer-optics.co.uk

Diffuse 15 Degree LED Collimator Lens - Part No. 217



- Designed to operate with Osram “Golden Dragon” LEDs
- Can also be used with the latest Dragon Plus and Platinum Dragon LED packages from Osram
- High light collection efficiency of >85%
- Precision moulded in optical grade Polycarbonate for thermal stability and system durability
- Part of the Polymer Optics “Modular LED Optics”® range

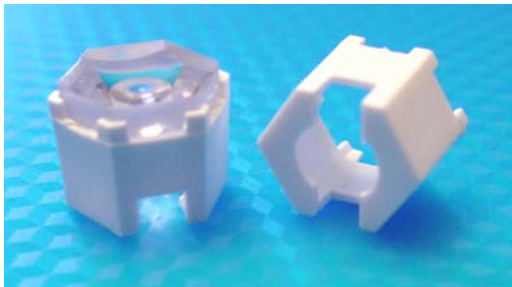

Typical dimensional tolerances
to +/-0.2mm

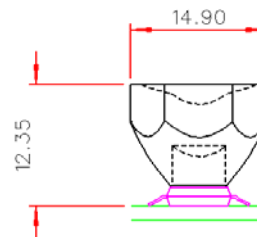
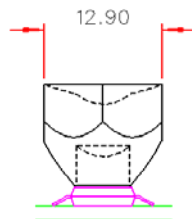
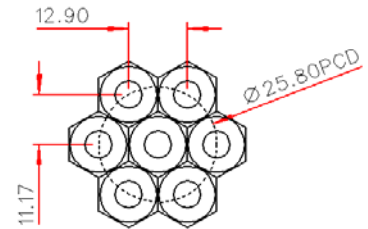
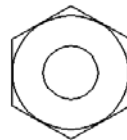

Polymer Optics “Modular LED Optics”® design, based on a hexagonal format, allows maximum packing density and assembly flexibility

Holder (Part No. 155) available for mounting optics onto the P3 and P4 High Power LED package.