

PHE 1100TGRSB

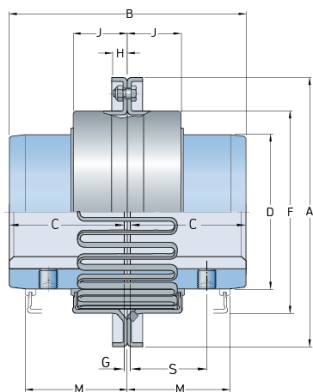

Size	1100
Nominal torque (Nm)	6280
Max speed (r/min)	3250
Min. bore (mm)	41
Max. bore (mm)	107
Weight (kg)	16.4