

Sep.1.2019 Copyright 2019 HIROSE ELECTRIC CO., LTD. All Rights Reserved.  
In case of consideration for using Automotive equipment / device which demand high reliability, kindly contact our sales window correspondents.

1> FIGURE-1 CONTACT No. MARKING (10:1)

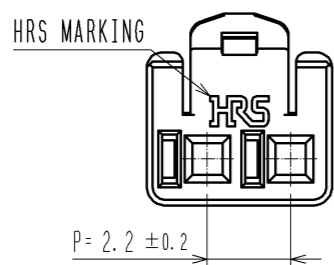

MATING FIGURE

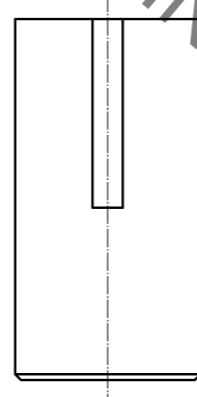
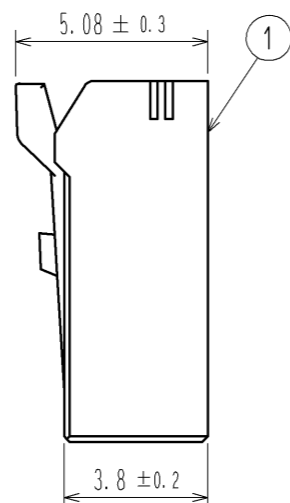
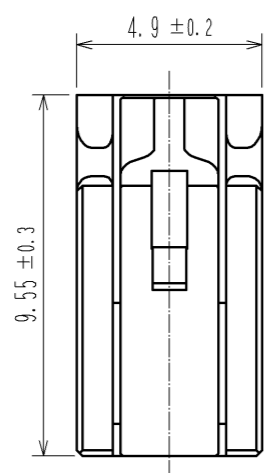
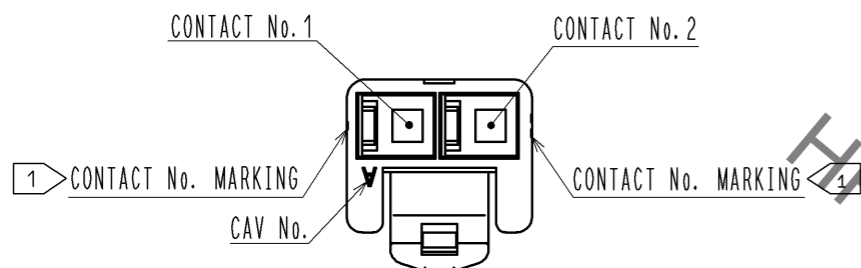
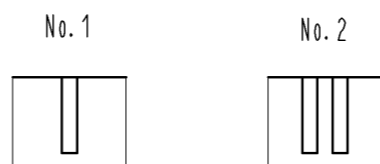
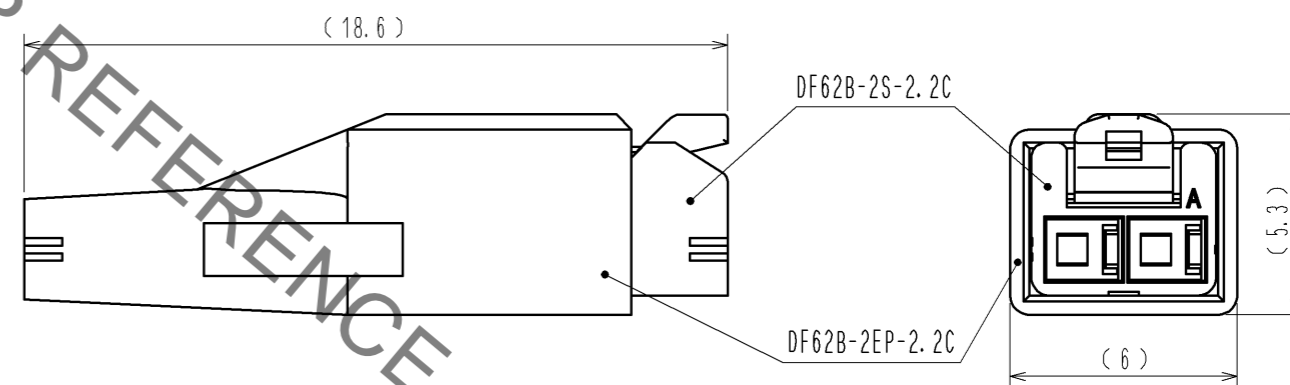

- NOTE. 1> MARKINGS AT THE INDICATED POSITIONS ARE CONTACT NO. MARKING. AND SHAPES ARE SHOWN IN FIGURE-1.  
2. PER PACK : 100 PIECES.  
3. THE DIMENSIONS IN PARENTHESIS ARE FOR REFERENCE.

| NO.         | MATERIAL                        | FINISH . REMARKS | NO.                               | MATERIAL | FINISH . REMARKS |
|-------------|---------------------------------|------------------|-----------------------------------|----------|------------------|
|             |                                 |                  | 1                                 | PBT      | UL94V-0 (WHITE)  |
| UNITS<br>mm |                                 | SCALE<br>5 : 1   | DESCRIPTION OF REVISIONS          |          | DESIGNED         |
| <b>HRS</b>  | HIROSE<br>ELECTRIC<br>CO., LTD. | COUNT<br>        | APPROVED : KI. AKIYAMA 13.06.06   |          | CHECKED          |
|             |                                 |                  | DRAWING NO. EDC3-351955-00        |          | DATE             |
|             |                                 |                  | CHECKED : MN. KENJO 13.06.06      |          |                  |
|             |                                 |                  | DESIGNED : TH. YOSHIKAWA 13.06.06 |          |                  |
|             |                                 |                  | DRAWN : TH. YOSHIKAWA 13.06.06    |          |                  |
|             |                                 |                  | PART NO. DF62B-2S-2.2C            |          |                  |
|             |                                 |                  | CODE NO. CL544-0551-0-00          |          |                  |
|             |                                 |                  |                                   |          | 1/1              |