

MARKING:

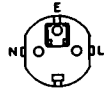

MARKING:

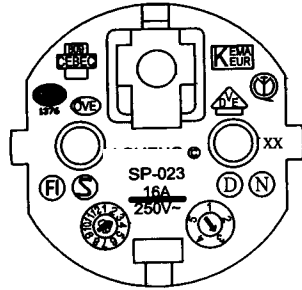
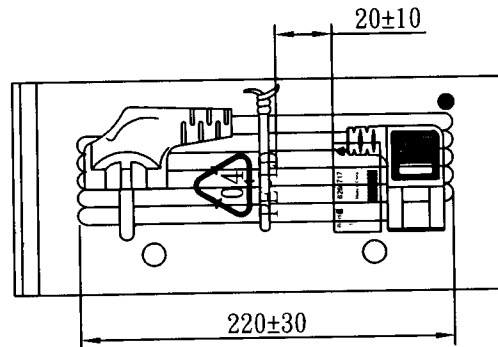
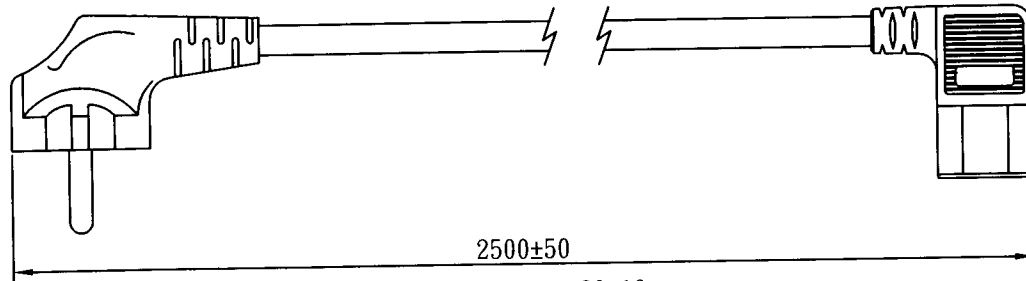
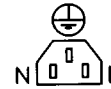
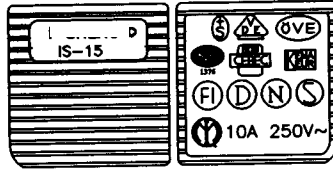
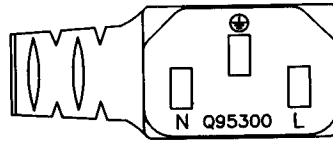

WIRING COLOR:

E: Yellow/Green  
N: Blue  
L: Brown

LENGTH ON CORD: (205-14)

SGIS <VDE> KEMA-KEUR <VE> <CEBEC 809> NF-USE 1346 IEMMEQU H05VV-F 3G 1.0mm<sup>2</sup> 60227 IEC 53 RVV 300/500V A003083 3ASL/100 4V-75 V-75(75°C) 250/440V ORDINARY DUTY Q90033 -LF- CE

| No | BOM ITEM               | Q' TY | P/N      |
|----|------------------------|-------|----------|
| 1  | SP-023 INSERT(BLACK)   | 1 PCS | MB023012 |
| 2  | PVC 45P (SA87, SP-023) | 45 g  | RPP0451H |
| 3  | KPR-14 TERMINAL        | 3 pcs | BBB14000 |
| 4  | IS-14 INNER BODY       | 1 set | MI014000 |
| 5  | PVC 45P (SA87, IS-15)  | 18 g  | RPP0451H |
| 6  | PE TIE (WHITE, 8 inch) | 1 pcs | KBW10008 |
| 7  | PE BAG                 | 1 pcs | KPR11000 |
| 8  | LABLE                  | 1 pcs |          |

NOTE : 1. CORD : EAN-128C

2 : SCAN CONTENT : 6266717

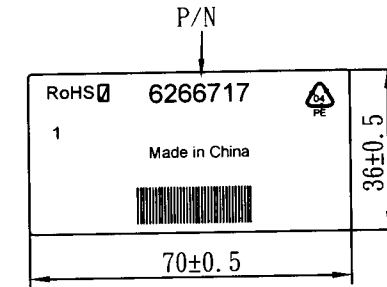

|                      |  |                    |             |                    |
|----------------------|--|--------------------|-------------|--------------------|
| CABLE                | H05VV-F 3G 1.0 DENT PRINT CT-1H (Gray) |                    |             |                    |
| PLUG                 | SP-023 + IS-15                         | LENGTH             | 2500        | UNIT mm            |
| CLIENT               | NAME                                   | First Connectivity | N/W         | 0.262064 UNIT kg   |
|                      | P/N                                    | 6266717            | SG DWG      | SR-142461-6 VER. A |
|                      |  | Design. by         | 楊望泰 9/26/14 |                    |
|                      |  | Review. by         |             |                    |
|                      |  | Approval. by       | [Signature] |                    |
| Y35 6C3016 1H 250 01 |  |                    |             |                    |