

Alle Rechte vorbehalten/ All rights reserved

X
Kontaktanordnung
Contact arrangement

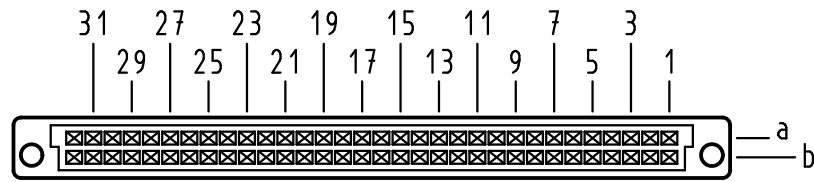

64 Einlöt-Kontakte
64 solder-contacts

- ☒ = Einlöt-Kontakt
= solder-contact
- = Kontaktposition nicht belegt
= position without contact

X
(Lochbild)
(Board drillings)

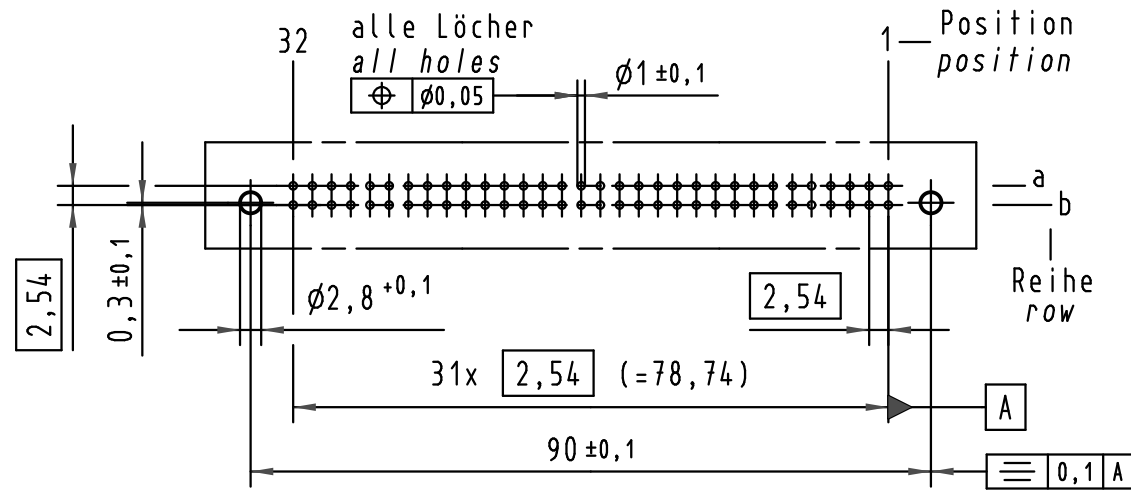

Z
2:1

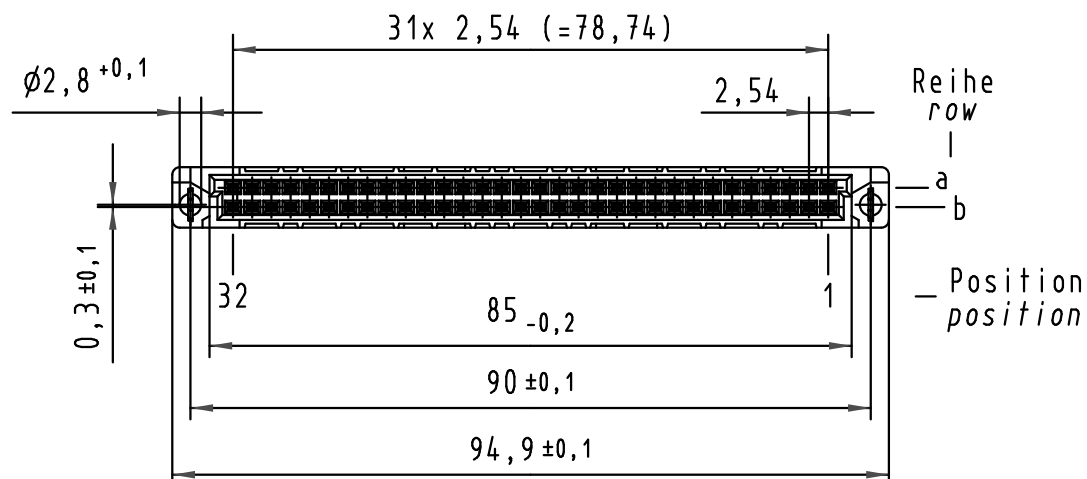
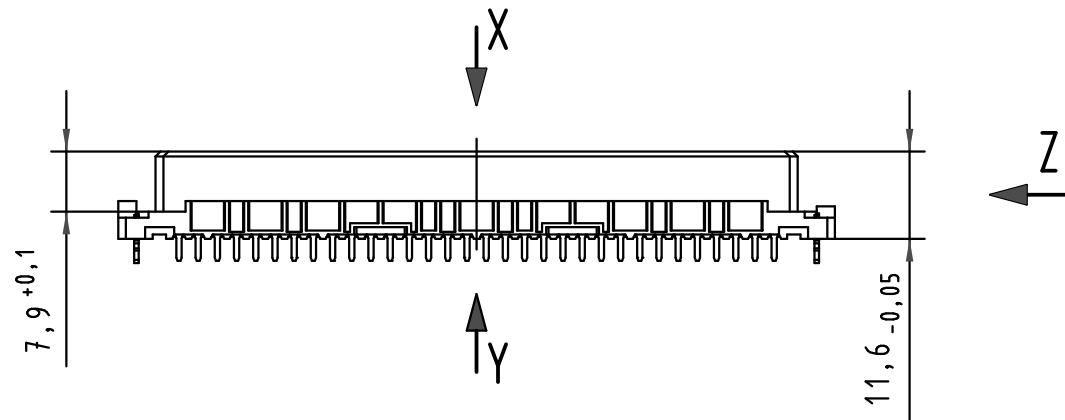
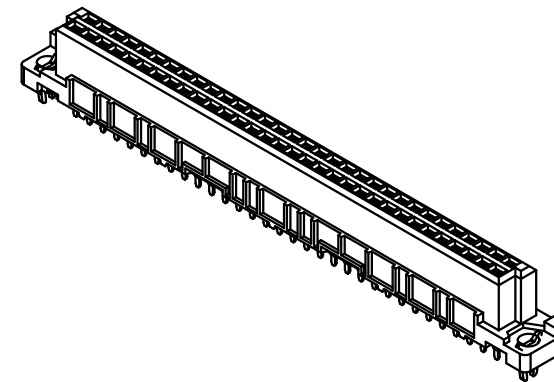
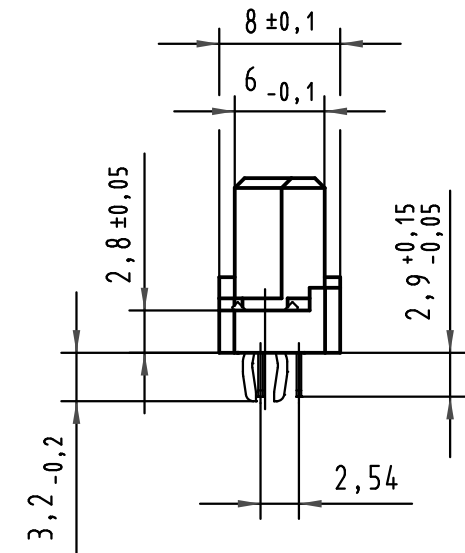

Y
10:1

Querschnitt der
Lötanschlüsse:
cross-section of
solder terminations:

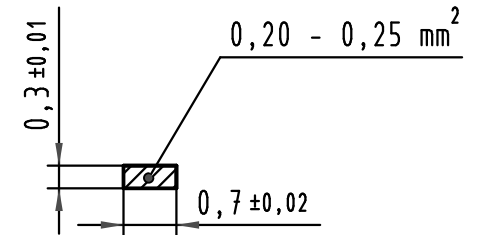

-	-	-
09 02 464 6824	2	Au über/over Ni
-	-	-
Bestell-Nr. part-no.	Anforderungsstufe nach IEC performance level acc.to IEC	Kontaktoberfläche contact plating

All Dimensions in mm Original Size DIN A 3			Techn. Character.			Nicht tolerierte Maß/Free size tolerances IEC 60603-2			
						har-bus B Federleiste mit Clip Einlöt 2,9 , 64 pol. har-bus B female connector with clip solder 2,9 , 64 pol.			
			Detail.	Dat.	Name				Maßstab/Scale 1:1 2:1
34306	02.07.07	LehT	Insp.	15.12.99	Pa.				
30231	08.02.02	Rie.	Stand.						
26962	24.01.00	Rie.	HARTING Electronics GmbH & Co. KG				TB 09 02 464 x824	Blatt/ page	
26935			D-32339 ESPELKAMP						
Mod.	Dat.	Name				Sub.			