



Brand of NTN Group

## Technical data

### UK212G2H

Insert bearings



Spherical outer diameter, fixing by adapter sleeve, seal with slinger

#### VISUAL (S)

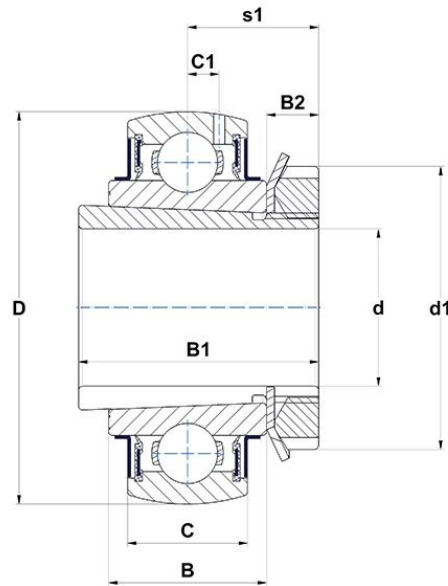

#### PRODUCT DEFINITION

<b>Brand</b>	SNR
<b>B - Width of Inner Ring</b>	36 mm
<b>B1 - Overall width Inner Ring</b>	62 mm
<b>B2 - Width of eccentric locking collar/nut</b>	13 mm
<b>C - Width of Outer Ring</b>	27 mm
<b>C1 - Distance center of OR to center of lubrication zone</b>	8,2 mm
<b>d - Shaft diameter</b>	55 mm
<b>d1 - Outer dia of eccent. Lock. collar / nut of adapter sleeve</b>	80 mm



**NTN Europe**

1 rue des Usines · BP 2017 · 74010 Annecy Cedex · France · Tel. +33 (0)4 50 65 30 00  
S.A. au capital de 322 639 919 € · RCS ANNECY B 325 821 072 · Id. Fiscale : FR 48 325 821 072  
SIRET 325 821 072 00015 · Code APE 2815 Z · Code NACE 28.15

### PRODUCT DEFINITION

<b>D - Outer diameter of OR</b>	110 mm
<b>f0 - Factor</b>	14.2

### PRODUCT PERFORMANCE

<b>C - Dynamic load rating</b>	52500000 mN
<b>C0 - Static load rating</b>	32800000 mN
<b>Operating temperature min.</b>	253,15 °K
<b>Operating temperature max.</b>	373,15 °K

### OTHER FEATURES

<b>Mass</b>	1,51 kg
<b>Adapter sleeve designation</b>	H2312

### BEARING FREQUENCIES

<b>BPFO - Over rolling frequency on outer ring (60 rpm)</b>	4.066 Hz
<b>BPFI - Over rolling frequency on inner (60 rpm)</b>	5.934 Hz
<b>BSF - Over rolling frequency on rolling element (60 rpm)</b>	5.168 Hz
<b>BRF - Rotational frequency - rolling element (60 rpm)</b>	2.584 Hz
<b>FTF - Rotational frequency - cage (60 rpm)</b>	0.407 Hz

