

C900AC SFTY X1-400 Y2-250, Ceramic, 2200 pF, 20%, 400 VAC (X1), 250 VAC (Y2), Y5U, Lead Spacing = 7.5mm

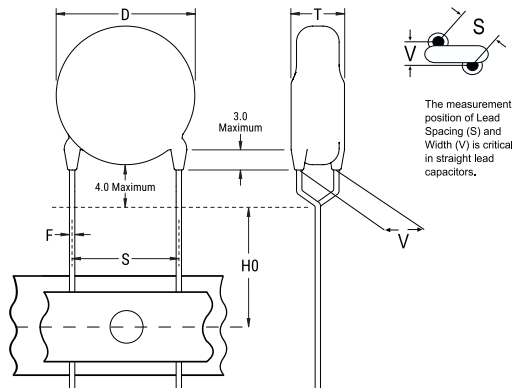

Dimensions

D	9mm MAX
T	5mm MAX
S	7.5mm +/-1mm
H0	18mm +2/-0mm
F	0.55mm +/-0.1mm

Packaging Specifications

Packaging:	Ammo
Packaging Quantity:	1000

General Information

Supplier:	KEMET
Series:	C900AC SFTY X1-400 Y2-250
Style:	Radial Disc
RoHS:	Yes
Termination:	Tin
Failure Rate:	N/A
Qualifications:	UL, ENEC, VDE, CSA, CAN
Halogen Free:	Yes

Specifications

Capacitance:	2200 pF
Capacitance Tolerance:	20%
Voltage AC:	400 VAC (X1), 250 VAC (Y2)
Dielectric Withstanding Voltage:	2600 VDC
Temperature Range:	-40/+125C
Temperature Coefficient:	Y5U
Dissipation Factor:	2.50%
Insulation Resistance:	10 GOhms
Safety Class:	X1/Y2

Statements of suitability for certain applications are based on our knowledge of typical operating conditions for such applications, but are not intended to constitute - and we specifically disclaim - any warranty concerning suitability for a specific customer application or use. This Information is intended for use only by customers who have the requisite experience and capability to determine the correct products for their application. Any technical advice inferred from this Information or otherwise provided by us with reference to the use of our products is given gratis, and we assume no obligation or liability for the advice given or results obtained.