

Product Overview

The MSCSM330AM15CD3NG device is a phase leg 3300V, 151A Silicon Carbide (SiC) power module. The following figures show the electrical diagram and pinout location of the device.

Figure 1. Electrical Diagram

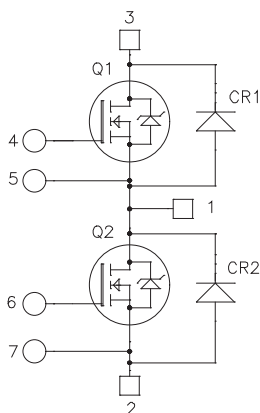
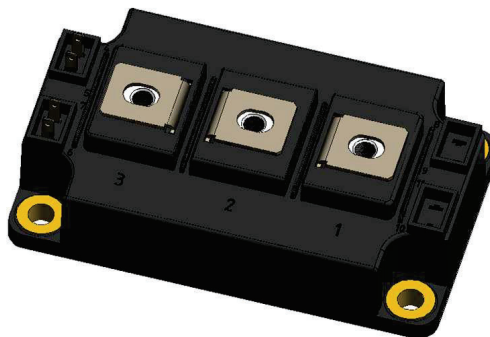
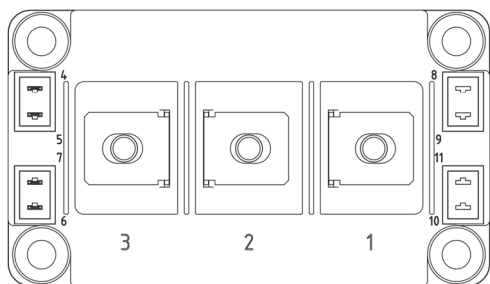

Figure 2. Pinout Location



Note: All ratings are at $T_j = 25\text{ }^\circ\text{C}$, unless otherwise specified.



These devices are sensitive to electrostatic discharge. Proper handling procedures must be followed.

Features

The MSCSM330AM15CD3NG device has the following key features:

- SiC Power MOSFET
 - Low $R_{DS(on)}$
 - Superior $R_{DS(on)}$ over temperature performance
- SiC Schottky Diode
 - Zero reverse recovery
 - Zero forward recovery
 - Temperature independent switching behavior
 - Positive temperature coefficient on VF
- CTI600 Plastic Enclosure with increased creepage & clearance
- Kelvin source to simplify gate drive
- Si_3N_4 substrate for improved reliability—thermal, power cycling
- Copper baseplate
- M6 power connectors

Benefits

The MSCSM330AM15CD3NG device has the following benefits:

- Outstanding performance at high temperature
- High reliability
- Direct mounting to heatsink (isolated package)
- Low junction-to-case thermal resistance
- RoHS Compliant

Application

The MSCSM330AM15CD3NG device has the following applications:

- Switched mode power supplies
- Rail converters
- Traction drive
- Pulsed Power
- Solid State Transformers

1. Electrical Specifications

The following sections show the electrical specifications of the MSCSM330AM15CD3NG device.

1.1. SiC MOSFET Characteristics (Per SiC MOSFET)

The following table lists the absolute maximum ratings (per SiC MOSFET) of the MSCSM330AM15CD3NG device.

Table 1-1. Absolute Maximum Ratings

Symbol	Parameter	Maximum Ratings	Unit
V_{DS}	Drain-source voltage	3300	V
I_D	Continuous drain current	$T_C = 25\text{ }^\circ\text{C}$	151
		$T_C = 80\text{ }^\circ\text{C}$	120
I_{DM}	Pulsed drain current	300	A
V_{GS}	Gate-source voltage	-10/23	V
$R_{DS(on)}$	Drain-source ON resistance	15.5	$m\Omega$
P_D	Power dissipation	$T_C = 25\text{ }^\circ\text{C}$	1013

The following table lists the electrical characteristics (per SiC MOSFET) of the MSCSM330AM15CD3NG device.

Table 1-2. Electrical Characteristics

Symbol	Characteristic	Test Conditions	Min.	Typ.	Max.	Unit	
I_{DSS}	Zero gate voltage drain current	$V_{GS} = 0V; V_{DS} = 3300V$	—	—	200	μA	
$R_{DS(on)}$	Drain-source ON resistance	$V_{GS} = 20V$ $I_D = 150A$	$T_J = 25\text{ }^\circ\text{C}$	—	13.5	15.5	$m\Omega$
			$T_J = 150\text{ }^\circ\text{C}$	—	32.4	—	
			$T_J = 175\text{ }^\circ\text{C}$	—	38.5	—	
$V_{GS(th)}$	Gate threshold voltage	$V_{GS} = V_{DS}; I_D = 14\text{ mA}$	1.9	2.7	—	V	
I_{GSS}	Gate-source leakage current	$V_{GS} = 20V; V_{DS} = 0V$	—	—	200	nA	

The following table lists the dynamic characteristics (per SiC MOSFET) of the MSCSM330AM15CD3NG device.

Table 1-3. Dynamic Characteristics

Symbol	Characteristic	Test Conditions	Min.	Typ.	Max.	Unit	
C_{iss}	Input capacitance	$V_{GS} = 0V$	—	17.5	—	nF	
C_{oss}	Output capacitance	$V_{DS} = 2640V$	—	0.39	—		
C_{rSS}	Reverse transfer capacitance	$f = 200 \text{ kHz}$	—	0.02	—		
Q_g	Total gate charge	$V_{GS} = -5/20V$	—	820	—	nC	
Q_{gs}	Gate-source charge	$V_{Bus} = 2640V$	—	276	—		
Q_{gd}	Gate-drain charge	$I_D = 140A$	—	266	—		
$t_{d(on)}$	Turn-on delay time	$V_{GS} = -5/20V$ $V_{Bus} = 1800V$ $I_D = 150A$ $R_{Gon} = 8.2\Omega$ $R_{Goff} = 3.3\Omega$	$T_J = 25^\circ\text{C}$	—	80	—	ns
t_r	Rise time		$T_J = 150^\circ\text{C}$	—	90	—	
			$T_J = 25^\circ\text{C}$	—	40	—	
$t_{d(off)}$	Turn-off delay time		$T_J = 150^\circ\text{C}$	—	45	—	
			$T_J = 25^\circ\text{C}$	—	175	—	
t_f	Fall time		$T_J = 150^\circ\text{C}$	—	318	—	
			$T_J = 25^\circ\text{C}$	—	65	—	
E_{on}	Turn-on energy		$T_J = 150^\circ\text{C}$	—	85	—	
		$T_J = 25^\circ\text{C}$	—	19.2	—		
E_{off}	Turn-off energy	$T_J = 25^\circ\text{C}$	—	33.9	—	mj	
		$T_J = 150^\circ\text{C}$	—	6.7	—		
R_{Gint}	Internal gate resistance		—	2.7	—	Ω	
R_{thJC}	Junction-to-case thermal resistance		—	—	0.148	$^\circ\text{C/W}$	

The following table lists the source to drain reverse ratings and characteristics (per SiC switch) of the MSCSM330AM15CD3NG device.

Table 1-4. Source to Drain Reverse Ratings and Characteristics

Symbol	Characteristic	Test Conditions	Min.	Typ.	Max.	Unit	
V_{SD}	Forward voltage	$V_{GS} = -5V$ $I_{SD} = 150A$	$T_J = 25^\circ\text{C}$	—	3.3	—	V
			$T_J = 175^\circ\text{C}$	—	3.6	—	
I_{rrm}	Reverse recovery current	$V_{GS} = -5V$ $V_{Bus} = 1800V$	$T_J = 25^\circ\text{C}$	—	39	—	A
			$T_J = 150^\circ\text{C}$	—	104	—	
Q_{rr}	Reverse recovery charge	$I_{SD} = 150A$ $R_{Gon} = 8.2\Omega$	$T_J = 25^\circ\text{C}$	—	2.6	—	μC
			$T_J = 150^\circ\text{C}$	—	9.3	—	
E_{rr}	Reverse recovery energy	$di/dt = 3.3 \text{ kA}/\mu\text{s}$	$T_J = 25^\circ\text{C}$	—	1.8	—	mj
			$T_J = 150^\circ\text{C}$	—	10	—	

1.2. SiC Diode Ratings and Characteristics (Per SiC Diode)

The following table lists the SiC diode ratings and characteristics of the MSCSM330AM15CD3NG device.

Table 1-5. SiC Diode Ratings and Characteristics (Per SiC Diode)

Symbol	Characteristic	Test Conditions		Min	Typ	Max	Unit
V_{RRM}	Peak repetitive reverse voltage			—	—	3300	V
I_{RRM}	Reverse leakage current	$V_R = 3300\text{ V}$		—	100	400	μA
I_F	DC forward current	$T_J = 175^\circ\text{C}$	$T_C = 80^\circ\text{C}$	—	70	—	A
V_F	Diode forward voltage	$I_F = 120\text{A}$	$T_J = 25^\circ\text{C}$	—	3.2	4	V
			$T_J = 175^\circ\text{C}$	—	8.5	—	
Q_C	Total capacitive charge	$V_R = 1650\text{ V}$		—	548	—	nC
C	Total capacitance	$f = 1\text{ MHz}, V_R = 1100\text{V}$		—	3.7	—	nF
		$f = 1\text{ MHz}, V_R = 2200\text{V}$		—	0.2	—	
R_{thJC}	Junction-to-case thermal resistance			—	—	0.264	$^\circ\text{C}/\text{W}$

1.3. Thermal and Package Characteristics

The following table lists the thermal and package characteristics of the MSCSM330AM15CD3NG device.

Table 1-6. Thermal and Package Characteristics

Symbol	Characteristic	Min.	Typ.	Max.	Unit		
V_{ISOL}	RMS isolation voltage, any terminal-to-case $t = 1\text{ min}$, 50/60 Hz	6	—	—	kV		
PDT	Partial discharge extinction voltage, RMS 50/60 Hz, $Q_{PD} < 10\text{ pC}$	2.6	—	—			
CTI	Comparative tracking index	600	—	—	—		
L_{stray}	Module stray inductance between V_{BUS} and $0/V_{BUS}$	—	16	—	nH		
d_{creep}	Creepage distance terminal-to-terminal	—	23	—	mm		
	Creepage distance terminal-to-baseplate	—	28.3	—			
d_{clear}	Clearance distance terminal-to-terminal	—	8.1	—			
	Clearance distance terminal-to-baseplate	—	23.4	—			
R_{DS}	Lead resistance terminal-to-chip	$T_C = 25^\circ\text{C}$, per switch		—	0.5	$\text{m}\Omega$	
T_J	Operating junction temperature range	-40	—	175	$^\circ\text{C}$		
T_{JOP}	Recommended junction temperature under switching conditions	-40	—	$T_{Jmax}-25$			
T_{STG}	Storage temperature range	-40	—	125			
T_C	Operating case temperature	-40	—	125			
τM	Mounting torque	To heatsink	M6	3	—	5	N.m
		For terminals	M6	3	—	5	
Wt	Package weight	—	350	—	g		

1.4. Typical SiC MOSFET Performance Curve

This section shows the typical SiC MOSFET performance curves of the MSCSM330AM15CD3NG device.

Figure 1-1. Output Characteristics, $T_J = 25\text{ }^\circ\text{C}$

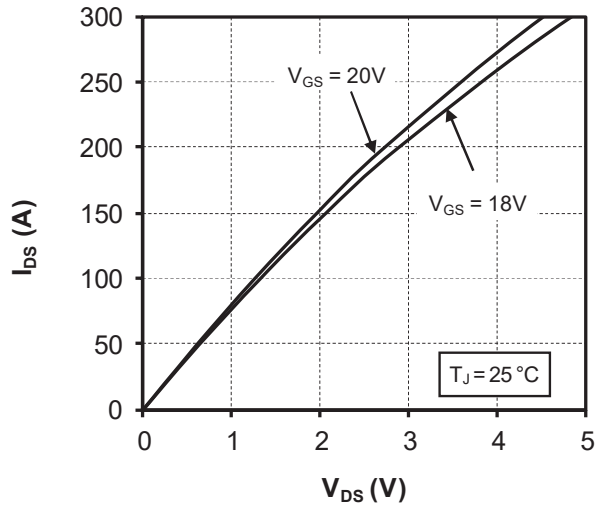

Figure 1-2. Output Characteristics, $T_J = 150\text{ }^\circ\text{C}$

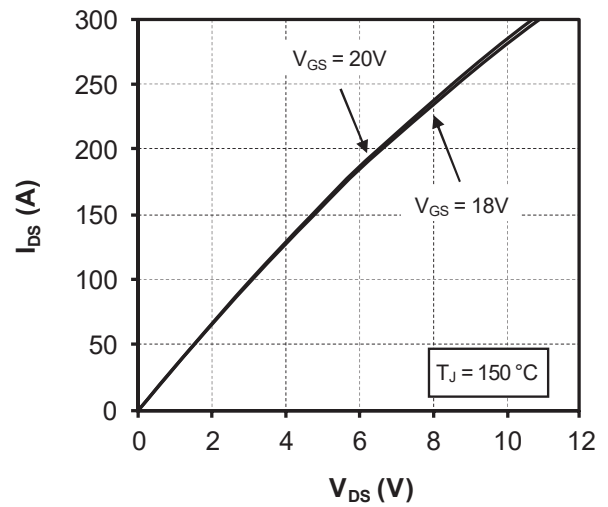

Figure 1-3. Output Characteristics, $T_J = 175\text{ }^\circ\text{C}$

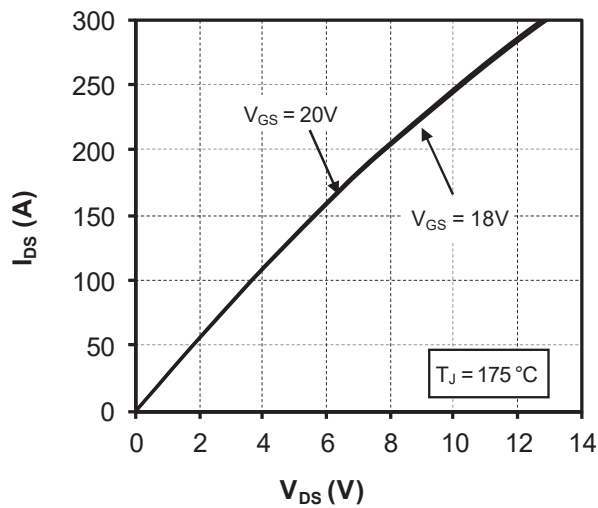

Figure 1-4. Normalized $R_{DS(on)}$ vs. Temperature

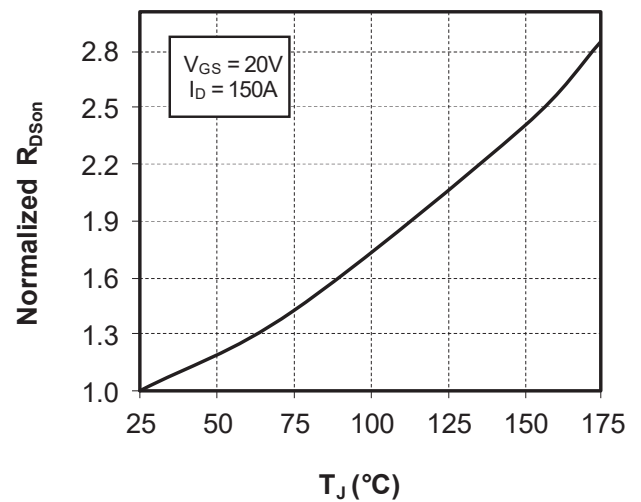

Figure 1-5. Switching Energy E_{on} vs. R_G

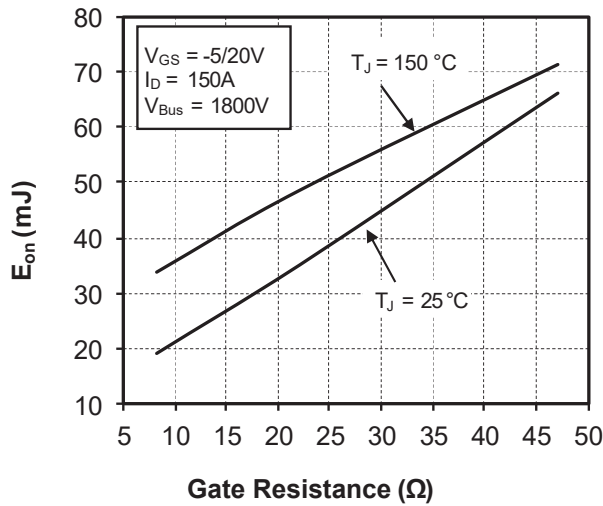

Figure 1-6. Switching Energy E_{off} vs. R_G

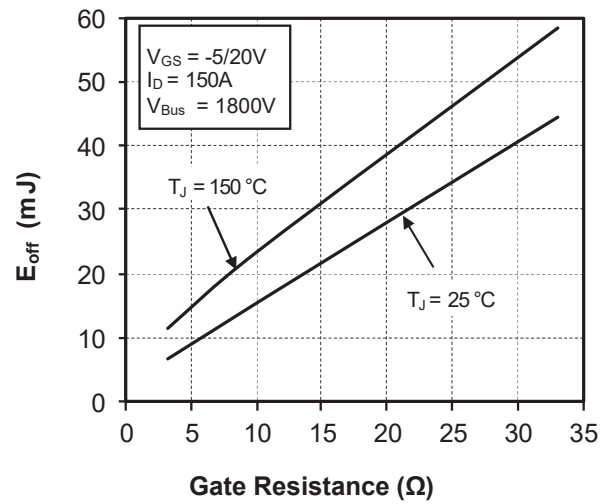

Figure 1-7. Switching Energy vs. Current

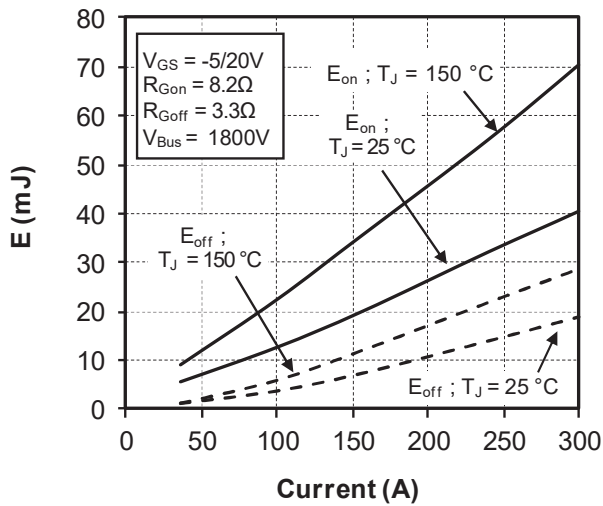

Figure 1-8. Operating Frequency vs. Drain Current

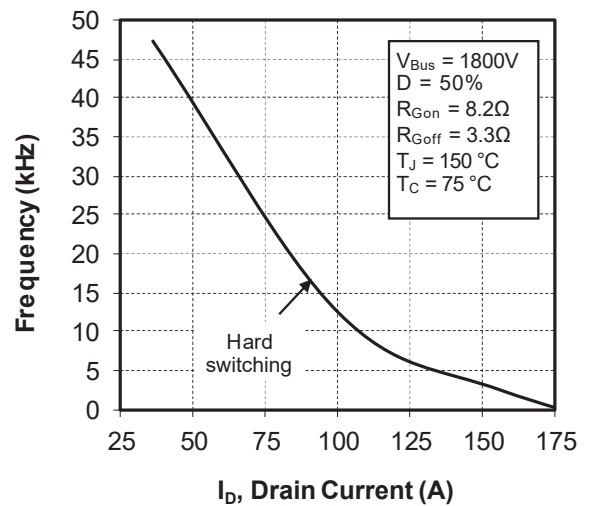

Figure 1-9. Capacitance vs. Drain Source Voltage

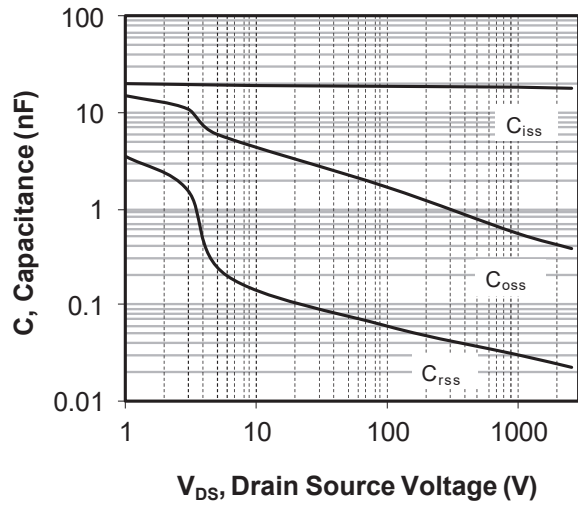

Figure 1-10. Gate Charge vs. Gate Source Voltage

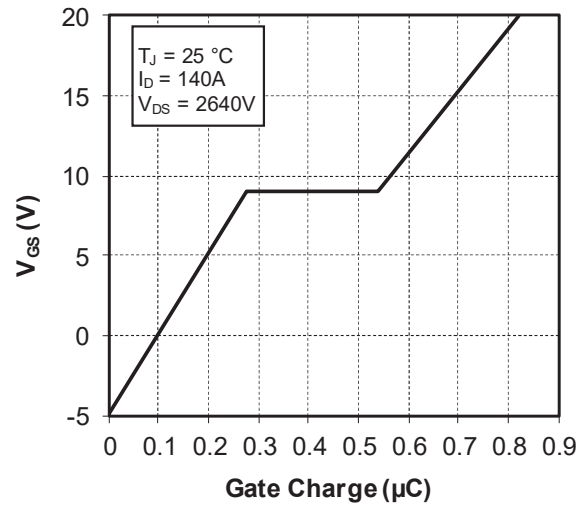

Figure 1-11. Reverse Recovery Energy vs. Current

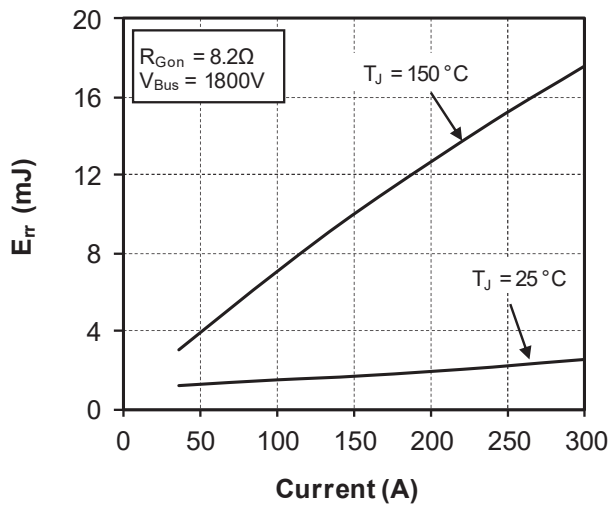

Figure 1-12. Reverse Recovery Energy vs. Gate Resistance

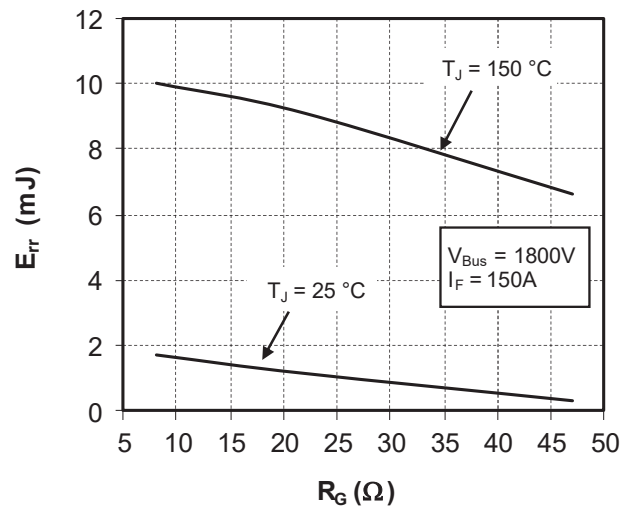

Figure 1-13. Maximum Thermal Impedance

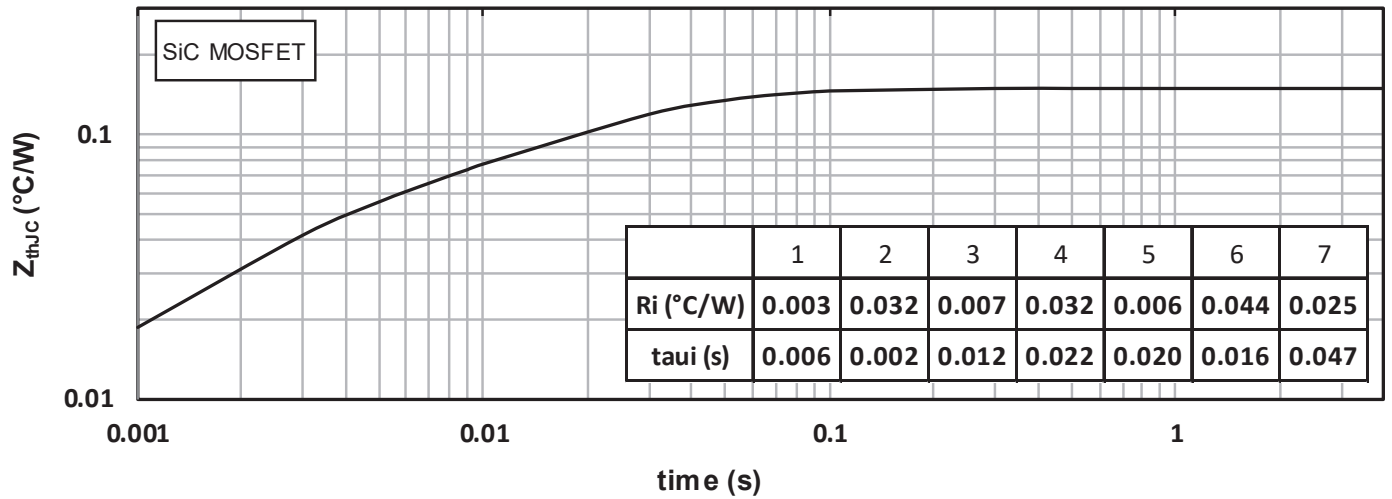

Figure 1-14. 3rd Quadrant Characteristics, $T_J = 25\text{ }^\circ\text{C}$

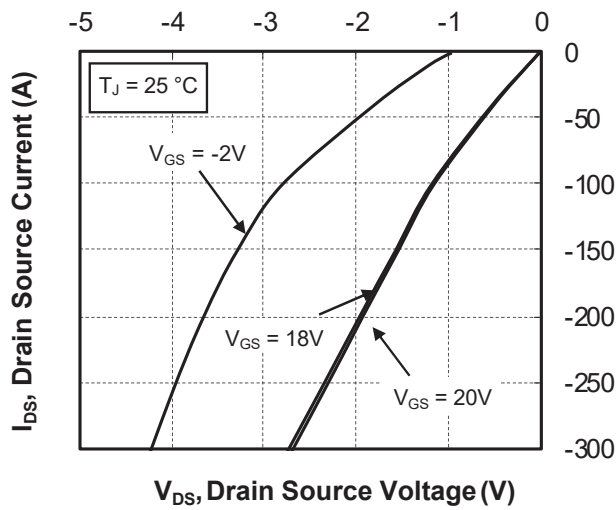

Figure 1-15. 3rd Quadrant Characteristics, $T_J = 150\text{ }^\circ\text{C}$

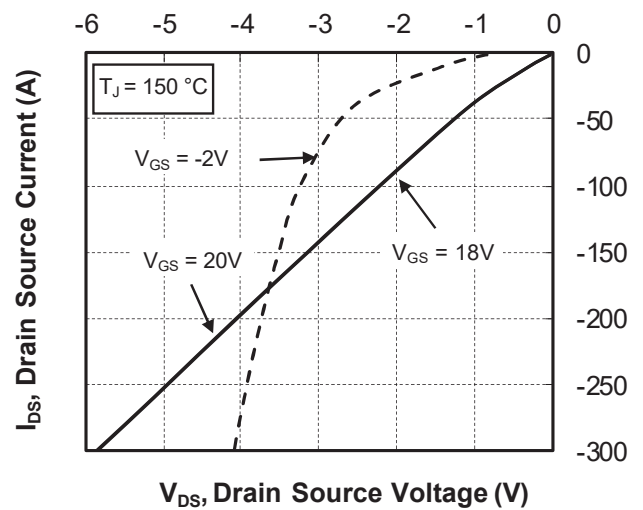

Figure 1-16. 3rd Quadrant Characteristics, $T_J = 175\text{ }^\circ\text{C}$

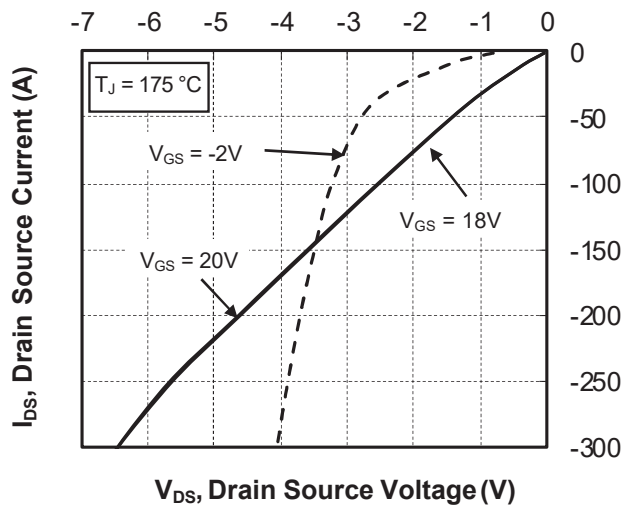

Figure 1-17. Drain Source Voltage Characteristics, $T_J = 25\text{ }^\circ\text{C}$

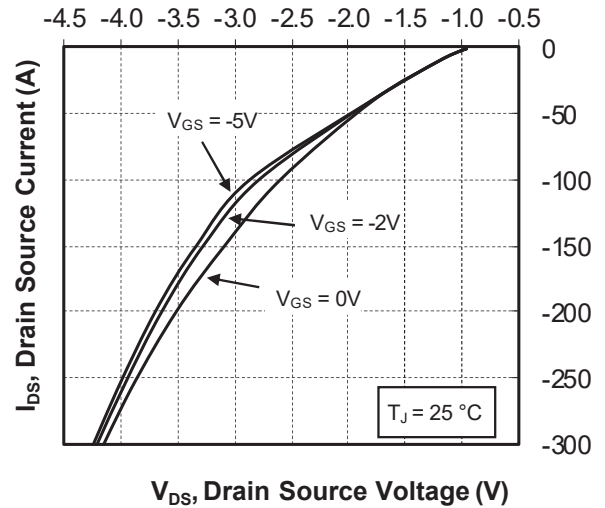

Figure 1-18. Drain Source Voltage Characteristics, $T_J = 150\text{ }^\circ\text{C}$

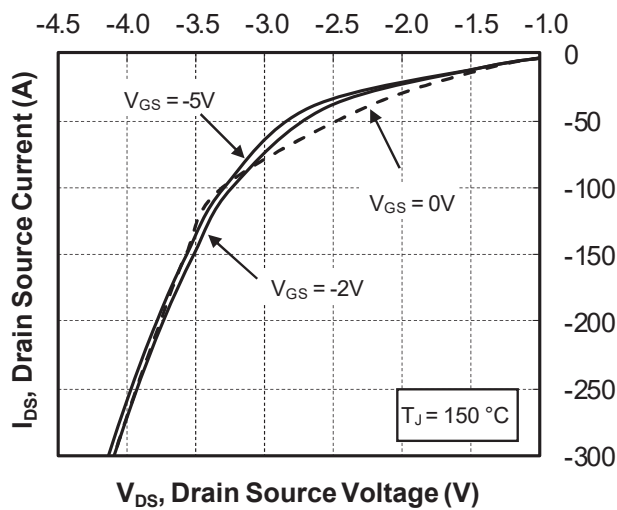

Figure 1-19. Drain Source Voltage Characteristics, $T_J = 175\text{ }^\circ\text{C}$

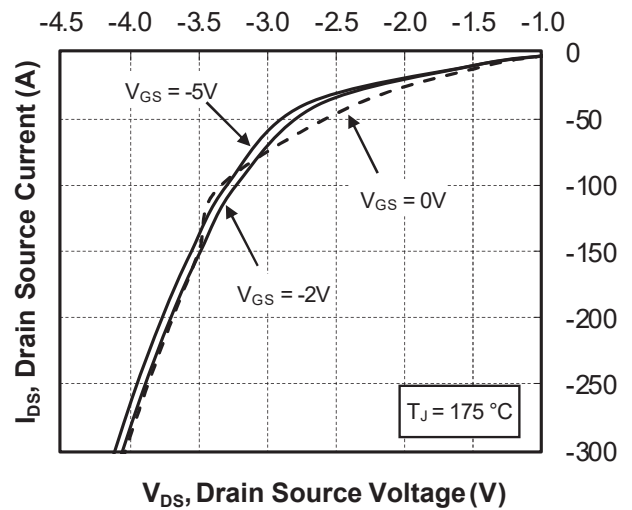

Figure 1-20. Maximum thermal impedance

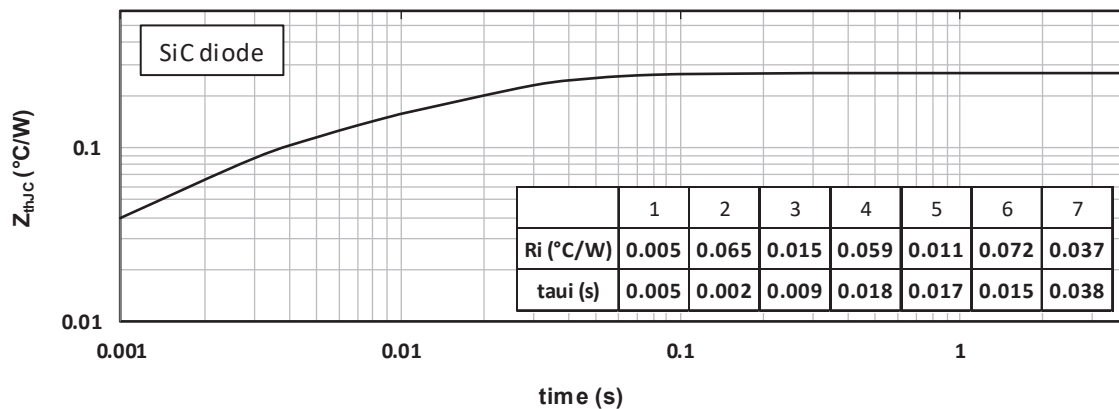
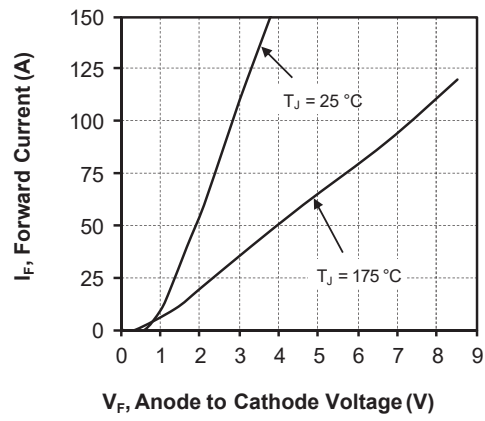

Figure 1-21. Forward Current vs Forward Voltage



2. Package Specifications

The following section shows the package specification of the MSCSM330AM15CD3NG device.

2.1. Package Outline

The following figure shows the package outline drawing of the MSCSM330AM15CD3NG device. The dimensions in the following figure are in millimeters.

Figure 2-1. Package Outline Drawing

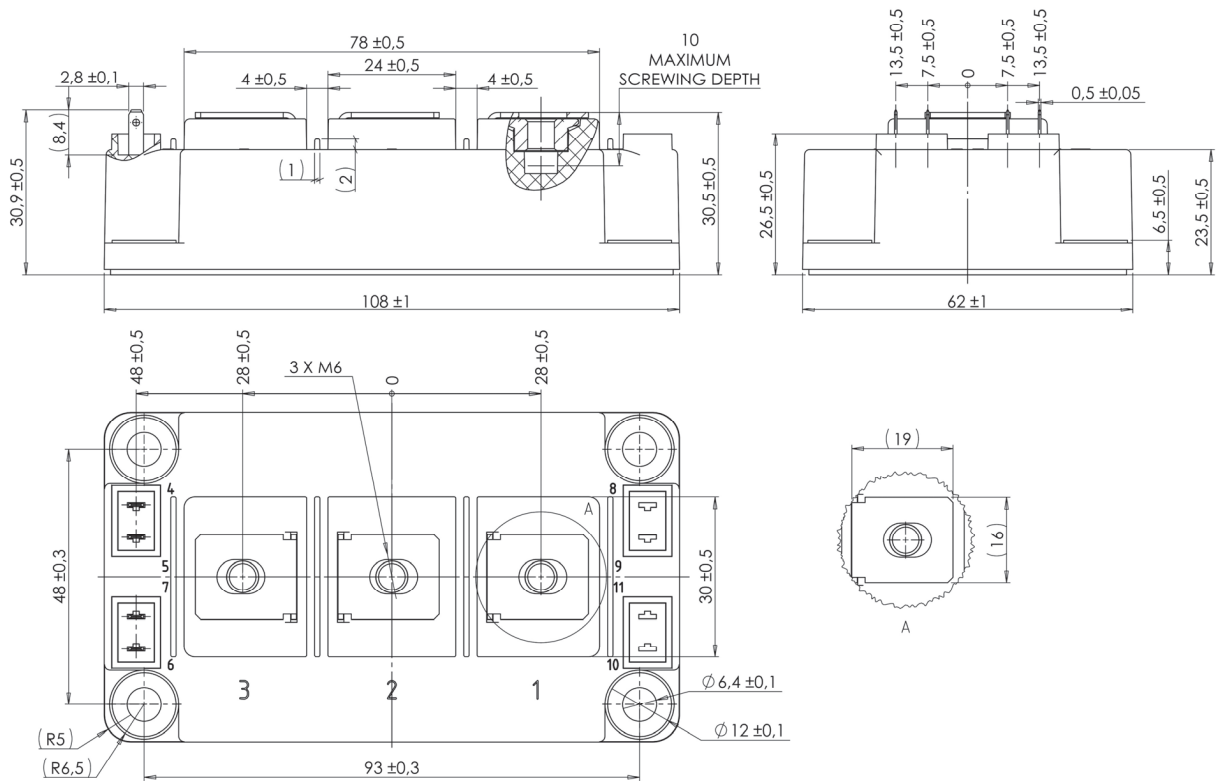

Note: For more information, see the latest application note on mounting instruction for D3 and D4 power modules, available on the Microchip website.

3. Revision History

The revision history describes the changes that were implemented in the document. The changes are listed by revision, starting with the most current publication.

Revision	Date	Description
A	10/2025	Initial Revision

Microchip Information

Trademarks

The “Microchip” name and logo, the “M” logo, and other names, logos, and brands are registered and unregistered trademarks of Microchip Technology Incorporated or its affiliates and/or subsidiaries in the United States and/or other countries (“Microchip Trademarks”). Information regarding Microchip Trademarks can be found at <https://www.microchip.com/en-us/about/legal-information/microchip-trademarks>.

ISBN: 979-8-3371-2126-0

Legal Notice

This publication and the information herein may be used only with Microchip products, including to design, test, and integrate Microchip products with your application. Use of this information in any other manner violates these terms. Information regarding device applications is provided only for your convenience and may be superseded by updates. It is your responsibility to ensure that your application meets with your specifications. Contact your local Microchip sales office for additional support or, obtain additional support at www.microchip.com/en-us/support/design-help/client-support-services.

THIS INFORMATION IS PROVIDED BY MICROCHIP “AS IS”. MICROCHIP MAKES NO REPRESENTATIONS OR WARRANTIES OF ANY KIND WHETHER EXPRESS OR IMPLIED, WRITTEN OR ORAL, STATUTORY OR OTHERWISE, RELATED TO THE INFORMATION INCLUDING BUT NOT LIMITED TO ANY IMPLIED WARRANTIES OF NON-INFRINGEMENT, MERCHANTABILITY, AND FITNESS FOR A PARTICULAR PURPOSE, OR WARRANTIES RELATED TO ITS CONDITION, QUALITY, OR PERFORMANCE.

IN NO EVENT WILL MICROCHIP BE LIABLE FOR ANY INDIRECT, SPECIAL, PUNITIVE, INCIDENTAL, OR CONSEQUENTIAL LOSS, DAMAGE, COST, OR EXPENSE OF ANY KIND WHATSOEVER RELATED TO THE INFORMATION OR ITS USE, HOWEVER CAUSED, EVEN IF MICROCHIP HAS BEEN ADVISED OF THE POSSIBILITY OR THE DAMAGES ARE FORESEEABLE. TO THE FULLEST EXTENT ALLOWED BY LAW, MICROCHIP’S TOTAL LIABILITY ON ALL CLAIMS IN ANY WAY RELATED TO THE INFORMATION OR ITS USE WILL NOT EXCEED THE AMOUNT OF FEES, IF ANY, THAT YOU HAVE PAID DIRECTLY TO MICROCHIP FOR THE INFORMATION.

Use of Microchip devices in life support and/or safety applications is entirely at the buyer’s risk, and the buyer agrees to defend, indemnify and hold harmless Microchip from any and all damages, claims, suits, or expenses resulting from such use. No licenses are conveyed, implicitly or otherwise, under any Microchip intellectual property rights unless otherwise stated.

Microchip Devices Code Protection Feature

Note the following details of the code protection feature on Microchip products:

- Microchip products meet the specifications contained in their particular Microchip Data Sheet.
- Microchip believes that its family of products is secure when used in the intended manner, within operating specifications, and under normal conditions.
- Microchip values and aggressively protects its intellectual property rights. Attempts to breach the code protection features of Microchip products are strictly prohibited and may violate the Digital Millennium Copyright Act.
- Neither Microchip nor any other semiconductor manufacturer can guarantee the security of its code. Code protection does not mean that we are guaranteeing the product is “unbreakable”. Code protection is constantly evolving. Microchip is committed to continuously improving the code protection features of our products.