

IEC Appliance Inlet C14 with Filter 2-Stage, Fuseholder 2-pole, Line Switch 2-pole

Standard- or Medical-Filter



Description

- Panel Mount:
Screw-on mounting from front side
- 4 Functions:
Appliance Inlet Protection class I, Fuseholder for fuse-links 5 x 20 mm 2-pole, Line Switch 2-pole, Line filter in standard and medical version, 2 positions
- Quick connect terminals 6.3 x 0.8 mm

Approvals

- VDE Certificate Number: 40004665
- UL File Number: E72928

Characteristics

- Compact design with optimal shielding
- All single elements are already wired
- Plug removal necessary for fuse-link replacement
- 2-stage line filter with increased attenuation
With EMC-shield
- Suitable for use in equipment according to IEC/UL 60950
Suitable for use in medical equipment according to IEC/UL 60601-1

Other versions on request

- Medical version M80

Weblinks

[pdf-datasheet](#), [html-datasheet](#), [General Product Information](#), [RoHS](#), [CHINA-RoHS](#), [REACH](#), [Mating Connectors](#), [e-Shop](#), [SCHURTER-Stock-Check](#), [Distributor-Stock-Check](#), [Accessories](#)

Technical Data

Ratings IEC	1 - 10A @ Ta 40 °C / 250 VAC; 50Hz
Ratings UL/CSA	1 - 10A @ Ta 40 °C / 125 VAC; 60Hz
Leakage Current	standard < 0.25 mA (250 V / 60 Hz) medical < 5 µA (250 V / 60 Hz)
Dielectric Strength	> 1.7 kVDC between L-N > 2.7 kVDC between L/N-PE Test voltage (2 sec)
Allowable Operation Temp.	-25 °C to 85 °C
Climatic Category	25/085/21 acc. to IEC 60068-1
Degree of Protection	from front side IP 40 acc. to IEC 60529
Protection Class	Suitable for appliances with protection class I acc. to IEC 61140
Terminal	Quick connect terminals 6.3 x 0.8 mm
Panel Thickness s	Screw: max 8 mm Mounting screw torque max 0.5 Nm
Material: Housing	Thermoplastic, black, UL 94V-0

Appliance-Inlet/-Outlet	C14 acc. to IEC 60320, UL 498, CSA C22.2 no. 42 (for cold conditions) pin-temperature 70 °C, 10A, Protection Class I
Fuseholder	2-pole, Shocksafe category PC2 acc. to IEC 60127-6, for fuse-links 5 x 20 mm
Rated Power Acceptance @ Ta 23 °C	5 x 20: 1.6W (2-pole)
Power Acceptance @ Ta > 23 °C	Admissible power acceptance at higher ambient temperature see derating curves
Line Switch	2-pole, non-illuminated, acc. to IEC 61058-1 Technical Details
Line Filter	Standard and Medical Version, IEC 60939, UL 1283, CSA C22.2 no. 8 Technical Details
MTBF	> 1'200'000h acc. to MIL-HB-217 F

Dimension

Case 45

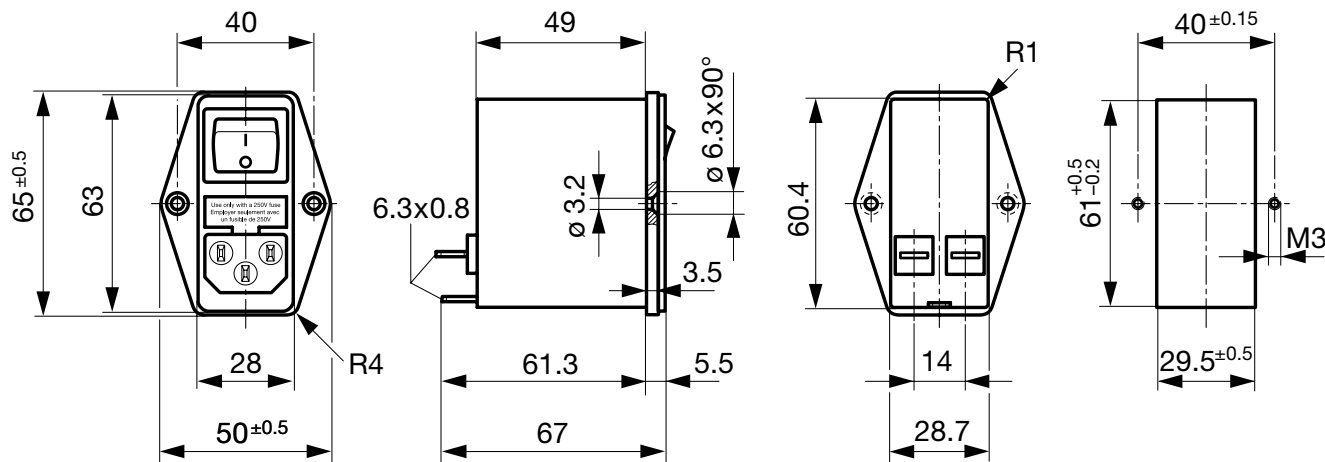

Technical Data of Filter-Components

Rated Current [A]	Filter-Type	Inductances L [mH]	Capacitance CX [nF]	Capacity Cy1 [nF]	Capacity Cy2 [nF]	R [MΩ]
1	Standard Version	2 x 10	68	1.5	1	1
2	Standard Version	2 x 4	68	1.5	1	1
4	Standard Version	2 x 1.5	68	1.5	1	1
6	Standard Version	2 x 0.8	68	1.5	1	1
10	Standard Version	2 x 0.3	68	1.5	1	1
1	Medical Version (M5)	2 x 10	68	-	-	1
2	Medical Version (M5)	2 x 4	68	-	-	1
4	Medical Version (M5)	2 x 1.5	68	-	-	1
6	Medical Version (M5)	2 x 0.8	68	-	-	1
10	Medical Version (M5)	2 x 0.3	68	-	-	1

Diagrams

Standard version

Medical version

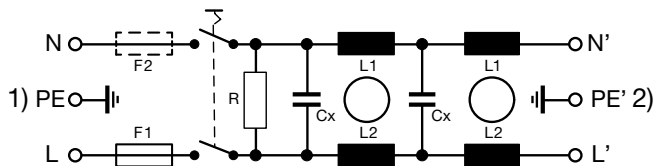
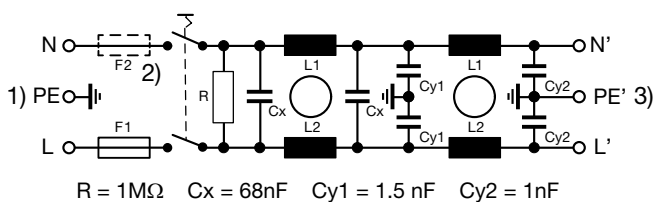

1) Line
2) only FKID
3) Load

1) Line
2) Load

Derating Curves

2-pole

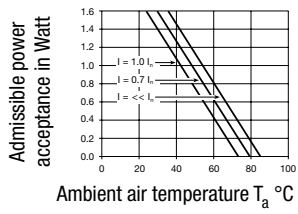

Attenuation Loss

--- differential mode ____ common mode

Standard version

1 A

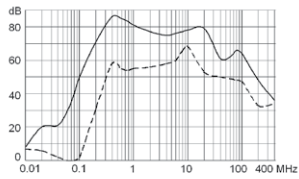

2 A

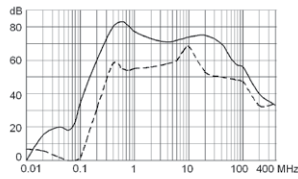

4 A

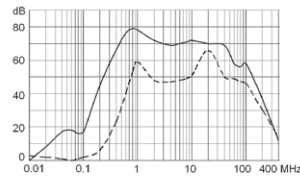

6 A

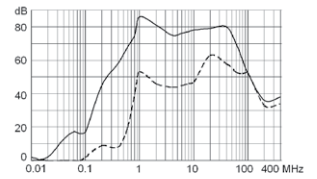

10 A

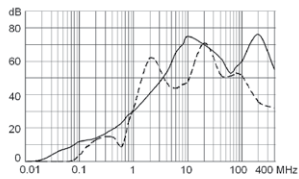

Medical version (M5)

1 A

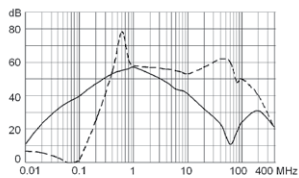

2 A

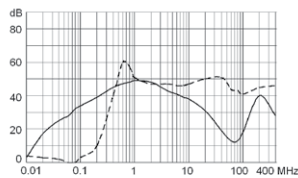

4 A

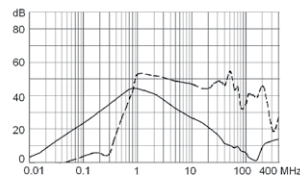

6 A

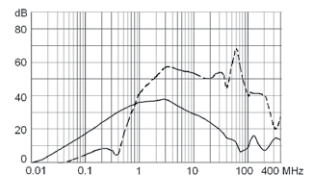

10 A

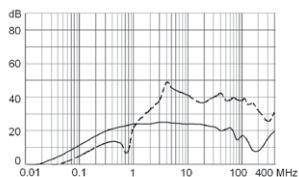

All Variants

Type	Rated Current [A]	Filter-Type	Fuseholder	Line Switch	Housing	Material: Housing	Order Number
FKID	1	Standard Version	2-pole	2-pole	45	Aluminum	4304.5061
FKID	2	Standard Version	2-pole	2-pole	45	Aluminum	4304.5062
FKID	4	Standard Version	2-pole	2-pole	45	Aluminum	4304.5063
FKID	6	Standard Version	2-pole	2-pole	45	Aluminum	4304.5064
FKID	10	Standard Version	2-pole	2-pole	45	Aluminum	4304.5065
FKID	1	Medical Version (M5)	2-pole	2-pole	45	Aluminum	4304.5081
FKID	2	Medical Version (M5)	2-pole	2-pole	45	Aluminum	4304.5082
FKID	4	Medical Version (M5)	2-pole	2-pole	45	Aluminum	4304.5083
FKID	6	Medical Version (M5)	2-pole	2-pole	45	Aluminum	4304.5084
FKID	10	Medical Version (M5)	2-pole	2-pole	45	Aluminum	4304.5085
FKID	1	Standard Version	2-pole	2-pole	45	Nickel plated steel	4304.5021
FKID	2	Standard Version	2-pole	2-pole	45	Nickel plated steel	4304.5022
FKID	4	Standard Version	2-pole	2-pole	45	Nickel plated steel	4304.5023
FKID	6	Standard Version	2-pole	2-pole	45	Nickel plated steel	4304.5024
FKID	10	Standard Version	2-pole	2-pole	45	Nickel plated steel	4304.5025
FKID	2	Medical Version (M5)	2-pole	2-pole	45	Nickel plated steel	4304.5067

Most Popular.

Availability for all products can be searched real-time:<http://www.schurter.com/en/Stock-Check/Stock-Check-SCHURTER>

Packaging unit 10 Pcs

Accessories

Description

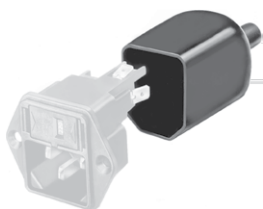

Assorted Covers
Rear Cover

Mating Outlets/Connectors

Category / Description

Appliance Outlet Overview complete



IEC Appliance Outlet F, Screw-on Mounting, Front Side, Solder Terminal	4787
IEC Appliance Outlet F, Snap-in Mounting, Front Side, Solder or Quick-connect Terminal	4788
IEC Appliance Outlet F or H, Screw-on Mounting, Front Side, Solder, PCB or Quick-connect Terminal	5091

Appliance Outlet further types to FKID

Connector Overview complete



IEC Connector C13, Rewireable, Straight	4782
IEC Connector C13, Rewireable, Straight	4022
IEC Connector C13, Rewireable, Angled	4785
IEC Connector C13, Rewireable, Angled	4300-06
IEC Connector C13, Rewireable, Angled	4012

Connector further types to FKID

...