

# PROGRAMMABLE HIGH-FREQUENCY CRYSTAL OSCILLATOR SG-8002DB / DC series

Product number (please refer to page 2)

**Q3203DBxxxxxx00**

**Q3204DCxxxxxx00**

- Wide frequency output by PLL technology.
- Quick delivery of samples and short lead mass production time.
- Excellent environmental capability.
- Output enable function (OE) and stand-by function (ST) can be used for low current consumption applications.
- Pin compatible with full size and half size.
- Available for lead (Pb)-free soldering.
- Available for lead (Pb)-free terminal.

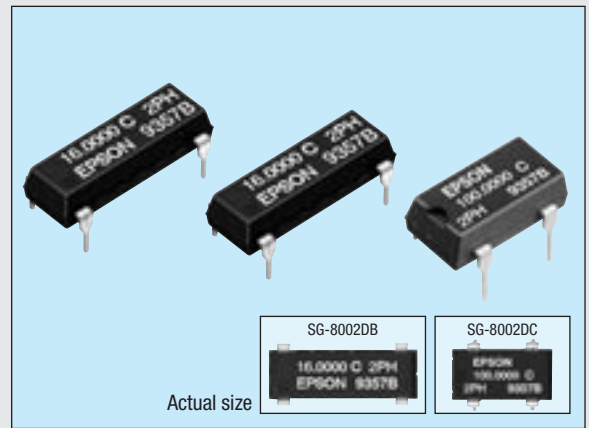

SG-Writer available to purchase.  
Please contact EPSON or local sales representative.

## Specifications (characteristics)

Item	Symbol	Specifications *2			Remarks	
		PT / ST	PH / SH	PC / SC		
Output frequency range	f <sub>o</sub>	1.0000 MHz to 125.0000 MHz			Refer to page 50. "Frequency range"	
Power source voltage	Max. supply voltage	V <sub>DD</sub> -GND	-0.5 V to +7.0 V			
	Operating voltage	V <sub>DD</sub>	5.0 V ±0.5 V	3.3 ± 0.3 V	2.7 V to 3.6 V : f <sub>o</sub> ≤ 66.7 MHz (PC / SC)	
Temperature range	Storage temperature	T <sub>STG</sub>	-55 °C to +125 °C		Stored as bare product after unpacking	
	Operating temperature	T <sub>OPR</sub>	-20 °C to +70 °C (-40 °C to +85 °C)	-40 °C to +85 °C	Refer to page 50. "Frequency range"	
Frequency stability	Δf/f <sub>o</sub>	B: ±50 x 10 <sup>-6</sup> C: ±100 x 10 <sup>-6</sup>			B, C : -20 °C to +70 °C	
		M: ±100 x 10 <sup>-6</sup>			M : -40 °C to +85 °C	
Current consumption	I <sub>OP</sub>	45 mA Max.		28 mA Max.	No load condition, Max. frequency range	
Output disable current	I <sub>OE</sub>	30 mA Max.		16 mA Max.	OE = GND (PT, PH, PC)	
Standby current	I <sub>ST</sub>	50 μA Max.			ST = GND (ST, SH, SC)	
Duty *1	tw/ t	-			40 % to 60 %	CMOS load: 1/2 V <sub>DD</sub> level
		40 % to 60 %			-	TTL load: 1.4 V level
High output voltage	V <sub>OH</sub>	V <sub>DD</sub> -0.4 V Min.			I <sub>OH</sub> = -16 mA (PT / ST, PH / SH), -8 mA (PC / SC)	
Low output voltage	V <sub>OL</sub>	0.4 V Max.			I <sub>OL</sub> = 16 mA (PT / ST, PH / SH), 8 mA (PC / SC)	
Output load *1 condition (fan out)	TTL	N	5 TTL Max.	-	Max. frequency and Max. operating voltage range	
	CMOS	CL	15 pF Max.	25 pF Max. 15 pF Max.		
Output enable / disable input voltage	V <sub>IH</sub>	2.0 V Min.		0.7 V <sub>DD</sub> Min.	ST, OE terminal	
	V <sub>IL</sub>	0.8 V Max.		0.2 V <sub>DD</sub> Max.		
Output rise time *1	CMOS level	t <sub>r</sub>	-		4 ns Max.	CMOS load: 20 % → 80 % V <sub>DD</sub>
	TTL level		4 ns Max.	-	TTL load: 0.4 V → 2.4 V	
Output fall time *1	CMOS level	t <sub>f</sub>	-		4 ns Max.	CMOS load: 80 % → 20 % V <sub>DD</sub>
	TTL level		4 ns Max.	-	TTL load: 2.4 V → 0.4 V	
Oscillation start up time	t <sub>OSC</sub>	10 ms Max.			Time at minimum operating voltage to be 0 s	
Aging	f <sub>a</sub>	±5 x 10 <sup>-6</sup> / year Max.			T <sub>a</sub> = +25 °C, V <sub>DD</sub> = 5.0 V / 3.3 V, First year	
Shock resistance	S.R.	±20 x 10 <sup>-6</sup> Max.			Three drops on a hard board from 750 mm or excitation test with 29400 m/s <sup>2</sup> x 0.3 ms x 1/2sine wave in 3 directions	

\*1 Operating temperature (-40 °C to +85 °C), the available frequency, duty and output load conditions, please refer to page 50, 51.

\*2 PLL - PLL connection & Jitter specification, please refer to page 52.

Checking possible by the Frequency Checking Program.







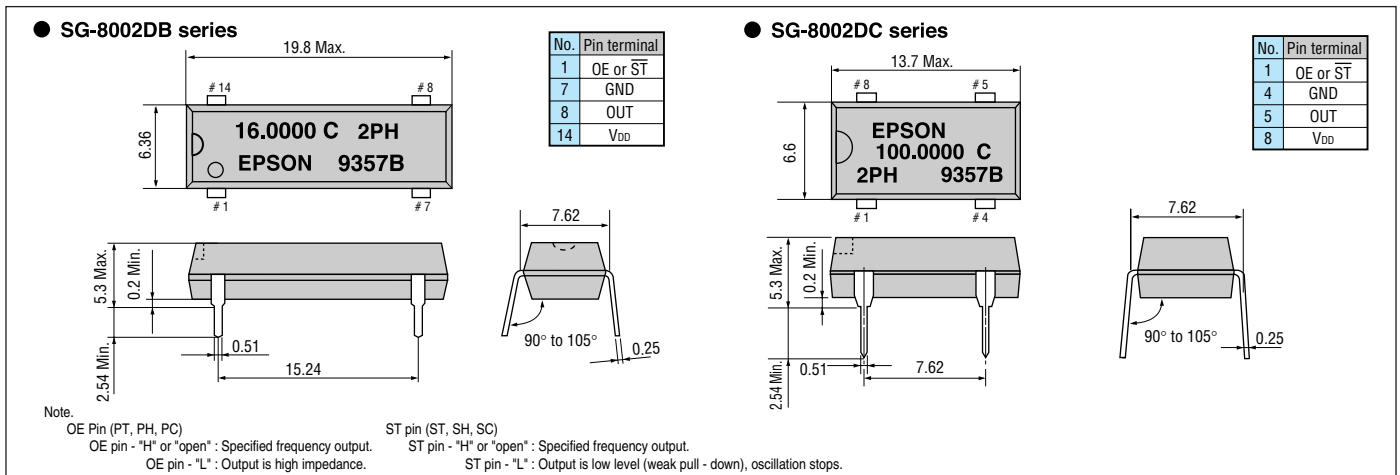



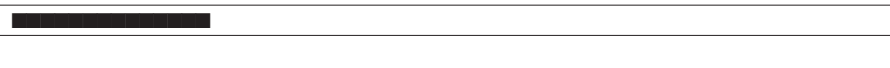

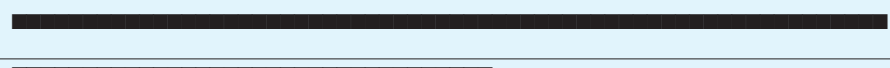
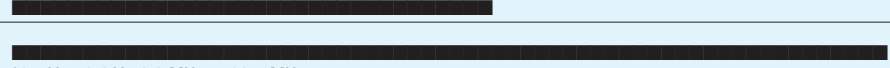
<http://www.epsondevice.com/domcfg.nsf>

## External dimensions

(Unit: mm)

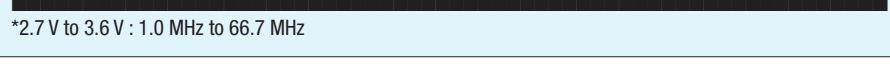

### ■ Frequency range of SG-8002 or HG-8002 series

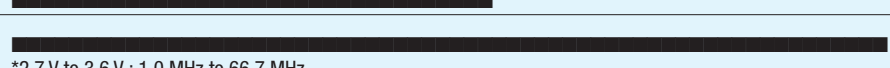
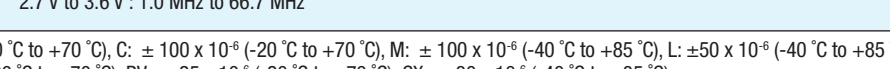
page	Model	Operating voltage	Frequency stability Operating temperature	1 MHz	27 MHz	40 MHz	55 MHz	80 MHz	125 MHz
43	SG-8002LA SG-8002LB	PH SH	5.0 V ± 0.5 V	B C					
				M					
		PC SC	3.3 V ± 0.3 V *	B C L M	*2.7 V to 3.6 V : 1.0 MHz to 66.7 MHz 				
46 48 49	SG-8002CA SG-8002JA SG-8002DB SG-8002DC	PT ST PH SH	4.5 V to 5.5 V	B C					
				M					
		PC SC	3 V to 3.6 V (2.7 V to 3.6 V)	B C M	*2.7 V to 3.6 V : 1.0 MHz to 66.7 MHz 				
47	SG-8002JC	PT ST PH SH	4.5 V to 5.5 V	B C					
		PC SC	3 V to 3.6 V (2.7 V to 3.6 V)	B C	*2.7 V to 3.6 V : 1.0 MHz to 66.7 MHz 				
45	SG-8002JF	PT ST PH SH	4.5 V to 5.5 V	B C					
				M					
		PC SC	3 V to 3.6 V (2.7 V to 3.6 V)	B C M	*2.7 V to 3.6 V : 1.0 MHz to 66.7 MHz 				
44	SG-8002CE	PT ST PH SH	4.5 V to 5.5 V	B C					
				M					
		PC SC	3 V to 3.6 V (2.7 V to 3.6 V)	B C M	*2.7 V to 3.6 V : 1.0 MHz to 66.7 MHz 				
64	HG-8002JA	PT ST PH SH	5 V ± 0.25 V	AV BV					
				CX					
		PC SC	3 V ± 0.165 V	AV BV CX	*2.7 V to 3.6 V : 1.0 MHz to 66.7 MHz 				

Frequency stability Operating temperature : B: ± 50 x 10<sup>-6</sup> (-20 °C to +70 °C), C: ± 100 x 10<sup>-6</sup> (-20 °C to +70 °C), M: ± 100 x 10<sup>-6</sup> (-40 °C to +85 °C), L: ± 50 x 10<sup>-6</sup> (-40 °C to +85 °C)  
AV: ± 20 x 10<sup>-6</sup> (-20 °C to +70 °C), BV: ± 25 x 10<sup>-6</sup> (-20 °C to +70 °C), CX: ± 30 x 10<sup>-6</sup> (-40 °C to +85 °C)



# PLL oscillator (SG-8002 series and HG-8002 series)

## ■ PLL-PLL connection

Because of using a PLL technology, there are a few case that the jitter value will increase when SG-8002 is connected the other PLL-oscillator.

In our experience, we are unable to recommend these products for the application such as telecom carrier use or video clock use. Please take careful checking in advance for these application (Jitter specification is Max. 250 ps / CL = 15 pF)

## ■ Remarks on noise management for power supply line

We recommend not to insert the filter and or another devices in the power supply line as the counter measure of EMI noise reduction. This device insertion might cause high-frequency impedance high in the power supply line and it affects oscillator stable drive.

When this measure is required. please evaluate circuitry and device behaviour in the circuit and verify that won't affect oscillation. And start up time (0% VDD to 90% VDD) of power source should be more than 150 μs.

## ■ Jitter Specifications

Model	Operating Voltage	Jitter Item	Specifications	Remarks
PT / PH ST / SH	5 V ±0.5 V	Cycle to cycle	150 ps Max.	33 MHz ≤ fo ≤ 125 MHz, CL = 15 pF
			200 ps Max.	1.0 MHz ≤ fo < 33 MHz, CL = 15 pF
		Peak to peak	200 ps Max.	33 MHz ≤ fo ≤ 125 MHz, CL = 15 pF
			250 ps Max.	1.0 MHz ≤ fo < 33 MHz, CL = 15 pF
SC / PC	3.3 V ±0.3 V	Cycle to cycle	200 ps Max.	1.0 MHz ≤ fo ≤ 125 MHz, CL = 15 pF
		Peak to peak	250 ps Max.	1.0 MHz ≤ fo ≤ 125 MHz, CL = 15 pF

## ■ SG-8002 series Characteristics chart

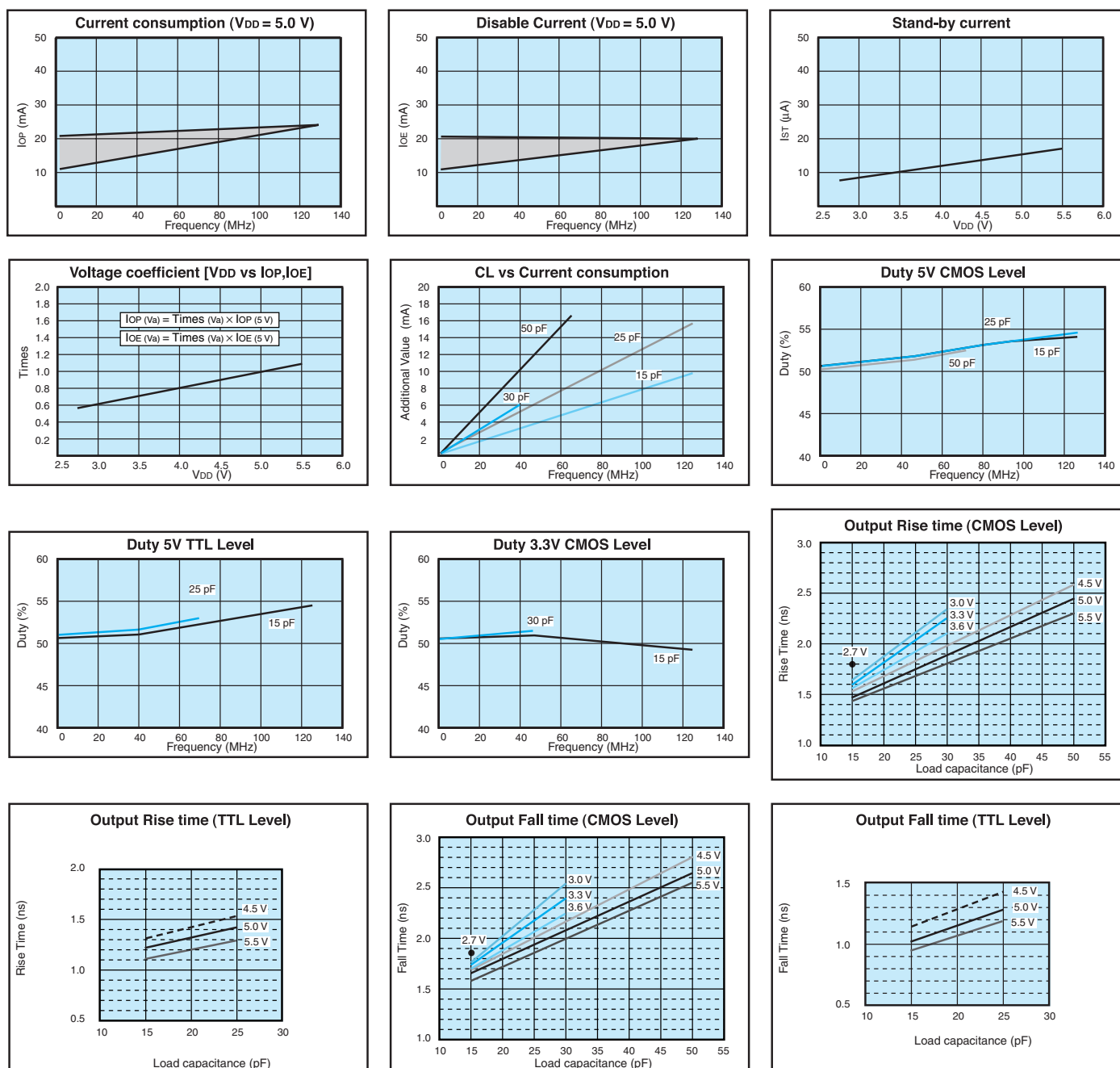

# FOR SG-8002 SERIES PROGRAMMING TOOL

# SG-WRITER

Product number

**Q91PR20W0101000**

- Easy frequency program for EPSON SG-8002 series oscillator (Blank oscillator).
- Free power supply for USB accommodate.
- Flexible PC accommodate.  
Windows 98SE, 2000, Me, XP (Except Windows 95, NT)
- Small body and easy carry.

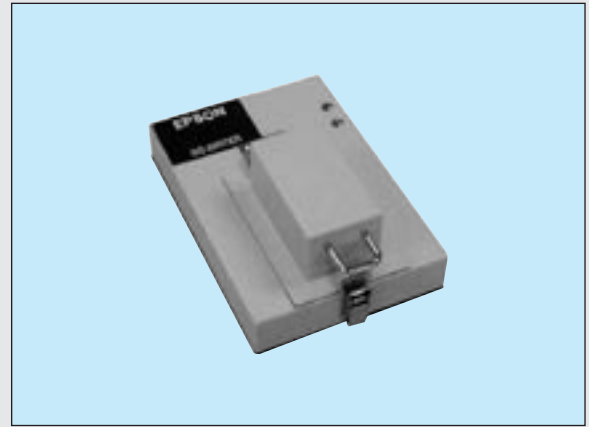

## ■ Main Body Specifications

Name (Product Number)	SG-Writer for EPSON SG-8002 Series (Q91PR20W0101000)
Operating Temperature	+10 °C to +40 °C Writing (25 °C ±5 °C)
Electric Power Supply	Via USB
Standard Interface	USB Type B
External Dimensions (mm)	160 x 110 x 36 (textool top)
Wight	700 g
Accessories	SG-Writer CD-ROM (Software and Instruction Manual : Japanese, English) Documents : Japanese, English
Software, Driver	SG-Writer *1 EPSON USB Driver
Option Parts	SMD socket (JA, JC, CA, JF, CE, LA and LB type)

\*1 SG-Writer software is available only from Epson website after user registration. [http://www.epsondevice.com/qd\\_e/SG-8002CS](http://www.epsondevice.com/qd_e/SG-8002CS)

## ■ Recommend PC Specifications (Need connect PC and SG-Wrier when you Writing.)

Accommodate OS	Windows XP, Windows Me, Windows 2000, Windows 98SE (Except Windows 95, NT)
Recommend CPU	Pentium Processor 200MHz equivalent and higher
Recommend memory Capacity	Recommend Over 64MB
Recommend HDD Capacity	Need Over 40MB
Other	CD-ROM drive, USB cable (Type A ↔ Type B) Need SMD *2 socket when you write SG-8002 SMD products. (Sold individually)

\*2 Conventional SMD socket can be used with new SG-Writer.

# THE CRYSTALMASTER



## ENERGY SAVING EPSON

EPSON offers effective savings to its customers through a wide range of electronic devices, such as semiconductors, liquid crystal display (LCD) modules, and crystal devices. These savings are achieved through a sophisticated melding of three different efficiency technologies.

Power saving technology provides low power consumption at low voltages.

Space saving technology provides further reductions in product size and weight through super-precise processing and high-density assembly technology.

Time saving technology shortens the time required for design and development on the customer side and shortens delivery times.

Our concept of Energy Saving technology conserves resources

by blending the essence of these three efficiency technologies. The essence of these technologies is represented in each of the products that we provide to our customers.

In the industrial sector, leading priorities include measures to counter the greenhouse effect by reducing CO<sub>2</sub>, measures to preserve the global environment, and the development of energy-efficient products. Environmental problems are of global concern, and although the contribution of energy-saving technology developed by EPSON may appear insignificant, we seek to contribute to the development of energy-saving products by our customers through the utilization of our electronic devices. EPSON is committed to the conservation of energy, both for the sake of people and of the planet on which we live.

### WORKING WITH ENVIRONMENTAL ISSUES

In 1988, Seiko Epson led in working to abolish CFCs, and perfect abolition of those ozone layer-destroying substances was achieved in 1992. In 1998, the 10th year of start of the CFC-free activity, Seiko Epson set this year as the "Second Environmental Benchmark Year" and established a new corporate General Environmental Policy. Seiko Epson is tackling with environmental issues comprehensively.

At the end of Fiscal 1988, Seiko Epson succeeded in abolishing chloric solvents doubted to be harmful to human body. In fiscal 1999, Seiko Epson started the activity with a goal of abolishing lead solder pointed out possibility of environmental pollutant.

### Promotion of Environment Management System conforming to International Standard

To strengthen management for environmental activities, Seiko Epson Group aims at acquisition of the ISO14001 certification for Japanese and abroad main business bases (including affiliates) for manufacturing, sales, software development and others.

As of May 25, 2001, planned 68 bases of all manufacturing bases and some non-manufacturing bases have acquired the certification.



### Co-existence Mark

The environmental mark symbolizing Epson's basic stance of "Co-existence with Nature". The design incorporates a fish, flower, and water, representing mutually supportive co-existence.



ISO14000 is an international standard for environmental management that was established by the International Standards Organization in 1996 against the background of growing concern regarding global warming, destruction of the ozone layer, and global deforestation.

### WORKING FOR HIGH QUALITY

Seiko-Epson quickly began working to acquire company-wide ISO9000 series certification, and has acquired ISO9001 or ISO9002 certification with all targeted products manufactured in Japanese and overseas plants.

The Quartz Device Operations Division (Ina Japan, EPM and SZE) have acquired QS-9000 certification, which are of higher level.



### QS-9000:

This is an enhanced standard for quality assurance systems formulated by leading U.S. automobile manufacturers based on the international ISO 9000 series.

### NOTICE

- The material is subject to change without notice.
- Any part of this material may not be reproduced or duplicated in any form or any means without the written permission of Seiko Epson.
- The information, applied circuit, program, using way etc., written in this material is just for reference. Seiko Epson does not assume any liability for the occurrence of infringing any patent or copyright of third party. This material does not authorize the licence for any patent or intellectual property rights.
- Any product described in this material may contain technology or the subject relating to strategic products under the control of the Foreign Exchange and Foreign Trade Law of Japan and may require an export licence from the Ministry of International Trade and industry or other approval from another government agency.
- The products (except for some product for automotive applications) listed up on this material are designed to be used with ordinary electronic equipment (OA equipment, AV equipment, communications equipment, measuring instruments etc). Seiko Epson does not assume any liability for the case using the products with the application required high reliability or safety extremely (such as aerospace equipment etc). When intending to use any our product with automotive application and the other application than ordinary electronic equipments as above, please contact our sales representatives in advance.