

Programmable Controller

MELSEC iQ-R
series

MELSEC iQ-R

Online Module Change Manual

SAFETY PRECAUTIONS

(Read these precautions before using this product.)

Before using MELSEC iQ-R series programmable controllers, please read the manuals for the product and the relevant manuals introduced in those manuals carefully, and pay full attention to safety to handle the product correctly. Make sure that the end users read this manual and then keep the manual in a safe place for future reference.

CONDITIONS OF USE FOR THE PRODUCT

- (1) Mitsubishi programmable controller ("the PRODUCT") shall be used in conditions;
- i) where any problem, fault or failure occurring in the PRODUCT, if any, shall not lead to any major or serious accident; and
 - ii) where the backup and fail-safe function are systematically or automatically provided outside of the PRODUCT for the case of any problem, fault or failure occurring in the PRODUCT.
- (2) The PRODUCT has been designed and manufactured for the purpose of being used in general industries. MITSUBISHI SHALL HAVE NO RESPONSIBILITY OR LIABILITY (INCLUDING, BUT NOT LIMITED TO ANY AND ALL RESPONSIBILITY OR LIABILITY BASED ON CONTRACT, WARRANTY, TORT, PRODUCT LIABILITY) FOR ANY INJURY OR DEATH TO PERSONS OR LOSS OR DAMAGE TO PROPERTY CAUSED BY the PRODUCT THAT ARE OPERATED OR USED IN APPLICATION NOT INTENDED OR EXCLUDED BY INSTRUCTIONS, PRECAUTIONS, OR WARNING CONTAINED IN MITSUBISHI'S USER, INSTRUCTION AND/OR SAFETY MANUALS, TECHNICAL BULLETINS AND GUIDELINES FOR the PRODUCT.

("Prohibited Application")

Prohibited Applications include, but not limited to, the use of the PRODUCT in;

- Nuclear Power Plants and any other power plants operated by Power companies, and/or any other cases in which the public could be affected if any problem or fault occurs in the PRODUCT.
- Railway companies or Public service purposes, and/or any other cases in which establishment of a special quality assurance system is required by the Purchaser or End User.
- Aircraft or Aerospace, Medical applications, Train equipment, transport equipment such as Elevator and Escalator, Incineration and Fuel devices, Vehicles, Manned transportation, Equipment for Recreation and Amusement, and Safety devices, handling of Nuclear or Hazardous Materials or Chemicals, Mining and Drilling, and/or other applications where there is a significant risk of injury to the public or property.

Notwithstanding the above, restrictions Mitsubishi may in its sole discretion, authorize use of the PRODUCT in one or more of the Prohibited Applications, provided that the usage of the PRODUCT is limited only for the specific applications agreed to by Mitsubishi and provided further that no special quality assurance or fail-safe, redundant or other safety features which exceed the general specifications of the PRODUCTS are required. For details, please contact the Mitsubishi representative in your region.

INTRODUCTION

Thank you for purchasing the Mitsubishi Electric MELSEC iQ-R series programmable controllers.

This manual describes the online module change, which allows a module to be changed without stopping the system for MELSEC iQ-R series programmable controllers.

Before using this product, please read this manual and the relevant manuals carefully and develop familiarity with the functions and performance of the MELSEC iQ-R series programmable controller to handle the product correctly.

When applying the program and circuit examples provided in this manual to an actual system, ensure the applicability and confirm that it will not cause system control problems.

Please make sure that the end users read this manual.

MEMO

CONTENTS

SAFETY PRECAUTIONS	1
CONDITIONS OF USE FOR THE PRODUCT	1
INTRODUCTION	1
RELEVANT MANUALS	4
TERMS	5
CHAPTER 1 OVERVIEW	6
CHAPTER 2 SYSTEM CONFIGURATION	8
2.1 Configuration Devices	8
2.2 Restrictions on System Configuration	10
2.3 Precautions for System Configuration	11
CHAPTER 3 REPLACEMENT PROCEDURE	13
3.1 Specifications	13
Specifications of the redundant system	21
Specifications of each module	21
3.2 Restrictions on Replacement Procedures	27
3.3 Precautions for Replacement Procedures	28
3.4 Changing a Module by Controlling Special Relays and Special Registers	29
3.5 Changing a Module Directly	43
CHAPTER 4 TROUBLESHOOTING	50
4.1 Error Processing and Recovery Methods	50
4.2 Troubleshooting by Symptom	51
INDEX	54
REVISIONS	56
WARRANTY	57
TRADEMARKS	58

RELEVANT MANUALS

Manual name [manual number]	Description	Available form
MELSEC iQ-R Online Module Change Manual [SH-081501ENG] (this manual)	Online module change, which allows a module to be changed without stopping the system for MELSEC iQ-R series programmable controllers	Print book e-Manual PDF
MELSEC iQ-R CPU Module User's Manual (Application) [SH-081264ENG]	Memory, functions, devices, and parameters of the CPU module	Print book e-Manual PDF
MELSEC iQ-R CC-Link IE Field Network Remote Head Module User's Manual (Application) [SH-081616ENG]	Functions, parameter settings, and troubleshooting of the CC-Link IE Field Network remote head module	Print book e-Manual PDF



e-Manual refers to the Mitsubishi FA electronic book manuals that can be browsed using a dedicated tool.

e-Manual has the following features:

- Required information can be cross-searched in multiple manuals.
- Other manuals can be accessed from the links in the manual.
- The hardware specifications of each part can be found from the product figures.
- Pages that users often browse can be bookmarked.
- Sample programs can be copied to an engineering tool.

TERMS

Unless otherwise specified, this manual uses the following terms.

Term	Description
A/D converter module	A generic term for the MELSEC iQ-R series analog-digital converter module, channel isolated analog-digital converter module, and high speed analog-digital converter module
Backup mode	A mode for normal operation in a redundant system
C intelligent function module	A generic term for the MELSEC iQ-R series C intelligent function module
Control CPU	A CPU module that controls connected I/O modules and intelligent function modules. The multiple CPU system allows the user to assign this control to any CPU module on a module-by-module basis.
Control system	A system that takes control and performs network communications in a redundant system
CPU module	A generic term for the MELSEC iQ-R series CPU module
D/A converter module	A generic term for the MELSEC iQ-R series digital-analog converter module, channel isolated digital-analog converter module, and high speed digital-analog converter module
Dedicated instruction	An instruction that facilitates the programming to use the functions of a module
Engineering tool	A tool used for setting up programmable controllers, programming, debugging, and maintenance. For the compatible tools, refer to the following.  MELSEC iQ-R Module Configuration Manual
Flexible high-speed I/O control module	The abbreviation for the MELSEC iQ-R series flexible high-speed I/O control module
High speed data logger module	A generic term for the MELSEC iQ-R series high speed data logger module
High-speed counter module	The abbreviation for the MELSEC iQ-R series high-speed counter module
I/O module	A generic term for the MELSEC iQ-R series input module, output module, and I/O combined module
Intelligent function module	A generic term for the module that has functions other than input and output, such as an A/D converter module and D/A converter module
MES interface module	A generic term for the MELSEC iQ-R series MES interface module
Multiple CPU system	A system where two to four CPU modules separately control I/O modules and intelligent function modules
OPC UA server module	The abbreviation for the MELSEC iQ-R series OPC UA server module
Positioning module	The abbreviation for the MELSEC iQ-R series positioning module
Process CPU	A generic term for the R08PCPU, R16PCPU, R32PCPU, and R120PCPU
Redundant function module	Another term for the R6RFM. This module is used with the Process CPU (redundant mode) as a pair and configures a redundant system.
Redundant system	A system consisting of two systems that have same configuration (CPU module, power supply module, network module, and other modules). Even after an error occurs in one of the two system, the other system takes over the control of the entire system.
Remote head module	The abbreviation for the RJ72GF15-T2 CC-Link IE Field Network remote head module
Separate mode	A mode for system maintenance in a redundant system. This mode can maintain a redundant system without stopping control while the system is running.
Simple motion module	The abbreviation for the MELSEC iQ-R series simple motion module
Single CPU system	A system where one CPU module serves to control I/O modules and intelligent function modules
Standby system	A backup system in a redundant system
Temperature control module	The abbreviation for the MELSEC iQ-R series temperature control module
Temperature input module	A generic term for the MELSEC iQ-R series channel isolated thermocouple input module and channel isolated RTD input module

1 OVERVIEW

The online module change function allows users to replace the module mounted on a main base unit or an extension base unit with a new module controlling the system while the power is on (online).

The online module change function allows users to replace the module that malfunctioned during control with a module having the same model as that of the malfunctioning module.

Select one of the following methods to use the online module change function.

- Changing a module using special relays and special registers
- Changing a module directly

Changing a module using special relays and special registers

Replace the target module with a new one by operating special relays and special registers of the control CPU from an external device (such as a GOT). Controls can be started and stopped at the desired timing.

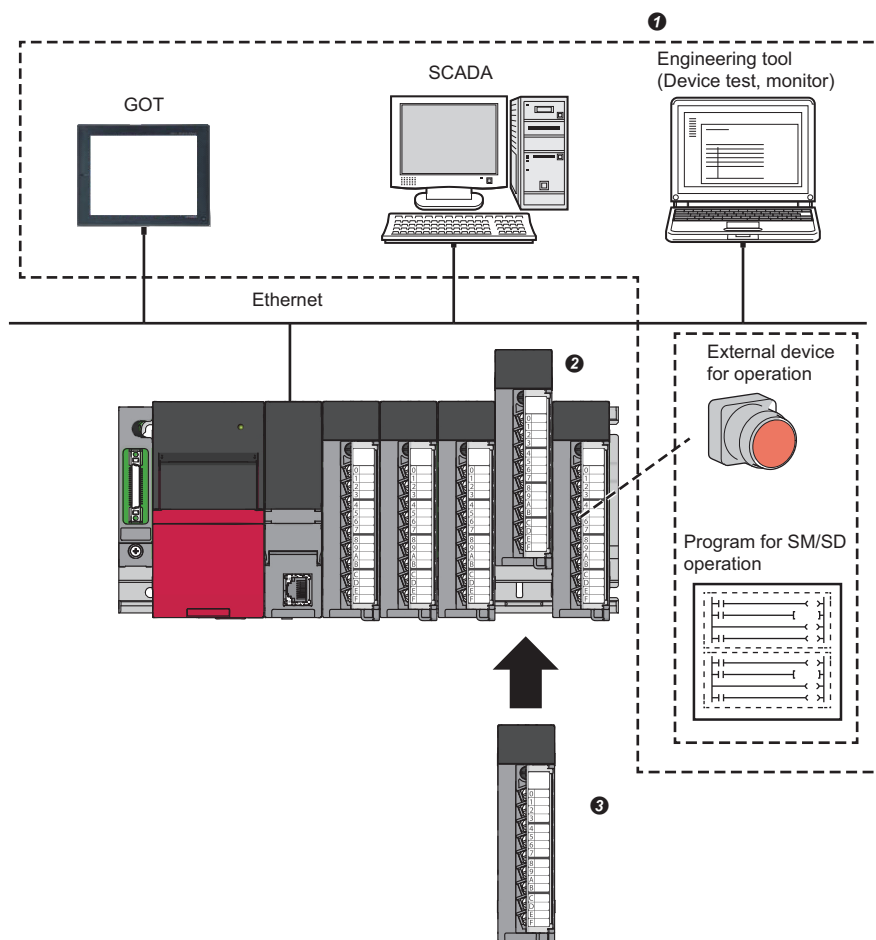

- 1 Operate special relays and special registers from an engineering tool, a GOT, or an external device for operation.
- 2 Remove the replacement target module.
- 3 Mount a new module.

For details, refer to the following.

☞ Page 29 Changing a Module by Controlling Special Relays and Special Registers

Changing a module directly

By setting parameters in advance, the target module can be replaced with a new one without using the engineering tool or external devices. No operations for special relays or special registers are required. Thus, the module can be replaced easily.

1

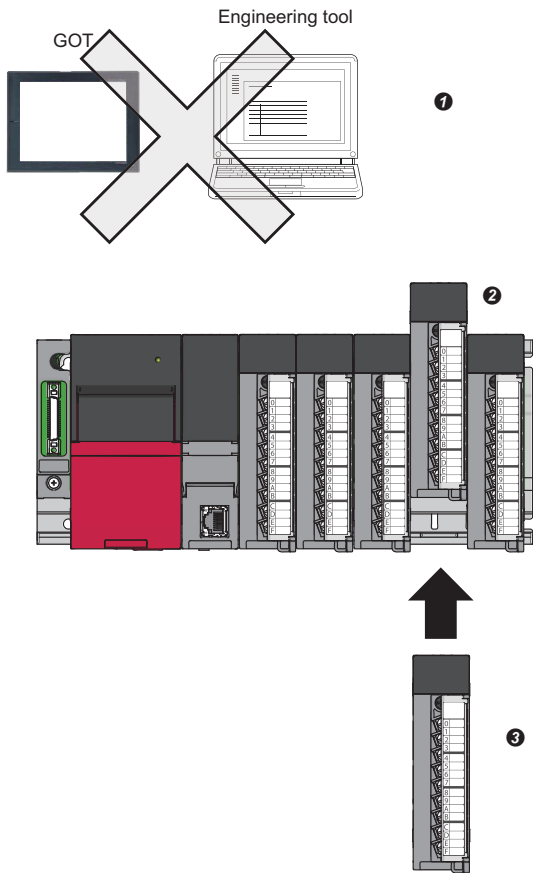

- ❶ Do not operate special relays or special registers.
- ❷ Remove the replacement target module.
- ❸ Mount a new module.

For details, refer to the following.

📖 Page 43 Changing a Module Directly

2 SYSTEM CONFIGURATION

This chapter describes the system configuration to perform the online module change.

2.1 Configuration Devices

The following shows the modules and engineering tool that support the online module change.

CPU module

In the single CPU system, the online module change can be performed only when the system is configured using the Process CPU.

To perform the online module change in the multiple CPU system, all the CPU modules in the system should be the Process CPU.

Remote head module

The online module change can be performed when the system is configured using a remote head module.

Only direct change is available as a method of the online module change when a redundant system is configured using a remote head module.

Engineering tool

Use an engineering tool of the version supported by the CPU module used, the remote head module used, and the module to be replaced. For the supported version of engineering tools, refer to the following.

 GX Works3 Operating Manual

Modules that support the online module change

The following table lists the modules that support the online module change.

Module		Model	Remarks
CPU module extension	Redundant function module ^{*1}	R6RFM	—
I/O modules	AC input module	RX10, RX28	—
	DC input module	RX40C7, RX41C4, RX42C4	
	DC high-speed input module	RX40PC6H, RX40NC6H, RX41C6HS, RX61C6HS	
	Input module with diagnostic functions	RX40NC6B	
	Contact output module	RY10R2, RY18R2A	
	Triac output module	RY20S6	
	Transistor output module	RY40NT5P, RY41NT2P, RY42NT2P, RY40PT5P, RY41PT1P, RY42PT1P	
	Transistor high-speed output module	RY41NT2H, RY41PT2H	
	Output module with diagnostic functions	RY40PT5B	
	I/O combined module	RH42C4NT2P	
Intelligent function modules	Analog-digital converter module	R60AD4, R60ADi8, R60ADV8	The supported firmware version is "02" or later.
	Channel isolated analog-digital converter module	R60AD8-G, R60AD16-G	—
	High speed analog-digital converter module	R60ADH4	—
	Digital-analog converter module	R60DA4, R60DAi8, R60DAV8	The supported firmware version is "02" or later.
	Channel isolated digital-analog converter module	R60DA8-G, R60DA16-G	—
	High speed digital-analog converter module	R60DAH4	—
	Channel isolated thermocouple input module	R60TD8-G	—
	Channel isolated RTD input module	R60RD8-G	—
	Temperature control module	R60TCRT2TT2, R60TCRT4, R60TCRT2TT2BW, R60TCRT4BW	—
	Simple motion module	RD77MS2, RD77MS4, RD77MS8, RD77MS16	The supported firmware version is "03" or later.
	High-speed counter module	RD62P2, RD62D2, RD62P2E	—
	Flexible high-speed I/O control module	RD40PD01	—
	Positioning module	RD75P2, RD75P4, RD75D2, RD75D4	The supported firmware version is "02" or later.
	MES interface module	RD81MES96	The supported firmware version is "03" or later.
	High speed data logger module	RD81DL96	—
	C intelligent function module	RD55UP06-V	—
	OPC UA server module	RD81OPC96	—

*1 The direct change is not available for this module as a method of the online module change. Replace this module using special relays and special registers.



The online module change cannot be performed on the MELSEC-Q series modules mounted on the RQ extension base unit or the MELSEC-Q series extension base unit.

2.2 Restrictions on System Configuration

This section describes the restrictions on the system configuration.

- When 'Online module change availability flag' (SM1616) of the CPU module or remote head module is OFF (0), the online module change cannot be performed. Before performing the online module change, check that 'Online module change availability flag' (SM1616) is ON (1). In the multiple CPU system, 'Online module change availability flag' (SM1616) becomes ON (1) when all the CPU modules support the online module change. However, the setting details of the direct change setting cannot be checked with 'Online module change availability flag' (SM1616). To check the direct change setting, check the CPU parameter.
- In the multiple CPU system, the combined use of the Process CPU (with the setting to enable the direct change) and CPU modules other than the Process CPU results in an error. (📖 MELSEC iQ-R Module Configuration Manual)
- When a module controlled by other CPU modules is accessed in the multiple CPU system, performing online module change on the module causes the access to stop. The following shows the accesses to be stopped.
 - FROM instruction
 - Direct access input (DX)
 - Instruction that uses a module access device (Un\G□)
 - Importing an input (X) or an output (Y)
- For the modules that are set to an empty slot in "I/O Assignment Setting" of the system parameters, online module change is not permitted.
- For the modules that are set as the synchronous target module in "Inter-module Synchronization Setting" of the system parameters, online module change is not permitted.
- Only direct change is available as a method of the online module change when a redundant system is configured using a remote head module. The LEDs, SM/SD, and error codes can be checked with the control system remote head module.

2.3 Precautions for System Configuration

This section describes the precautions for the system configuration.

- For the module to be prepared for online module change, check the following in advance:
 - The new module to be mounted has the same model name as the replacement target module.
 - The firmware version of the mounted module supports the online module change.
 - The new module to be mounted has no failure.
- In the multiple CPU system, when any of the CPU modules is set to "Enable" in "Direct change setting" (including the case where other CPU modules are set to "Disable" in "Direct change setting"), there is a possible error where the operation of all the CPU modules does not stop but continue ( Page 43 When "Direct change setting" is set to "Enable"). When configuring a system, verify that the system is not affected if the operation continues in spite of the error.
- For the external power supply of the module on which online module change is to be performed, and the power supply of external devices, provide a means of turning off the power separately with a switch or other devices to prevent an electric shock or malfunction of the module in operation.
- The recommendation before the checks listed below is to perform online module change in advance on the actual system to verify that there is no influence on the operation of the modules that are not subject to replacement.
 - There is no error in the means of turning off the connection to external devices, and its system configuration.
 - There is no influence caused by turning on or off a switch or other devices.
- An instruction that accesses the replacement target module (for example, the FROM instruction) may cause malfunction of the module during the online module change. Add an interlock as needed. The following shows how to provide an interlock with a module accessed by the FROM instruction in the event of online module change.

Ex.

An interlock to stop the FROM instruction to the target module when the online module change is performed on the target module while the FROM instruction is being executed to the module whose start I/O number is 0010H.

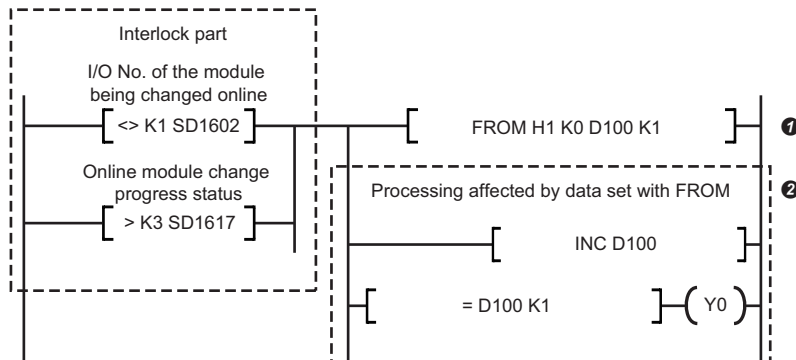

- ① Establishing the following two conditions results in the stop of the FROM instruction given to the module whose start I/O number is 0010H:
 - When 1 is stored in 'Online module changing module I/O No.' (SD1602)
 - When 3 (Module removal in preparation) or a larger value is stored in 'Online module changing status' (SD1617) (3 or a larger value is stored until the control of the module restarts from the state where module removal is allowed.)
- ② An interlock is provided as well in the processing that is affected by the data of the FROM instruction.

3 REPLACEMENT PROCEDURE

This chapter describes the procedures of online module change.

3.1 Specifications

This section describes the specifications of the online module change function.

- Here are the application and features of each method of online module change.

Replacement method	Application	Merit	Demerit
Changing a module by controlling special relays and special registers	Suitable to replace a module through an external device (such as GOT)	Controls can be started and stopped at the desired timing.	An external device (such as GOT) needs to be prepared.
Changing a module directly* ¹	Suitable to replace a module easily without any special operations	No special operations are required. Thus, the target module can be replaced easily.	<ul style="list-style-type: none"> • When the direct change is enabled, the system cannot judge whether the module has been accidentally removed or an online module change operation is in progress. • Until the removal of the module is detected, the scan time is longer than the scan time taken when the other method is used.

*1 The direct change is not available for redundant function modules as a method of the online module change.









- After the target module is replaced with a new module, the module-specific information is restored into the new module from the module-specific backup parameter saved in the CPU module or remote head module. This makes it possible to continue the same operation even after the replacement.
- Online module change of when the system is configured using a CPU module is permitted provided that there is no stop error. Even though the operating status of the CPU module is changed from RUN to STOP/PAUSE during online module change, the online module change is allowed to continue. However, when the CPU module is reset or a stop error occurs, the online module change is not able to continue.
- Online module change of when the system is configured using a remote head module is permitted provided that there is no moderate error or major error. Even though the operating status of the remote head module is changed from RUN to STOP during online module change, the online module change is allowed to continue. However, when the remote head module is reset or a moderate error or major error occurs, the online module change is not able to continue.

Operating status	Whether replacement is allowed or not
RUN	○
STOP	○
PAUSE	○
Initial	×
Reset	×
With a stop error occurring (CPU module)	×
With a moderate error or major error occurring (Remote head module)	×







Overall flow

Follow the following flow in each online module change:

■ Changing a module by controlling special relays and special registers

1. Checks before replacement ( Page 30 Checks before replacement)
 2. Module selection ( Page 33 Module selection)
 3. Module change activation ( Page 34 Module change activation)
 4. Module removal ( Page 35 Module removal)
 5. Module mounting ( Page 36 Module mounting)
 6. Module recognition ( Page 37 Module recognition)
 7. Module control start ( Page 39 Module control start)
- Before the completion of Step 3, the setting of module selection can be cancelled. ( Page 42 Cancel of module selection)

■ Changing a module directly

1. Presettings ( Page 43 Presettings)
2. Checks before replacement ( Page 43 Checks before replacement)
3. Module removal ( Page 44 Module removal)
4. Module mounting ( Page 45 Module mounting)
5. Module recognition ( Page 46 Module recognition)
6. Module control start ( Page 47 Module control start)

LED status

The following shows each LED status indicated at each step in online module change.

■ Changing a module by controlling special relays and special registers

[When the system is configured using a CPU module]

Step in online module change	Change in 'Online module changing status' (SD1617) *1	LED status on CPU module		LED status on target module *3
		READY LED	ERROR LED *2	RUN LED
Checks before replacement	0	ON	OFF	ON
Module selection	0 → 1 → 2	ON → Flashing (interval of 400ms)	OFF	ON → Flashing (interval of 400ms)
Module change activation	2 → 3 → 4 *4	Flashing (interval of 400ms)	OFF	Flashing (interval of 400ms) → OFF
Module removal	4 → 5	Flashing (interval of 400ms)	OFF	—
Module mounting	5 → 6	Flashing (interval of 400ms)	OFF	OFF
Module recognition	6 → 7 → 8	Flashing (interval of 400ms)	OFF	OFF → ON
Module control start	8 → 9 → 0	Flashing (interval of 400ms) → ON	OFF	ON

*1 The status of online module change is stored.

- 0: Normal operation
- 1: Module selection in progress
- 2: Module selection completion
- 3: Module removal in preparation
- 4: Module removal ready
- 5: Module removal completion
- 6: Module mounting completion
- 7: Module recognition in progress
- 8: Module recognition completion
- 9: Module control resumption in progress

*2 If a continuation error (the ERROR LED turns on) has occurred before online module change, the ERROR LED remains on during the module change.

*3 A failure in the module can cause the status to be different from the description above.

*4 A failure in the module can result in Module removal completion (5) instead of Module removal ready (4).

[When the system is configured using a remote head module]

Step in online module change	Change in 'Online module changing status' (SD1617)*1	LED status on remote head module		LED status on target module*3
		RUN LED	ERR LED*2	RUN LED
Checks before replacement	0	ON	OFF	ON
Module selection	0 → 1 → 2	ON → Flashing (interval of 400ms)	OFF	ON → Flashing (interval of 400ms)
Module change activation	2 → 3 → 4*4	Flashing (interval of 400ms)	OFF	Flashing (interval of 400ms) → OFF
Module removal	4 → 5	Flashing (interval of 400ms)	OFF	—
Module mounting	5 → 6	Flashing (interval of 400ms)	OFF	OFF
Module recognition	6 → 7 → 8	Flashing (interval of 400ms)	OFF	OFF → ON
Module control start	8 → 9 → 0	Flashing (interval of 400ms) → ON	OFF	ON

*1 The status of online module change is stored.

- 0: Normal operation
- 1: Module selection in progress
- 2: Module selection completion
- 3: Module removal in preparation
- 4: Module removal ready
- 5: Module removal completion
- 6: Module mounting completion
- 7: Module recognition in progress
- 8: Module recognition completion
- 9: Module control resumption in progress

*2 If a minor error (the ERR LED turns on) has occurred before online module change, the ERR LED remains on during the module change.

*3 A failure in the module can cause the status to be different from the description above.

*4 A failure in the module can result in Module removal completion (5) instead of Module removal ready (4).

■ Changing a module directly

[When the system is configured using a CPU module]

Step in online module change	Change in 'Online module changing status' (SD1617)*1	LED status on CPU module		LED status on target module*3
		READY LED	ERROR LED*2	RUN LED
Checks before replacement	0	ON	OFF	ON
Module removal	0 → 5	ON → Flashing (interval of 400ms)	OFF → ON*4	—
Module mounting	5 → 7	Flashing (interval of 400ms)	ON	OFF
Module recognition	7 → 9	Flashing (interval of 400ms)	ON	OFF → ON
Module control start	9 → 0	Flashing (interval of 400ms) → ON	ON → OFF*5	ON

*1 The status of online module change is stored.

0: Normal operation

1: Module selection in progress

2: Module selection completion

3: Module removal in preparation

4: Module removal ready

5: Module removal completion

6: Module mounting completion

7: Module recognition in progress

8: Module recognition completion

9: Module control resumption in progress

*2 If a continuation error (the ERROR LED turns on) has occurred before online module change, the ERROR LED remains on during the module change.

*3 A failure in the module can cause the status to be different from the description above.

*4 As a module is removed by means of the direct change, the CPU module enters the following state: the READY LED flashes; a module verification error occurs; and the ERROR LED turns on. Even though the direct change is completed successfully, the module verification error is not cleared and the ERROR LED remains on.

*5 Turning off the ERROR LED requires the error to be cleared by using the module diagnostics of the engineering tool or other means.

[When the system is configured using a remote head module]

Step in online module change	Change in 'Online module changing status' (SD1617)* ¹	LED status on remote head module		LED status on target module* ³
		RUN LED	ERR LED* ²	RUN LED
Checks before replacement	0	ON	OFF	ON
Module removal	0 → 5	ON → Flashing (interval of 400ms)	OFF → ON* ⁴	—
Module mounting	5 → 7	Flashing (interval of 400ms)	ON	OFF
Module recognition	7 → 9	Flashing (interval of 400ms)	ON	OFF → ON
Module control start	9 → 0	Flashing (interval of 400ms) → ON	ON → OFF* ⁵	ON

*1 The status of online module change is stored.

- 0: Normal operation
- 1: Module selection in progress
- 2: Module selection completion
- 3: Module removal in preparation
- 4: Module removal ready
- 5: Module removal completion
- 6: Module mounting completion
- 7: Module recognition in progress
- 8: Module recognition completion
- 9: Module control resumption in progress

*2 If a minor error (the ERR LED turns on) has occurred before online module change, the ERR LED remains on during the module change.

*3 A failure in the module can cause the status to be different from the description above.

*4 As a module is removed by means of the direct change, the remote head module enters the following state: the RUN LED flashes; a module verification error occurs; and the ERR LED turns on. Even though the direct change is completed successfully, the module verification error is not cleared and the ERR LED remains on.

*5 Turning off the ERR LED requires the error to be cleared by using the module diagnostics of the engineering tool or other means.

■How to check the ON state of 'Online module change error flag' (SM1618) with LEDs

An error in online module change causes 'Online module change error flag' (SM1618) to turn on and the error information to be stored in 'Online module change error code' (SD1618). However, the LED status does not change. To make the LED indicate the error, use an annunciator.*¹

*1 Remote head modules have no annunciators.

For the error information stored in 'Online module change error code' (SD1618), refer to the following.

 MELSEC iQ-R CPU Module User's Manual (Application)

■If an error irrelevant to online module change has occurred

An error irrelevant to online module change during online module change results in the following behavior of the LED status:

[When the system is configured using a CPU module]

- The ERROR LED shows the same behavior as in an error state.
- The READY LED flashes if a continuation error occurs. If a stop error occurs, the LED shows the same behavior as in an error state.

[When the system is configured using a remote head module]

- The ERR LED shows the same behavior as in an error state.
- The RUN LED flashes if a minor error occurs. If a moderate error or major error occurs, the LED shows the same behavior as in an error state.

Access to the module

The following shows the method for accessing each online module.

■ Changing a module by controlling special relays and special registers

- I/O modules

○: Executed, ×: Not executed

Procedure	I/O refresh		Direct access		FROM/TO instruction	Instruction using the module access device	Device test	Monitor
	Input (X)	Output (Y)	Input (DX)	Output (DY)				
Checks before replacement	○	○	○	○	○	○	○	○
Module selection	○	○	○	○	○	○	○	○
Module change activation	× ^{*1}	× ^{*1}	× ^{*1}	× ^{*1}	×	×	×	×
Module removal	× ^{*1}	× ^{*1}	× ^{*1}	× ^{*1}	×	×	×	×
Module mounting	× ^{*1}	× ^{*1}	× ^{*1}	× ^{*1}	×	×	×	×
Module recognition	× ^{*1}	× ^{*1}	× ^{*1}	× ^{*1}	×	×	○	○
Module control start	○	○	○	○	○	○	○	○

*1 The data is held.

- Intelligent function module

○: Executed, ×: Not executed

Procedure	I/O refresh		Module dedicated instruction	Intelligent auto refresh	Direct access		FROM/TO instruction	Instruction using the module access device	Device test	Monitor
	Input (X)	Output (Y)			Input (DX)	Output (DY)				
Checks before replacement	○	○	○	○	○	○	○	○	○	○
Module selection	○	○	○	○	○	○	○	○	○	○
Module change activation	× ^{*2}	× ^{*2}	×	×	×	×	×	×	×	×
Module removal	× ^{*2}	× ^{*2}	×	×	×	×	×	×	×	×
Module mounting	× ^{*2}	× ^{*2}	×	×	×	×	×	×	×	×
Module recognition	○	○	×	×	○	○	×	×	○	○
Module control start	○	○	○	○	○	○	○	○	○	○

*2 The data is held.

■ Changing a module directly

- I/O modules

○: Executed, ×: Not executed

Procedure	I/O refresh		Direct access		FROM/TO instruction	Instruction using the module access device	Device test	Monitor
	Input (X)	Output (Y)	Input (DX)	Output (DY)				
Checks before replacement	○	○	○	○	○	○	○	○
Module removal	×	×	×	×	×	×	×	×
Module mounting	×	×	×	×	×	×	×	×
Module recognition	×	×	×	×	×	×	○	○
Module control start	○	○	○	○	○	○	○	○

- Intelligent function module

○: Executed, ×: Not executed

Procedure	I/O refresh		Module dedicated instruction	Intelligent auto refresh	Direct access		FROM/TO instruction	Instruction using the module access device	Device test	Monitor
	Input (X)	Output (Y)			Input (DX)	Output (DY)				
Checks before replacement	○	○	○	○	○	○	○	○	○	○
Module removal	×	×	×	×	×	×	×	×	×	×
Module mounting	×	×	×	×	×	×	×	×	×	×
Module recognition	○	○	×	×	○	○	×	×	○	○
Module control start	○	○	○	○	○	○	○	○	○	○

Specifications of the redundant system

This section describes the specifications of online module change for the redundant system.

- Both in backup mode and in separate mode, online module change is permitted.
- Both in the control system and in the standby system, online module change is permitted.
- For the modules to which online module change can be performed in the redundant system, refer to the following.

📖 MELSEC iQ-R CPU Module User's Manual (Application)

- The output (Y) to the module being changed online will be held. However, in the redundant system, an output (Y) may turn off due to system switching or operation mode change during online module change. In this case, the output (Y) to the module being changed online also turns off.
- The online module change cannot be performed while the memory copy is being executed. Perform the online module change again after the memory copy is completed.
- In direct change, a continuation error may occur even if "RAS Setting" is set to choose a stop error, and this causes an error that the system is not switched. When performing a direct change as a method of the online module change, check that it does not affect the system. If it affects the system, perform the online module change using special relays and special registers instead of the direct change.

Specifications of each module

This section describes the specifications of online module change for each module.

Redundant function modules

■Precautions

- Performing online module change in the control system and the standby system simultaneously is not possible.
- After 'Module remove request flag' (SM1602) is turned on, the communication via the redundant function module stops until 'Module recognition request flag' (SM1606) is turned on. In addition, the systems remain in the system switching disable state until 'Module control resumption request flag' (SM1608) is commanded.
- In the system in which a redundant function module is being changed online, a new continuation error due to a tracking disable state is not detected from when 'Module recognition request flag' (SM1606) is turned on (regardless of whether the module is removed or not) until the control restarts. If the communication is disabled after the control restarts (the status switches to the normal processing), a continuation error due to a tracking disable state is detected. In the other system, a continuation error due to the communication disable state is detected if tracking is disabled.

I/O modules

■Module-specific backup parameter

The module-specific backup parameter is not provided, and thus no data is backed up.

I/O modules with diagnostic functions

■Module-specific backup parameter

The module-specific backup parameter is not provided, and thus no data is backed up.

A/D converter modules

■Restoration of the user range setting

Setting the following item to "Enable" allows the module-specific backup parameter (offset/gain value) in the CPU module or remote head module to be automatically restored upon module recognition. Thus, even without the use of dedicated instructions or other means, a newly replaced A/D converter module operates with the same user range setting as that of the old A/D converter module.

Setting the following item to "Disable" does not allow the offset/gain value to be automatically restored upon module recognition. When replacing the module with a new A/D converter module where the offset/gain setting is already set up, set the following item to "Disable" to perform online module change.

 [Navigation window] ⇒ [Parameter] ⇒ Target module ⇒ [Module Parameter] ⇒ [Application setting] ⇒ [Online module change] ⇒ [Auto restore of Offset/gain setting with the module change]

Point

Replacing the module with an A/D converter module where the offset/gain setting is already set up results in the mismatch of offset/gain values between the module-specific backup parameter of the CPU module or remote head module and the user range. After the replacement, update the module-specific backup parameter of the CPU module or remote head module. For the update method, refer to the User's Manual (Application) for each module.

■Q compatible mode

A module in operation in Q compatible mode also allows online module change. The newly replaced A/D converter module starts up in Q compatible mode.

■Operation mode

Online module change is permitted regardless of the mode set as the operation mode. After the replacement, the operation starts up with the settings of module parameters written in the CPU module or remote head module.

D/A converter modules

■Restoration of the user range setting

Setting the following item to "Enable" allows the module-specific backup parameter (offset/gain value) in the CPU module or remote head module to be automatically restored upon module recognition. Thus, even without the use of dedicated instructions or other means, a newly replaced D/A converter module operates with the same user range setting as that of the old D/A converter module.

Setting the following item to "Disable" does not allow the offset/gain value to be automatically restored upon module recognition. When replacing the module with a new D/A converter module where the offset/gain setting is already set up, set the following item to "Disable" to perform online module change.

 [Navigation window] ⇒ [Parameter] ⇒ Target module ⇒ [Module Parameter] ⇒ [Application setting] ⇒ [Online module change] ⇒ [Auto restore of Offset/gain setting with the module change]

Point

Replacing the module with a D/A converter module where the offset/gain setting is already set up results in the mismatch of offset/gain values between the module-specific backup parameter of the CPU module or remote head module and the user range. After the replacement, update the module-specific backup parameter of the CPU module or remote head module. For the update method, refer to the User's Manual (Application) for each module.

■Q compatible mode

A module in operation in Q compatible mode also allows online module change. The newly replaced D/A converter module starts up in Q compatible mode.

■Operation mode

Online module change is permitted regardless of the mode set as the operation mode. After the replacement, the operation starts up with the settings of module parameters written in the CPU module or remote head module.

Temperature input modules

■Restoration of the user range setting

Setting the following item to "Enable" allows the module-specific backup parameter (offset/gain value) in the CPU module or remote head module to be automatically restored upon module recognition. Thus, even without the use of dedicated instructions or other means, a newly replaced temperature input module operates with the same user range setting as that of the old temperature input module.

Setting the following item to "Disable" does not allow the offset/gain value to be automatically restored upon module recognition. When replacing the module with a new temperature input module where the offset/gain setting is already set up, set the following item to "Disable" to perform online module change.

 [Navigation window] ⇒ [Parameter] ⇒ Target module ⇒ [Module Parameter] ⇒ [Application setting] ⇒ [Online module change] ⇒ [Auto restore of Offset/gain setting with the module change]

Point

Replacing the module with a temperature input module where the offset/gain setting is already set up results in the mismatch of offset/gain values between the module-specific backup parameter of the CPU module or remote head module and the user range. After the replacement, update the module-specific backup parameter of the CPU module or remote head module. For the update method, refer to the User's Manual (Application) for each module.

■Q compatible mode

A module in operation in Q compatible mode also allows online module change. The newly replaced temperature input module starts up in Q compatible mode.

■Operation mode

Both in normal mode and in offset/gain setting mode, online module change is permitted. After the replacement, the operation starts up with the settings of module parameters written in the CPU module or remote head module.

Temperature control modules

■Q compatible mode

A module in operation in Q compatible mode also allows online module change. The newly replaced temperature control module starts up in Q compatible mode.

■Precautions

- Even if pre-recorded data are set to the buffer memory in the newly replaced module and control is restarted, the module cannot restart the control in the same control condition. The reason is because the settings of following areas are cleared when control is stopped.
 - 'CH□ Manipulated value (MV)' (buffer memory address: Un\G403, Un\G603, Un\G803, Un\G1003)
 - 'CH□ Manipulated value for heating (MVh)' (buffer memory address: Un\G403, Un\G603, Un\G803, Un\G1003)
 - 'CH□ Manipulated value for cooling (MVc)' (buffer memory address: Un\G408, Un\G608, Un\G808, Un\G1008)
- For example, if an upper limit alert with standby is set and the alert occurs before an online module change, the module goes into the standby state and the alert does not occur when the control is restarted after the online module change.
- Following are precautions for an online module change of the temperature control module where the multiple module interaction function is enabled.
 - When performing online module change of the temperature control module which is set as master, all the temperature control modules using the multiple module interaction function must be in the setting mode. Do not perform online module change while any temperature control module using multiple module interaction function is performing a control. If the online module change is performed, the module operation cannot be guaranteed.
 - When a online module change is performed to the temperature control module which is set as slave, the multiple module interaction function cannot be used. To enable the multiple module interaction function, reset the CPU module or remote head module, or turn on the power supply of all the temperature control modules using the multiple module interaction function again.

Simple Motion modules

■Module-specific backup parameter

The module-specific backup parameter is not provided, and thus no data is backed up.

■Backup and restoration of data in the module

Before starting online module change, carry out back up and restoration using the simple motion module setting function. Perform back up on the module that is subject to online module change; perform restoration on the new module to be mounted in online module change. For the restoration, prepare a separate system and perform restoration there. For the methods of backing up and restoring data in a module, refer to "Simple Motion Module Setting Help" of the engineering tool.

■Precautions

- Performing online module change while the simple motion module is in operation causes an axis error, which stops the operation. Before online module change, halt the operation and then make sure that the machines are not working.
- After turning on 'Module remove request flag' (SM1602), be sure to remove the simple motion module and mount the module. Otherwise, an error would occur in the CPU module or remote head module when 'Module recognition request flag' (SM1606) is turned on.

High-speed counter modules

■Module-specific backup parameter

The module-specific backup parameter is not provided, and thus no data is backed up.

Flexible high-speed I/O control module

■Restoration of hardware logic

Setting "Hardware logic control auto restoration executed/unexecuted" of the module parameter to "Enable" allows the module-specific backup parameter (hardware logic) in the CPU module to be automatically restored upon module recognition. Thus, a newly replaced flexible high-speed I/O control module operates with the same hardware logic as that of the old flexible high-speed I/O control module, without the hardware logic being written from the configuration tool.

Setting "Hardware logic control auto restoration executed/unexecuted" to "Disable" does not allow the hardware logic to be automatically restored upon module recognition. When replacing the module with a new flexible high-speed I/O control module where the hardware logic is already registered, set "Hardware logic control auto restoration executed/unexecuted" to "Disable" to perform online module change.

Point

Replacing the module with a flexible high-speed I/O control module where the hardware logic is already registered results in the mismatch between the module-specific backup parameter of the CPU module and the hardware logic in the flash ROM of the new flexible high-speed I/O control module. After the replacement, update the module-specific backup parameter of the CPU module. For the update method, refer to the User's Manual (Application) for each module.

Positioning modules

■Q compatible mode

A module in operation in Q compatible mode also allows online module change. The newly replaced positioning module starts up in Q compatible mode.

■Module-specific backup parameter

The module-specific backup parameter is not provided, and thus no data is backed up.

■Module parameter and module extension parameter

The module parameter and module extension parameter to be reflected to the new positioning module after online module change differ depending on the setting of "Extended parameter storage setting".

Parameter	Extension parameter storage setting	
	CPU	Positioning module
Module parameter	The module parameter of the CPU module or remote head module is reflected.	The module parameter of the CPU module or remote head module is reflected.
Module extension parameter	The module extension parameter of the CPU module or remote head module is reflected.	The module extension parameter of the positioning module is reflected.

Point

The recommendation for online module change is to set "Extended parameter storage setting" to "CPU". With the setting "CPU", the module extension parameter of the CPU module or remote head module is reflected, thus eliminating the need for writing the same settings as those of the old module into the new module with the engineering tool.

■Precautions

Performing online module change while the positioning module is in operation causes an axis error, which stops the operation. Before online module change, halt the operation and then make sure that the machines are not working.

MES interface module

■Module-specific backup parameter

The module-specific backup parameter is not provided, and thus no data is backed up.

■Precautions

Stop all communications of the MES Interface Function Configuration Tool to the module before executing the online module change, because when the online module change is executed, communication with the MES Interface Function Configuration Tool is also stopped. (Errors may occur in the MES Interface Function Configuration Tool.)

High speed data logger module

■Module-specific backup parameter

The module-specific backup parameter is not provided, and thus no data is backed up.

■Precautions

Stop all communications of the High Speed Data Logger Module Configuration Tool to the module before executing the online module change, because when the online module change is executed, communication with the High Speed Data Logger Module Configuration Tool is also stopped. (Errors may occur in the High Speed Data Logger Module Configuration Tool.)

C intelligent function module

■Module-specific backup parameter

The module-specific backup parameter is not provided, and thus no data is backed up.

■Backup and restoration of data in the module

- Note the setting contents of service/account settings of the engineering tool before starting the online module change. For the service/account settings on the new module to be mounted, prepare a separate system and set the settings in the separate system.
- Before starting online module change, carry out back up and restoration using the FTP client software. Perform back up on the module that is subject to online module change; perform restoration on the new module to be mounted in online module change. For the restoration, prepare a separate system and perform restoration there.

OPC UA server module

■Module-specific backup parameter

The module-specific backup parameter is not provided, and thus no data is backed up.

■Precautions

Stop all communications of the MX OPC UA Module Configurator-R and OPC UA client to the module before executing the online module change, because when the online module change is executed, communication with the MX OPC UA Module Configurator-R and OPC UA client is also stopped. (Errors may occur in the MX OPC UA Module Configurator-R and OPC UA client.)

3.2 Restrictions on Replacement Procedures

- When a module is removed directly while a module dedicated instruction is active, the completion status of the module dedicated instruction does not become Completed with an error.
- Replace one module at a time. Do not replace any other module during online module change. Doing so does not guarantee the operation of the mounted module. To recover from this, power off the programmable controller and replace the module.
- When performing online module change in the multiple CPU system, replace one module at a time in the entire multiple CPU system. Performing online module change on multiple modules simultaneously is not possible. Doing so does not guarantee the operation of the mounted module. To recover from this, power off the programmable controller and replace the module.
- During online module change, writing the system parameter, CPU parameter, and module parameter is not possible. Doing so causes an online module change error (error code: 4202H).
- Avoid online module change while parameters are being written. The online module change may not be completed successfully. This condition does not guarantee the operation of the mounted module.
- While the remote head module is being changed online, the standby system remote head module cannot be reset or mounted. Reset or mount the module after the online module change is completed.

3.3 Precautions for Replacement Procedures

- Before online module change, make sure that the systems outside the programmable controllers are free from malfunction.
- The precautions for mounting and removing a module are the same as the ones for mounting and removing a module on and from a base unit. (📖 MELSEC iQ-R Module Configuration Manual)
- For the precautions for operation and wiring of a module to be replaced, refer to the user's manual of each module.
- Changing a module directly during module access causes the module access to be interrupted. For example, performing online module change while the FROM instruction is in execution causes incomplete data retrieval. After the online module change is completed, execute the instruction again.
- With a module verification error occurring in direct change, one more verification error in another module is not recorded in the error history.
- When logging is in progress on a module access device, performing online module change on the logging target module yields a logged value of -1 during the module change. After the online module change is completed, the correct values are logged again.
- If the systems are switched while the remote head module is being changed online, the change continues on the new control system after the system switching. However, an error occurs on the new standby system. Reset it after the online module change.

3.4 Changing a Module by Controlling Special Relays and Special Registers

This section describes the method to replace a module using special relays and special registers. To replace a module using special relays and special registers, use the following special relays or special registers.

SM number, SD number	Name
SM1600	Module selection request flag
SM1601	Module selection completion flag
SM1602	Module remove request flag
SM1603	Module remove ready completion flag
SM1604	Module remove completion flag
SM1605	Module installation completion flag
SM1606	Module recognition request flag
SM1607	Module recognition completion flag
SM1608	Module control resumption request flag
SM1609	Online module change completion flag
SM1615	Module selection cancel request flag
SM1616	Online module change availability flag
SM1617	Online module changing flag
SM1618	Online module change error flag
SM1619	Online module changing disable request flag
SD1600	Module selection (base No.)
SD1601	Module selection (slot No.)
SD1602	Online module changing module I/O No.
SD1617	Online module changing status
SD1618	Online module change error code
SD1619	Online module changing disable request error code

For details on each special relay and special register, refer to the following.

 MELSEC iQ-R CPU Module User's Manual (Application)

 MELSEC iQ-R CC-Link IE Field Network Remote Head Module User's Manual (Application)

Checks before replacement

The following shows the check procedure before replacement. In this procedure, stop the control of the online module change target module for safe online module change.

■Redundant function modules

Check that a redundant function module in the other system is not being changed online.

■I/O modules

1. Stop all the outputs (Y) and inputs (X).
2. For an I/O module to which the external power supply is supplied, shut off the external power supply with a switch or other means.

■I/O modules with diagnostic functions

1. Stop all the outputs (Y) and inputs (X).
2. Shut off the external power supply with a switch or other means.

■A/D converter modules (for the R60AD4)

1. Set A/D conversion disable (1) in 'CH1 A/D conversion enable/disable setting' (Un\G500) of all the channels with an external device (such as a GOT).
2. Turn on and off 'Operating condition setting request' (Y9).
3. Turn off all the Y signals.
4. Check that the A/D conversion is stopped with 'A/D conversion completed flag' (Un\G42).

To replace other A/D converter modules, also stop the A/D conversion as above. For details on the I/O signals and buffer memory areas of each A/D converter module, refer to the User's Manual (Application) for the A/D converter module used.

■D/A converter modules (for the R60DA4)

1. Set D/A conversion disable (1) in 'CH1 D/A conversion enable/disable setting' (Un\G500) of all the channels with an external device (such as a GOT).
2. Turn on and off 'Operating condition setting request' (Y9).
3. Turn off all the Y signals.
4. Shut off the external power supply with a switch or other means.
5. Check that the D/A conversion is stopped and the analog output value is 0V/0mA.

To replace other D/A converter modules, also stop the D/A conversion as above. For details on the I/O signals and buffer memory areas of each D/A converter module, refer to the User's Manual (Application) for the D/A converter module used.

■Temperature input modules (for the R60TD8-G)

1. Set Conversion disable (1) in 'CH1 Conversion enable/disable setting' (Un\G500) of all the channels with an external device (such as a GOT).
2. Turn on and off 'Operating condition setting request' (Y9).
3. Turn off all the Y signals.
4. Check that the temperature conversion is stopped with 'Conversion completed flag' (Un\G42).

To replace other temperature input modules, also stop the temperature conversion as above. For details on the I/O signals and buffer memory areas of each temperature input module, refer to the User's Manual (Application) for the temperature input module used.

■Temperature control modules (for the R60TCTRT2TT2)

1. Set Stop (0) in 'PID continuation flag' (Un\G306) of all the channels with an external device (such as a GOT).
2. Turn on and off 'Setting/operation mode command' (Y1).
3. Turn off all the Y signals.
4. Check that the PID control is stopped with 'Setting/operation mode status' (X1).

To replace other temperature control modules, also stop the PID control as above. For details on the I/O signals and buffer memory areas of each temperature control module, refer to the User's Manual (Application) for the temperature control module used.

■Simple motion modules (for the RD77MS16)

1. Stop the operations of all the axes.
2. Turn off all the Y signals.

To replace other simple motion modules, also stop the control as above. For details on the I/O signals and buffer memory areas of each simple motion module, refer to the User's Manual (Application) for the simple motion module used.

■High-speed counter modules (for the RD62P2)

1. Turn off 'CH1 Count enable command (Y4)' and 'CH2 Count enable command (YC)' with an external device (such as a GOT).
2. Turn off 'CH1 PWM output start command (Y6)' and 'CH2 PWM output start command (YE)' when the PWM output function is used.
3. Turn off all the Y signals.

To replace other high-speed counter modules, also stop the control as above. For details on the I/O signals and buffer memory areas of each high-speed counter module, refer to the User's Manual (Application) for the high-speed counter module used.

■Flexible high-speed I/O control modules (for the RD40PD01)

1. Turn on 'Hardware logic control stop request' (Y5). Or perform [Online] ⇒ [Module operation] ⇒ [Hardware logic control Stop] from the configuration tool.
2. Turn off all the Y signals.

■Positioning modules (for the RD75P4)

1. Stop the positioning control of the positioning module with external stop signals or axis stop signals [Y4, Y5, Y6, and Y7] of each axis.
2. Configure settings in external devices so that the devices do not malfunction.
3. Turn off all the Y signals.

To replace other positioning modules, also stop the control as above. For details on the I/O signals and buffer memory areas of each positioning module, refer to the User's Manual (Application) for the positioning module used.

■MES interface module

1. Access to the SD memory card is stopped by using 'File access stop request' (Y3) or SD memory card access control switch.
2. Access to the MES interface module from the MES Interface Function Configuration Tool will stop.

■High speed data logger module

1. Stop file access process is executed by using the High Speed Data Logger Module Configuration Tool, the SD memory card access control switch, or 'File access stop request' (Y2).
2. Turn off all the Y signals.
3. Access to the high speed data logger module from the High Speed Data Logger Module Configuration Tool, GX LogViewer, or the FTP client software is stopped.

■C intelligent function module

1. Access to the Standard ROM and SD memory card from the user program is stopped.
2. Turn off all the Y signals.
3. Access to the C intelligent function module from the Telnet client software or FTP client software is stopped.

■OPC UA server module

1. Access to the SD memory card is stopped by using 'File access stop request' (Y3) or SD memory card access control switch.
2. Access to the OPC UA server module from the MX OPC UA Module Configurator-R and OPC UA client will stop.

Module selection

The following shows the procedure to select a module. In this procedure, select an online module change target module.

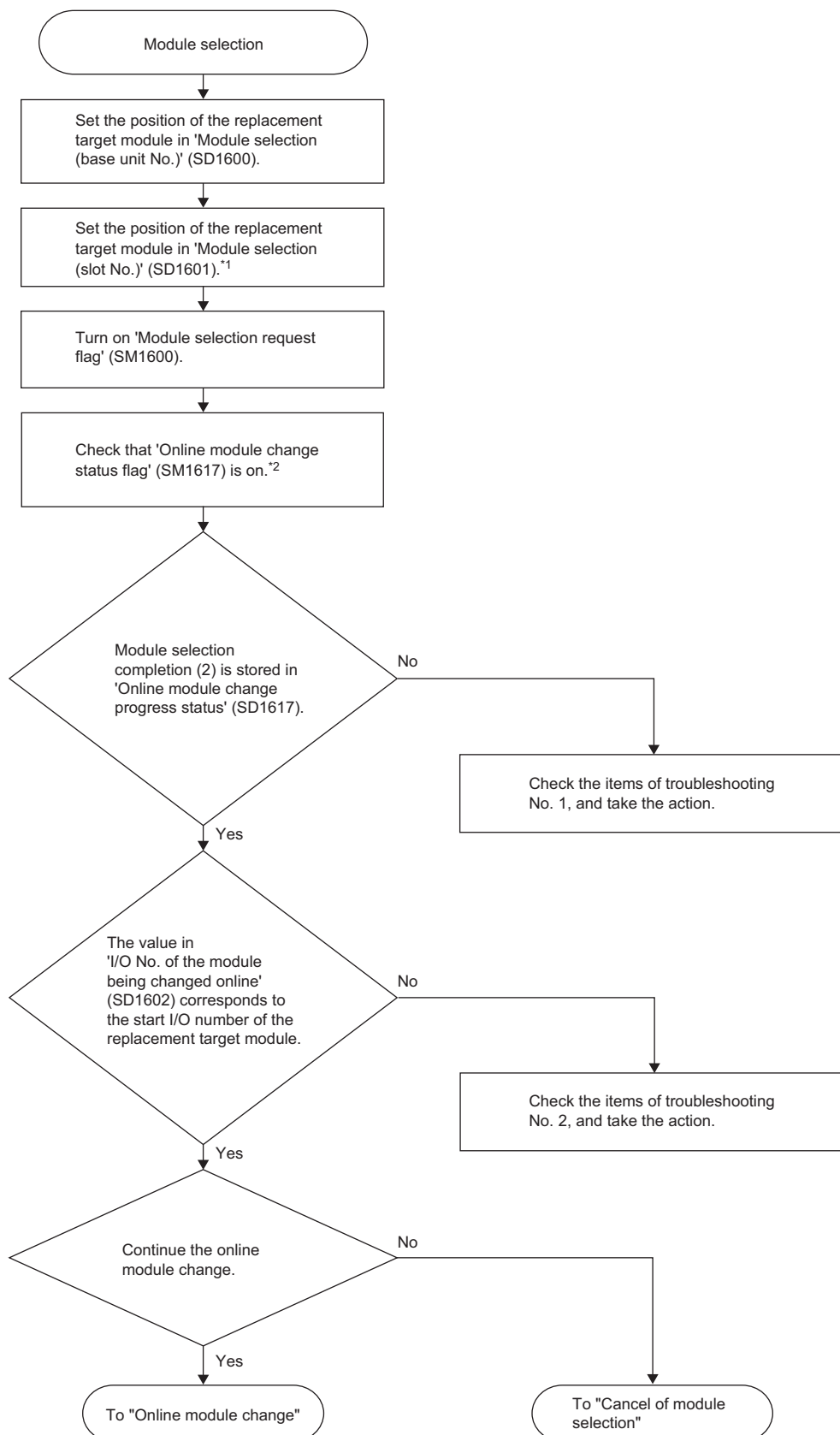

*1 To specify a two-slot occupied module, set the right-side slot number of the slots on which the module is mounted.

*2 The READY LED on the CPU module (RUN LED on the remote head module) and the RUN LED on the replacement target module flash (interval of 400ms). However, if the replacement target module has a failure, the RUN LED on the module may not flash. Perform the following operations to continue the online module change.

Module change activation

The following shows the procedure for module change activation. In this procedure, set the target module to be ready for online module change.

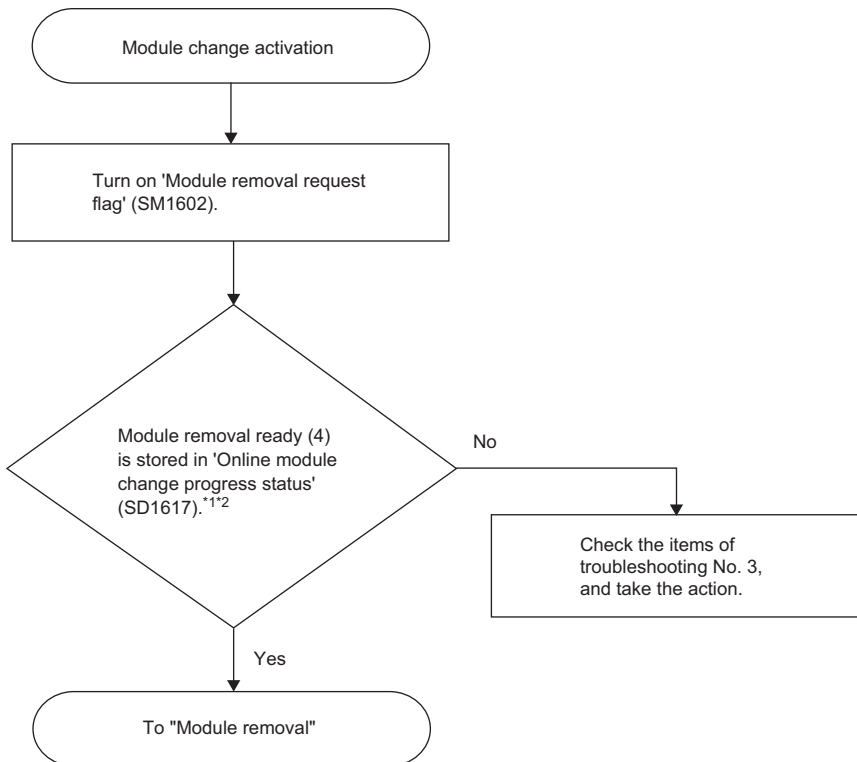

*1 For a positioning module, check also that the machine system is stopped.

*2 The RUN LED on the module turns off. However, if the replacement target module has a failure, the RUN LED on the module may not turn off and 'Online module changing status' (SD1617) may become Module removal completion (5). Perform the following operations to continue the online module change.

Module removal

The following shows the procedure to remove the module. In this procedure, remove the target module from the base unit.

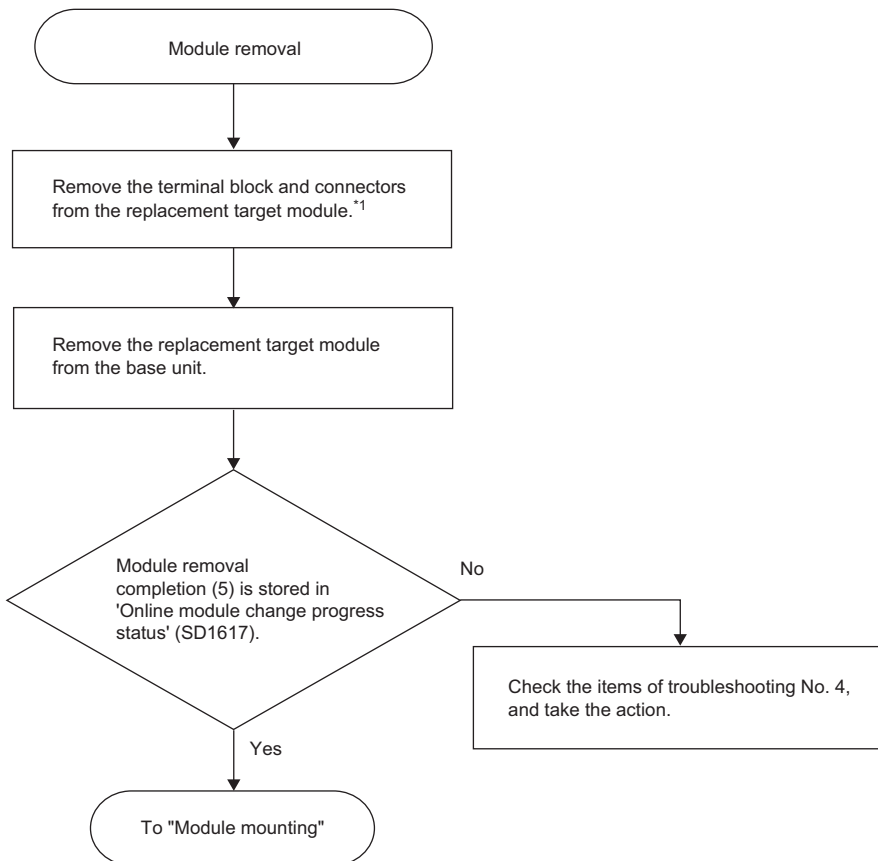

*1 Remove the SD memory card from the module to be replaced when MES interface module, high speed data logger module, C intelligent function module, and OPC UA server module are used.

Module mounting

The following shows the procedure to mount the module. In this procedure, mount the target module on the base unit.

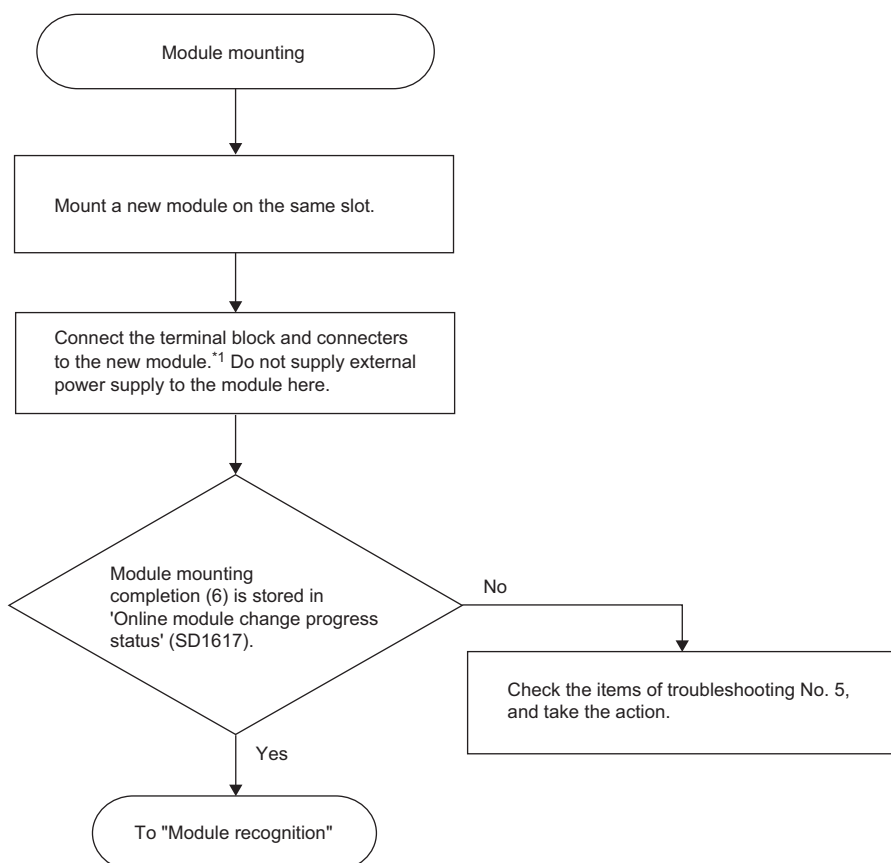

*1 Insert the SD memory card (which was removed when the module was removed) to a new module, if MES interface module, high speed data logger module, C intelligent function module, and OPC UA server module are used.

Module recognition

The following shows the procedure to recognize the module. In this procedure, make the system recognize the new module so that the system can control it.

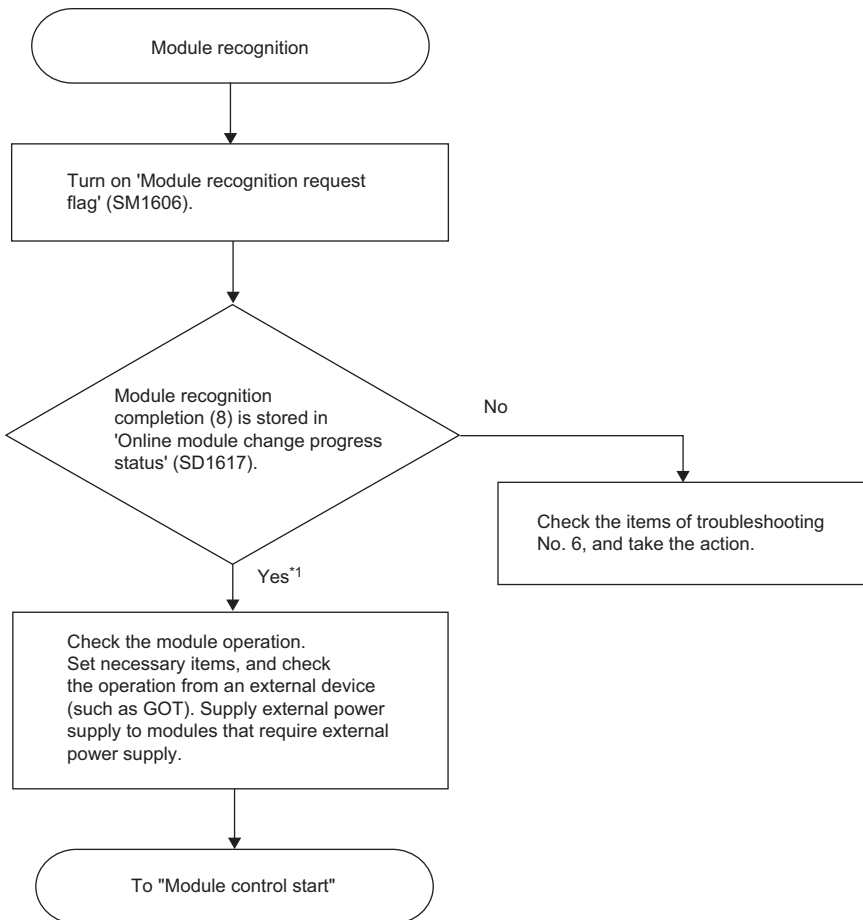

*1 When the initial setting is configured with the module parameter of an engineering tool, the setting of the module parameter is applied when the RUN LED turns on.

Initial setting for high-speed counter modules

'Module READY' (X0) turns on when the RUN LED on the high-speed counter module turns on. To execute the initial setting using a program, implement an interlock in the program as follows. Do not design a program that executes the initial setting only in one scan after the CPU module has started running. Otherwise, the initial setting is not executed.

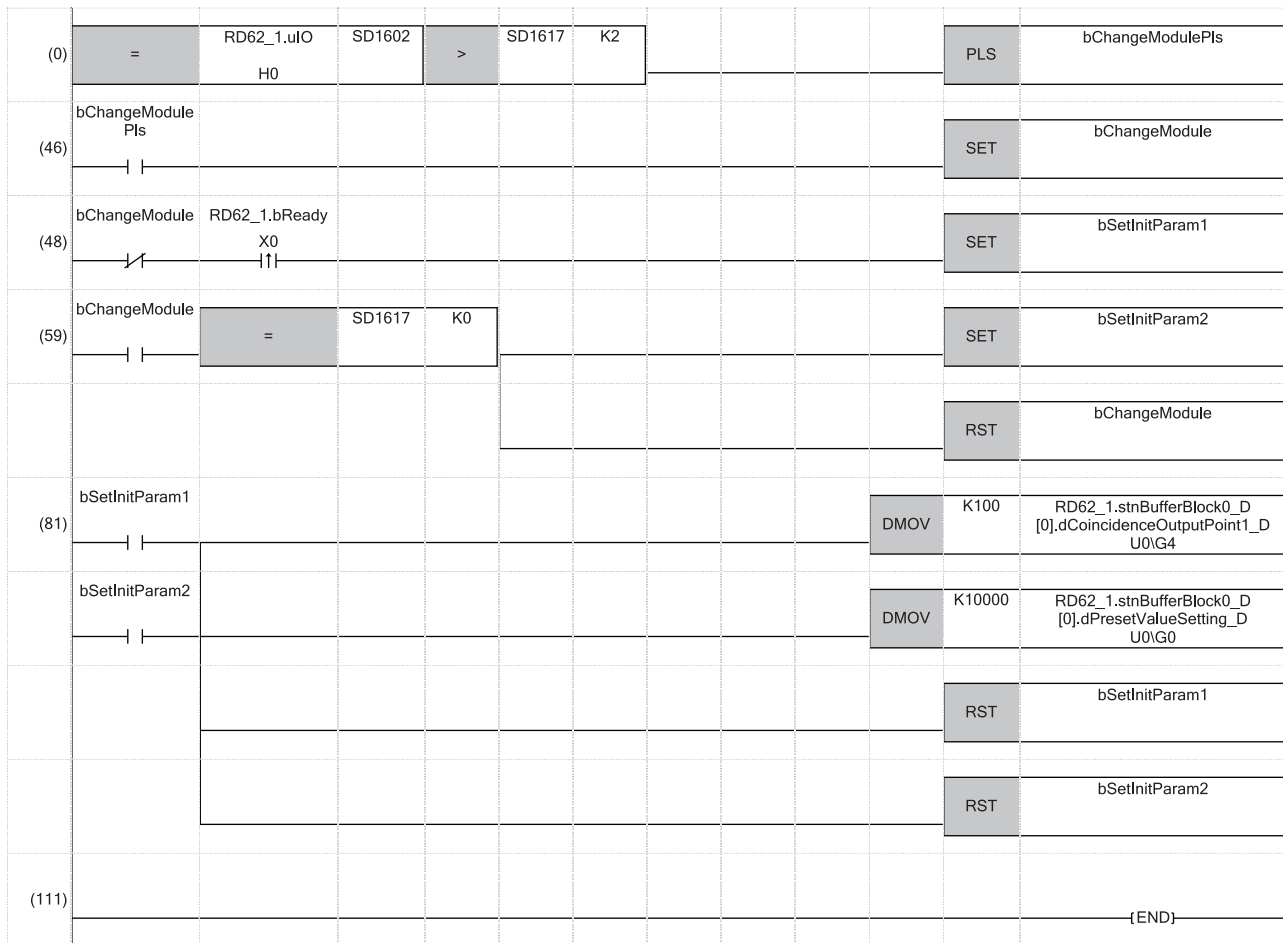

(0) Check the selection for an online module change.

(48) Check the power-on or STOP → RUN of the CPU module.

(59) Check that the online module change is completed.

(81) The steps are for the initial setting of a high-speed counter module. Design the steps so that required initial settings can be executed.

MES interface module

Check that the SD memory card or Ethernet cable is correctly inserted when an error occurs due to incorrectly inserted SD memory card or Ethernet cable. Clear the error with any of the following operations.

- Turn on 'Error clear request' (Y10).
- Execute error clear in the diagnostics window of the MES Interface Function Configuration Tool.

OPC UA server module

Check that the SD memory card or Ethernet cable is correctly inserted when an error occurs due to incorrectly inserted SD memory card or Ethernet cable. Clear the error with any of the following operations.

- Turn on 'Error clear request' (Y10).
- Update the setting from the MX OPC UA Module Configurator-R.

Module control start

The following shows the procedure to restart the module control. In this procedure, complete the online module change and restart the control of the new module. Before restarting the control of the module, check the following precautions.

■Precautions

- Make sure the new module is mounted completely and the module fixing hook is securely fixed.
- Make sure the connectors and terminal blocks connected to the module are free from looseness and rattles.

■Procedure

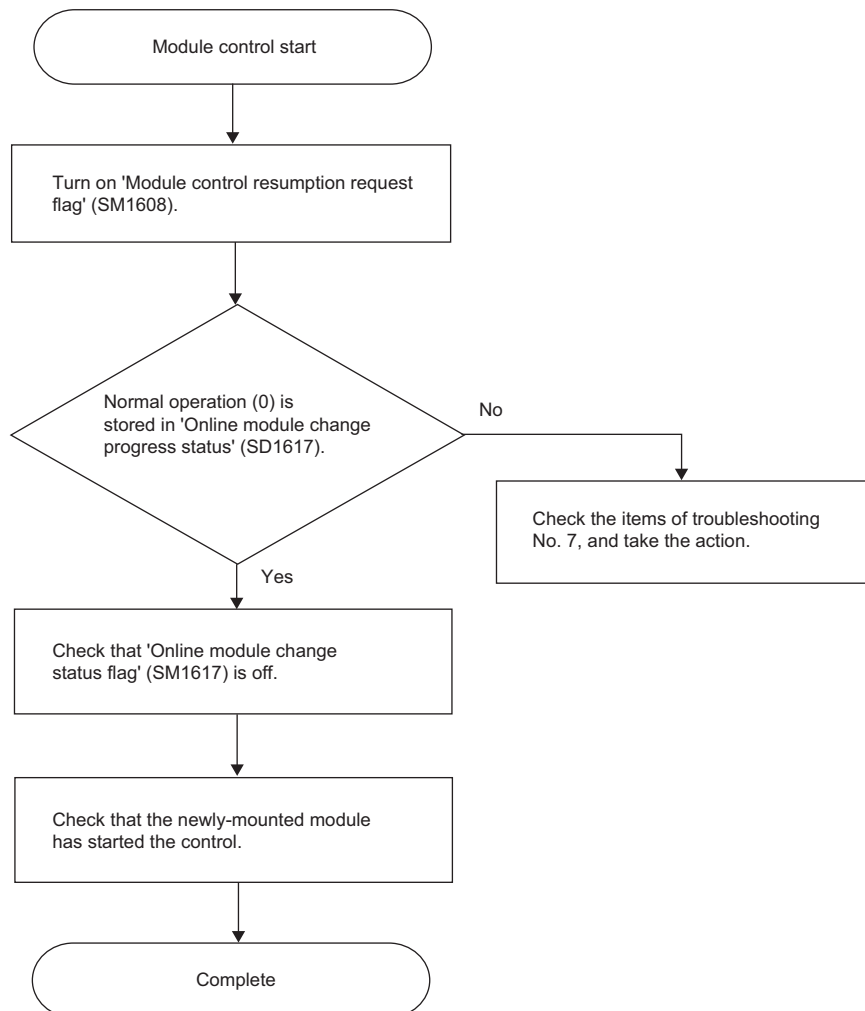

To check the control restart, check the following depending on the module.

■Redundant function modules

These modules have no items to check. The online module change has been completed.

■I/O modules

These modules have no items to check. The online module change has been completed.

■I/O modules with diagnostic functions

1. Check that 'Module READY' (X1F) is off.

'Module READY' (X1F) turns off when the READY LED on the CPU module (RUN LED on the remote head module) that is flashing (at 400ms intervals) turns on. To execute the initial setting using a program, design the program so that the initial setting is executed when 'Module READY' (X1F) turns off. Do not design a program that executes the initial setting only in one scan after the CPU module has started running. Otherwise, the initial setting is not executed.

2. The online module change has been completed.

For details on the I/O signals and buffer memory areas of the I/O modules with diagnostic functions, refer to the following.

📖 MELSEC iQ-R I/O Module (With Diagnostic Functions) User's Manual (Application)

■A/D converter modules (for the R60AD4), D/A converter modules (for the R60DA4), temperature input modules (for the R60TD8-G), temperature control modules (for the R60TCTRT2TT2)

1. Check that 'Module READY' (X0) is on.

'Module READY' (X0) turns on when the READY LED on the CPU module (RUN LED on the remote head module) that is flashing (at 400ms intervals) turns on. To execute the initial setting using a program, design the program so that the initial setting is executed when 'Module READY' (X0) turns on. Do not design a program that executes the initial setting only in one scan after the CPU module has started running. Otherwise, the initial setting is not executed.

2. The online module change has been completed.

For the online module change of other modules, also check as above. For details on the I/O signals and buffer memory areas of each module, refer to the User's Manual (Application) for the module used.

■Simple motion modules (for the RD77MS16)

1. Check that Synchronization flag [X1] is on.

Synchronization flag [X1] turns on when the READY LED on the CPU module (RUN LED on the remote head module) that is flashing (at 400ms intervals) turns on. At this time, execute the initial setting or home position return as necessary. To execute the initial setting or home position return using a program, design the program so that the initial setting or home position return is executed when Synchronization flag [X1] turns on. Do not design a program that executes the initial setting or home position return only in one scan after the CPU module has started running. Otherwise, the initial setting or home position return is not executed.

2. The online module change has been completed.

For the online module change of other simple motion modules, also check as above. For details on the I/O signals and buffer memory areas of each simple motion module, refer to the User's Manual (Application) for the simple motion module used.

■High-speed counter modules (for the RD62P2)

1. Check that 'Module READY' (X0) is on.

2. The online module change has been completed.

For the online module change of other high-speed counter modules, also check as above. For details on the I/O signals and buffer memory areas of each high-speed counter module, refer to the User's Manual (Application) for the high-speed counter module used.

■Flexible high-speed I/O control modules (for the RD40PD01)

1. Check that 'Module READY' (X0) is on.

2. The online module change has been completed.

3. The hardware logic control is stopped immediately after the online module change. To resume the hardware logic control, turn on 'Hardware logic control start request' (Y4). Or perform [Online] ⇒ [Module operation] ⇒ [Hardware logic control Start] from the configuration tool.

■Positioning modules (for the RD75P4)

1. Check that Module access flag [X1] is on.

Module access flag [X1] turns on when the READY LED on the CPU module (RUN LED on the remote head module) that is flashing (at 400ms intervals) turns on. At this time, execute the initial setting or home position return as necessary. To execute the initial setting or home position return using a program, design the program so that the initial setting or home position return is executed when Module access flag [X1] turns on. Do not design a program that executes the initial setting or home position return only in one scan after the CPU module has started running. Otherwise, the initial setting or home position return is not executed.

To prevent an external device from malfunctioning, design the program so that positioning control is started after the external device becomes ready for operation.

2. The online module change has been completed.

For the online module change of other positioning modules, also check as above. For details on the I/O signals and buffer memory areas of each positioning module, refer to the User's Manual (Application) for the positioning module used.

■MES interface module

1. Check that 'Module READY' (X0) is on.
2. Check that 'Information linkage status' (X1) is on.
3. The online module change has been completed.

■High speed data logger module

1. Check that 'Module READY' (X0) is on.
2. Check that 'SD memory card status' (X1) is on, 'File access status' (X2) is off, and 'Module operating status' (X5) is on.
3. The online module change has been completed.

■C intelligent function module

1. Check that 'Module READY' (X0) is on.
2. Check that 'SD memory card status' (X1) and 'User script execution status' (X3) are on.
3. The online module change has been completed.

■OPC UA server module

1. Check that 'Module READY' (X0) is on.
2. Check that 'OPC UA Server status' (X1) is on.
3. The online module change has been completed.

Cancel of module selection

Module selection for an online module change can be canceled before the online module change is started. When an incorrect module has been selected as the replacement target module, the selection can be canceled by turning on 'Module selection cancel request flag' (SM1615) before the module change is started.

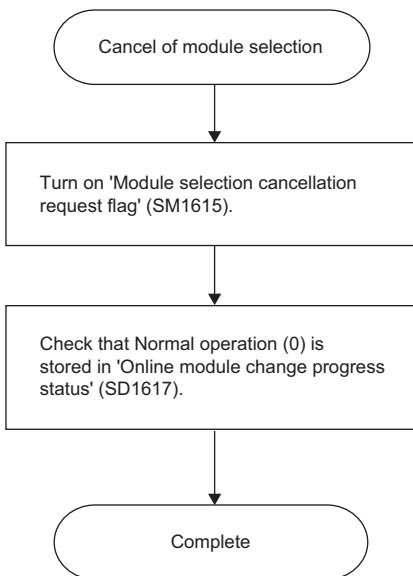

3.5 Changing a Module Directly

This section describes the method to change a module directly.

Restriction

The direct change is not available for redundant function modules as a method of the online module change.

Presettings

To perform a direct online module change, "Direct change setting" must be set to "Enable" in advance.

Navigation window ⇒ [Parameter] ⇒ Module model name ⇒ [CPU Parameter] ⇒ "RAS Setting" ⇒ "Online module change setting" ⇒ "Direct change setting"

■When "Direct change setting" is set to "Enable"

An error occurs when a module is removed in direct change. However, setting "Direct change setting" to "Enable" allows the replacement to continue without a stop even though "CPU Module Operation Setting at Error Detection" is set to "Stop". The following table shows the target parameter settings and errors.

Parameter setting item	Parameter setting	Error code	Error name
CPU Parameter ⇒ RAS Setting ⇒ CPU Module Operation Setting at Error Detected	Module Verify Error: "Stop"	2400H	Module verification error
		2401H	Module verification error
	Fuse Blown: "Stop"	2420H	Fuse blown error
System Parameter ⇒ I/O Assignment Setting (each module) ⇒ CPU Module Operation Setting at Error Detected	Moderate: Stop	1200H	Module moderate error
	Critical: Stop	2450H	Module major error
None	None	2440H	Module major error
None	None	2443H	Module major error

If any of the errors above remains and affects the system, set "Direct change setting" to "Disable" and perform an online module change using special relays and special registers.

In the multiple CPU system, when any of the CPU modules is set to "Enable" in "Direct change setting" (including the case where other CPU modules are set to "Disable" in "Direct change setting"), all the modules continue each operation without stopping even if any of the errors above occurs.

In a redundant system, the above errors, which cause system switching, remain. Thus, the systems are not switched. In addition, the above errors due to module mounting/removal during operation remain regardless of the parameter setting. Thus, the systems are not switched even if a module is removed or has a failure on the control system.

■Precautions for direct change

If direct change is predicted, always configure safety circuits external to the programmable controller to ensure that the entire system operates safely and perform the following.

- After ensuring the system safety by configuring safety circuits, perform direct change.
- To replace a module that gives outputs to external devices, configure an external interlock circuit on a program so that the outputs are turned off interlocking with safety circuits.
- Before performing direct change on a system that is already operating, make sure to confirm that direct change does not affect the system.

Before removing a module, always shut off the external power supply input to the module.

Checks before replacement

The following shows the check procedure before replacement. In this procedure, stop the control of the online module change target module for safe online module change.

The procedure is the same as that of the online module change using special relays and special registers. Refer to the following.

Page 30 Checks before replacement

Module removal

The following shows the procedure to remove the module. In this procedure, remove the target module from the base unit. This procedure is common among all the modules.

In direct change, when a module is removed, input values from the module to the CPU module or remote head module may become undefined. Check that the system does not malfunction before removing the module.

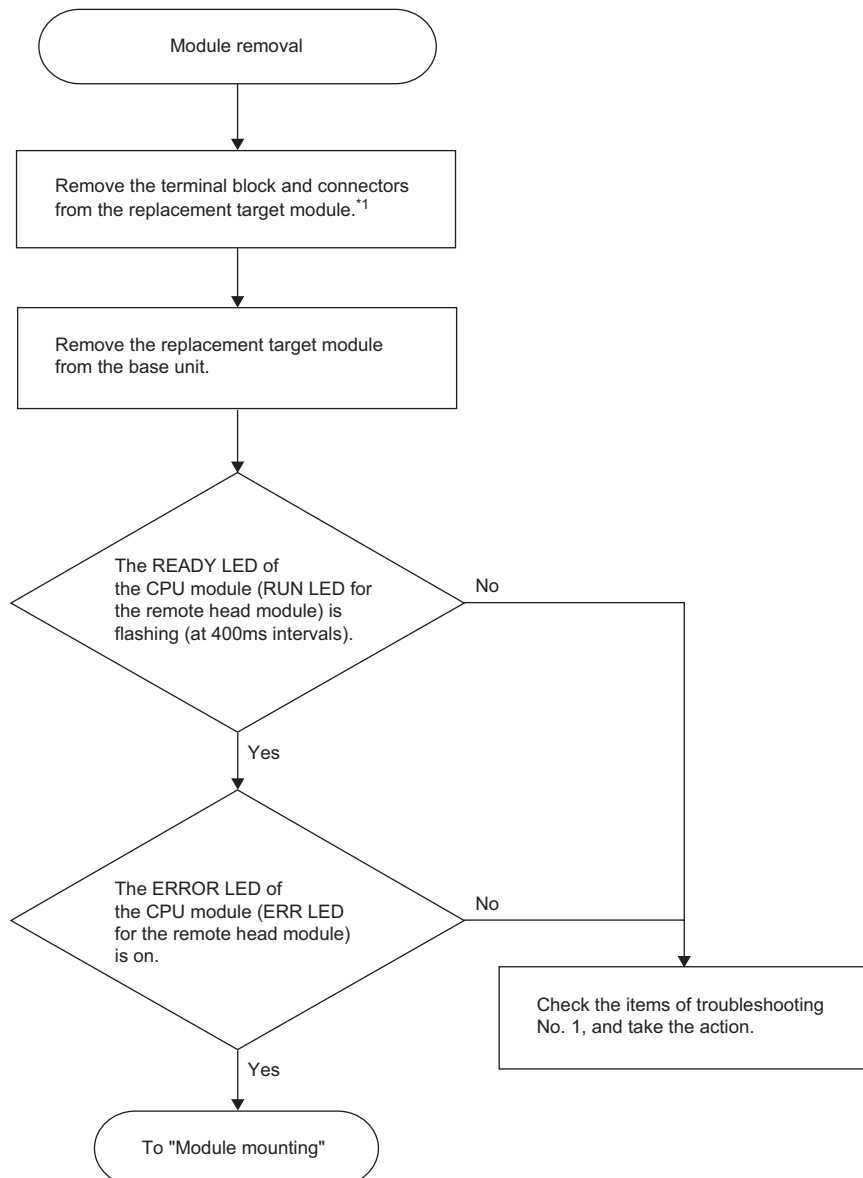

*1 Remove the SD memory card from the module to be replaced when MES interface module, high speed data logger module, C intelligent function module, and OPC UA server module are used.

Module mounting

The following shows the procedure to mount the module. In this procedure, mount the target module on the base unit. This procedure is common among all the modules.

In direct change, control is immediately started after the module is mounted. Thus, after mounting a terminal block and connectors to the module, check that the system does not malfunction and mount the module.

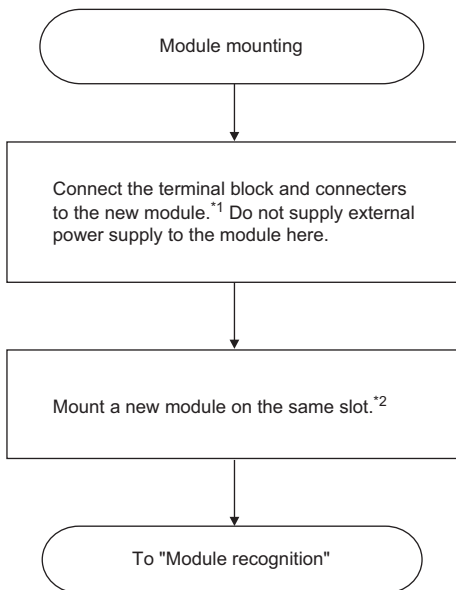

*1 Insert the SD memory card (which was removed when the module was removed) to a new module, if MES interface module, high speed data logger module, C intelligent function module, and OPC UA server module are used.

*2 If mounting a module fails, an error may occur at module recognition. Remove and mount the module again.

Module recognition

The following shows the procedure to recognize the module. The new module is automatically recognized by the system. In this procedure, check if the module has been normally recognized. This procedure is common among all the modules.

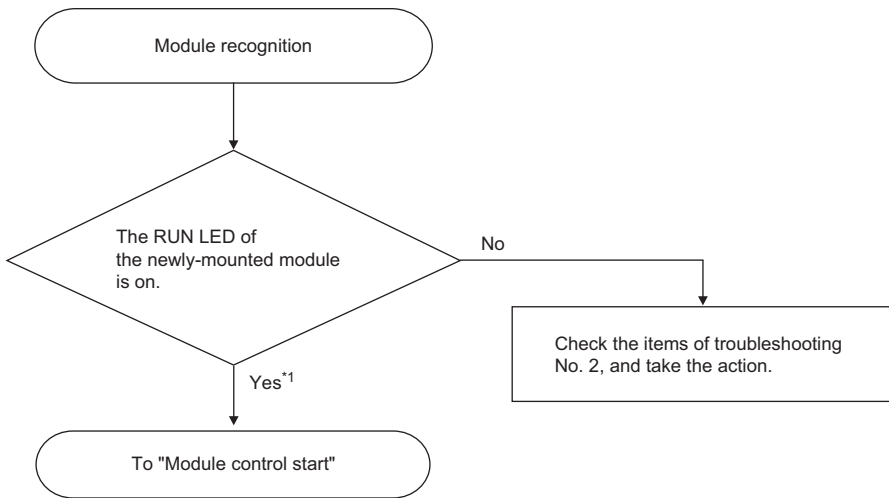

*1 When the initial setting is configured with the module parameter of an engineering tool, the setting of the module parameter is applied when the RUN LED turns on.

■MES interface module

Check that the SD memory card or Ethernet cable is correctly inserted when an error occurs due to incorrectly inserted SD memory card or Ethernet cable. Clear the error with any of the following operations.

- Turn on 'Error clear request' (Y10).
- Execute error clear in the diagnostics window of the MES Interface Function Configuration Tool.

■OPC UA server module

Check that the SD memory card or Ethernet cable is correctly inserted when an error occurs due to incorrectly inserted SD memory card or Ethernet cable. Clear the error with any of the following operations.

- Turn on 'Error clear request' (Y10).
- Update the setting from the MX OPC UA Module Configurator-R.

Module control start

The following shows the procedure to restart the module control. In this procedure, complete the online module change and restart the control of the new module. Before restarting the control of the module, check the following precautions.

■Precautions

- Make sure the new module is mounted completely and the module fixing hook is securely fixed.
- Make sure the connectors and terminal blocks connected to the module are free from looseness and rattles.
- Fix a module without the module fixing hook with module fixing screws securely though the RUN LED turns on under fixing the screws.

■Procedure

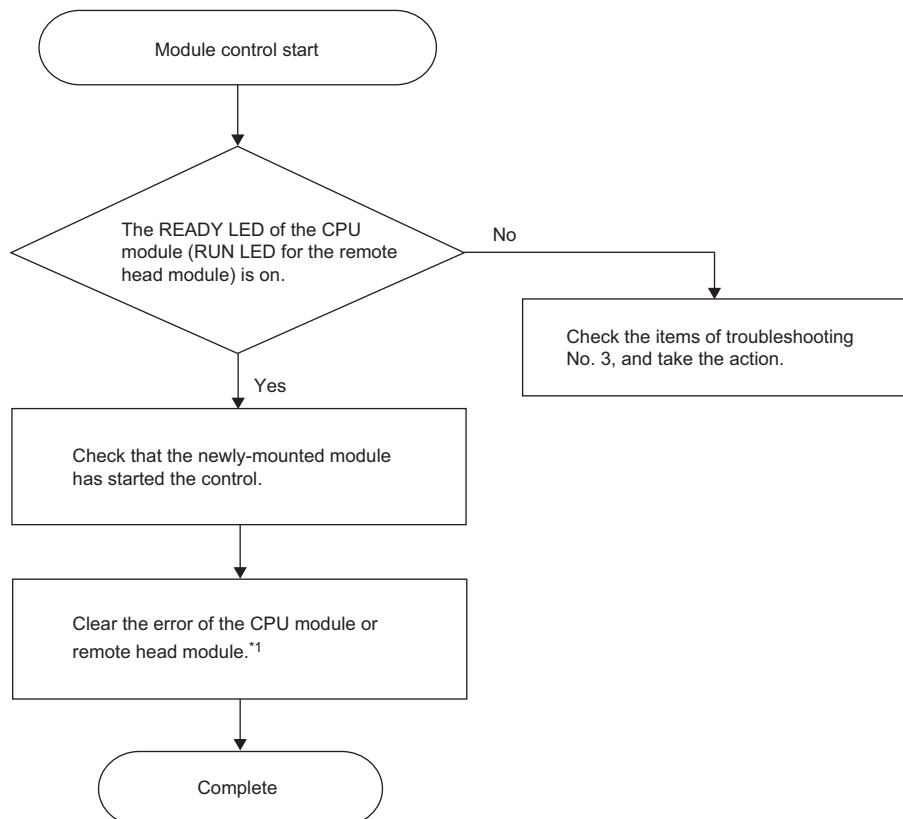

*1 To clear errors on the CPU module and remote head module, use either of the following methods.

- Using the engineering tool (📖 GX Works3 Operating Manual)
- Using SM/SD (📖 MELSEC iQ-R CPU Module User's Manual (Application), 📖 MELSEC iQ-R CC-Link IE Field Network Remote Head Module User's Manual (Application))

To check the control restart, check the following depending on the module.

■I/O modules

1. If the target module is an I/O module that requires external power supply, supply the external power supply to the module.
2. The online module change has been completed.

■I/O modules with diagnostic functions

1. Check that 'Module READY' (X1F) is off.

After module recognition, 'Module READY' (X1F) turns off. To execute the initial setting using a program, design the program so that the initial setting is executed when 'Module READY' (X1F) turns off. Do not design a program that executes the initial setting only in one scan after the CPU module has started running. Otherwise, the initial setting is not executed.

2. Supply external power supply to the module.
3. The online module change has been completed.

For details on the I/O signals and buffer memory areas of the I/O modules with diagnostic functions, refer to the following.

📖 MELSEC iQ-R I/O Module (With Diagnostic Functions) User's Manual (Application)

■A/D converter modules (for the R60AD4), D/A converter modules (for the R60DA4), temperature input modules (for the R60TD8-G), temperature control modules (for the R60TCTRT2TT2)

1. Check that 'Module READY' (X0) is on.

After module recognition, 'Module READY' (X0) turns on. To execute the initial setting using a program, design the program so that the initial setting is executed when 'Module READY' (X0) turns on. Do not design a program that executes the initial setting only in one scan after the CPU module has started running. Otherwise, the initial setting is not executed.

2. If the target module is a D/A converter module, supply external power supply to the module.

3. The online module change has been completed.

For the online module change of other modules, also check as above. For details on the I/O signals and buffer memory areas of each module, refer to the User's Manual (Application) for the module used.

■High-speed counter modules (for the RD62P2)

1. Check that 'Module READY' (X0) is on.

To execute the initial setting using a program, use the same program that is used for online module change using special relays and special registers to implement an interlock. For the program, refer to the following.

☞ Page 38 Initial setting for high-speed counter modules

Do not design a program that executes the initial setting only in one scan after the CPU module has started running. Otherwise, the initial setting is not executed.

For the online module change of other high-speed counter modules, also check as above. For details on the I/O signals and buffer memory areas of each high-speed counter module, refer to the User's Manual (Application) for the high-speed counter module used.

■Flexible high-speed I/O control modules (for the RD40PD01)

1. Check that 'Module READY' (X0) is on.

2. The online module change has been completed.

3. The hardware logic control is stopped immediately after the online module change. To resume the hardware logic control, turn on 'Hardware logic control start request' (Y4). Or perform [Online] ⇒ [Module operation] ⇒ [Hardware logic control Start] from the configuration tool.

■Simple motion modules (for the RD77MS16)

1. Check that Synchronization flag [X1] is on.

Synchronization flag [X1] turns on after module recognition. At this time, execute the initial setting or home position return as necessary. To execute the initial setting or home position return using a program, design the program so that the initial setting or home position return is executed when Synchronization flag [X1] turns on. Do not design a program that executes the initial setting or home position return only in one scan after the CPU module has started running. Otherwise, the initial setting or home position return is not executed.

2. The online module change has been completed.

For the online module change of other simple motion modules, also check as above. For details on the I/O signals and buffer memory areas of each simple motion module, refer to the User's Manual (Application) for the simple motion module used.

■Positioning modules (for the RD75P4)

1. Check that Module access flag [X1] is on.

After module recognition, Module access flag [X1] turns on. At this time, execute the initial setting or home position return as necessary. To execute the initial setting or home position return using a program, design the program so that the initial setting or home position return is executed when Module access flag [X1] turns on. Do not design a program that executes the initial setting or home position return only in one scan after the CPU module has started running. Otherwise, the initial setting or home position return is not executed.

To prevent an external device from malfunctioning, design the program so that positioning control is started after the external device becomes ready for operation.

2. The online module change has been completed.

For the online module change of other positioning modules, also check as above. For details on the I/O signals and buffer memory areas of each positioning module, refer to the User's Manual (Application) for the positioning module used.

■MES interface module

1. Check that 'Module READY' (X0) is on.
2. Check that 'Information linkage status' (X1) is on.
3. The online module change has been completed.

■High speed data logger module

1. Check that 'Module READY' (X0) is on.
2. Check that 'SD memory card status' (X1) is on, 'File access status' (X2) is off, and 'Module operating status' (X5) is on.
3. The online module change has been completed.

■C intelligent function module

1. Check that 'Module READY' (X0) is on.
2. Check that 'SD memory card status' (X1) and 'User script execution status' (X3) are on.
3. The online module change has been completed.

■OPC UA server module

1. Check that 'Module READY' (X0) is on.
2. Check that 'OPC UA Server Status' (X1) is on.
3. The online module change has been completed.

4 TROUBLESHOOTING

This chapter describes the troubleshooting related to online module change.

4.1 Error Processing and Recovery Methods

This section describes how errors are processed and informed, and how to recover from the errors if there is an abnormality in online module change. For the errors relating to online module change, perform a check according to the type of error in the description below.

Errors relating to online module change

For the errors relating to online module change, perform a check with 'Online module change error flag' (SM1618) and 'Online module change error code' (SD1618).

If an error relating to online module change has occurred, 'Online module change error flag' (SM1618) turns on. The LED status does not change at this time. To check the detection of an error of online module change with the LED status, use an annunciator.*1 For the cause of the error, check the value stored in 'Online module change error code' (SD1618). For details on the error codes to be stored, refer to the following.

 MELSEC iQ-R CPU Module User's Manual (Application)

*1 Remote head modules have no annunciators.

Errors relating to an operation from the outside

For the errors relating to an operation from the outside during online module change, perform a check with 'Online module changing disable request flag' (SM1619) and 'Online module changing disable request error code' (SD1619).

If an error relating to an operation from the outside during online module change has occurred, 'Online module changing disable request flag' (SM1619) turns on. For the cause of the error, check the value stored in 'Online module changing disable request error code' (SD1619). For details on the error codes to be stored, refer to the following.

 MELSEC iQ-R CPU Module User's Manual (Application)

4.2 Troubleshooting by Symptom

This section describes the troubleshooting by symptom.

For the replacement by means of control of special relays and special registers

The troubleshooting when a module is replaced controlling special relays and special registers is shown in the following table for each step in online module change.

No.	Procedure	Symptom	Check item	Action
1	Module selection	After 'Module selection request flag' (SM1600) is turned on, 'Online module changing status' (SD1617) does not become Module selection completion (2).	Is 'Online module change error flag' (SM1618) on?	<p>When 'Online module change error flag' (SM1618) is on, it indicates that an incorrect module has been specified due to any of the following causes:</p> <ul style="list-style-type: none"> ❶ A module that does not support the online module change function has been specified. ❷ An I/O number with which no module is mounted has been specified using 'Module selection (base No.)' (SD1600) and 'Module selection (slot No.)' (SD1601). ❸ A module under control of another CPU module has been specified. <p>Take the following corrective actions against each cause:</p> <ul style="list-style-type: none"> ❶ To replace a module that does not support the online module change function, power off the programmable controller before the replacement. ❷ Correct the specified base unit number and slot number, set 'Online module change error code' (SD1618) to 0, and turn off 'Online module change error flag' (SM1618) and 'Module selection request flag' (SM1600). After that, try again from the step of module selection. ❸ Perform online module change from the CPU module or remote head module that controls the module. <p>When 'Online module change error flag' (SM1618) is off, the CPU module or remote head module may be in failure. Replace the CPU module or remote head module.</p>
2	Module selection	After 'Module selection request flag' (SM1600) is turned on, 'Online module changing status' (SD1617) becomes Module selection completion (2), but the value in 'Online module changing module I/O No.' (SD1602) does not match the start I/O number assigned to the module to be replaced.	—	<p>If an incorrect module is selected as the replacement target module, turn on 'Module selection cancel request flag' (SM1615), and then try again from the step of module selection to select a correct module. (☞ Page 33 Module selection)</p>
3	Module change activation	After 'Module remove request flag' (SM1602) is turned on, 'Online module changing status' (SD1617) does not become Module removal ready (4).	Is 'Online module change error flag' (SM1618) on?	<p>When 'Online module change error flag' (SM1618) is on, take the corrective actions corresponding to the error code stored in 'Online module change error code' (SD1618). (☞ MELSEC iQ-R CPU Module User's Manual (Application))</p> <p>When 'Online module change error flag' (SM1618) is off, the CPU module or remote head module may be in failure. Replace the CPU module or remote head module.</p>
4	Module removal	After the module is removed, 'Online module changing status' (SD1617) does not become Module removal completion (5).	Is the removed module the one specified in the step of module selection?	<p>When the removed module is not the one specified, power off and on the programmable controller to recover the system.</p>
5	Module mounting	After a new module is mounted, 'Online module changing status' (SD1617) does not become Module mounting completion (6).	Is 'Online module change error flag' (SM1618) on?	<p>When 'Online module change error flag' (SM1618) is on, take the corrective actions corresponding to the error code stored in 'Online module change error code' (SD1618). (☞ MELSEC iQ-R CPU Module User's Manual (Application))</p> <p>When 'Online module change error flag' (SM1618) is off, the CPU module or remote head module may be in failure. Replace the CPU module or remote head module.</p>

No.	Procedure	Symptom	Check item	Action
6	Module recognition	After 'Module recognition request flag' (SM1606) is turned on, 'Online module changing status' (SD1617) does not become Module recognition completion (8).	Is 'Online module change error flag' (SM1618) on?	<p>When 'Online module change error flag' (SM1618) is on, take the corrective actions corresponding to the error code stored in 'Online module change error code' (SD1618). (MELSEC iQ-R CPU Module User's Manual (Application))</p> <p>After that, try again from the step of module recognition. (Page 37 Module recognition)</p> <p>When 'Online module change error flag' (SM1618) is off, the CPU module or remote head module may be in failure. Replace the CPU module or remote head module.</p>
7	Module control start	After 'Module control resumption request flag' (SM1608) is turned on, 'Online module changing status' (SD1617) does not become Normal operation (0).	Is 'Online module change error flag' (SM1618) on?	<p>When 'Online module change error flag' (SM1618) is on, take the corrective actions corresponding to the error code stored in 'Online module change error code' (SD1618). (MELSEC iQ-R CPU Module User's Manual (Application))</p> <p>When 'Online module change error flag' (SM1618) is off, the CPU module or remote head module may be in failure. Replace the CPU module or remote head module.</p>

For the direct change

The troubleshooting when a module is changed directly is shown in the following table for each step in online module change.

No.	Procedure	Symptom	Check item	Action
1	Module removal	After the module is removed, the READY LED on the CPU module (RUN LED on the remote head module) does not flash (interval of 400ms).	Is 'Online module change error flag' (SM1618) on?	<p>When 'Online module change error flag' (SM1618) is on, take the corrective actions corresponding to the error code stored in 'Online module change error code' (SD1618). (MELSEC iQ-R CPU Module User's Manual (Application))</p> <p>After that, try online module change from the start again.</p>
2	Module recognition	After a new module is mounted, the RUN LED on the module does not turn on.	Is 'Online module change error flag' (SM1618) on?	<p>When 'Online module change error flag' (SM1618) is on, take the corrective actions corresponding to the error code stored in 'Online module change error code' (SD1618). (MELSEC iQ-R CPU Module User's Manual (Application))</p> <p>As an alternative corrective action, remove and mount the module again.</p>
3	Module control start	The READY LED on the CPU module (RUN LED on the remote head module) does not turn on.	Is 'Online module change error flag' (SM1618) on?	<p>When 'Online module change error flag' (SM1618) is on, take the corrective actions corresponding to the error code stored in 'Online module change error code' (SD1618). (MELSEC iQ-R CPU Module User's Manual (Application))</p> <p>As an alternative corrective action, remove and mount the module again.</p>

INDEX

A

A/D converter module 5

B

Backup mode 5

C

C intelligent function module 5
Changing a module by controlling special relays and
special registers 29
Changing a module directly 7,43
Changing a module using special relays and
special registers 6
Control CPU 5
Control system 5
CPU module 5

D

D/A converter module 5
Dedicated instruction 5

E

Engineering tool 5

H

High speed data logger module 5
High-speed counter module 5

I

I/O module 5
Intelligent function module 5

M

MES interface module 5
Multiple CPU system 5

O

Online module change 6
OPC UA server module 5

P

Positioning module 5
Process CPU 5

R

Redundant function module 5
Redundant system 5
Remote head module 5

S

Separate mode 5
Simple motion module 5
Single CPU system 5
Standby system 5

T

Temperature control module 5
Temperature input module 5

MEMO

REVISIONS

*The manual number is given on the bottom left of the back cover.

Revision date	*Manual number	Description
January 2015	SH(NA)-081501ENG-A	First edition
April 2015	SH(NA)-081501ENG-B	■Added models RX40PC6H, RX40NC6H
July 2015	SH(NA)-081501ENG-C	■Added models R60TCRT2TT2, R60TCRT4, R60TCRT2TT2BW, R60TCRT4BW
January 2016	SH(NA)-081501ENG-D	■Added models RY41NT2H, RY41PT2H, R60ADH4, RD81MES96, RD81DL96, RD55UP06-V
May 2016	SH(NA)-081501ENG-E	■Added models R6RFM, RX41C6HS, RX61C6HS, RX40NC6B, RY40PT5B, RJ72GF15-T2
October 2016	SH(NA)-081501ENG-F	■Added models RY20S6, RD40PD01
February 2017	SH(NA)-081501ENG-G	■Added models RX28, RY18R2A, R60DAH4
April 2017	SH(NA)-081501ENG-H	■Added models RD81OPC96

Japanese manual number: SH-081500-H

This manual confers no industrial property rights of any other kind, nor does it confer any patent licenses. Mitsubishi Electric Corporation cannot be held responsible for any problems involving industrial property rights which may occur as a result of using the contents noted in this manual.

© 2015 MITSUBISHI ELECTRIC CORPORATION

WARRANTY

Please confirm the following product warranty details before using this product.

1. Gratis Warranty Term and Gratis Warranty Range

If any faults or defects (hereinafter "Failure") found to be the responsibility of Mitsubishi occurs during use of the product within the gratis warranty term, the product shall be repaired at no cost via the sales representative or Mitsubishi Service Company.

However, if repairs are required onsite at domestic or overseas location, expenses to send an engineer will be solely at the customer's discretion. Mitsubishi shall not be held responsible for any re-commissioning, maintenance, or testing on-site that involves replacement of the failed module.

[Gratis Warranty Term]

The gratis warranty term of the product shall be for one year after the date of purchase or delivery to a designated place. Note that after manufacture and shipment from Mitsubishi, the maximum distribution period shall be six (6) months, and the longest gratis warranty term after manufacturing shall be eighteen (18) months. The gratis warranty term of repair parts shall not exceed the gratis warranty term before repairs.

[Gratis Warranty Range]

- (1) The range shall be limited to normal use within the usage state, usage methods and usage environment, etc., which follow the conditions and precautions, etc., given in the instruction manual, user's manual and caution labels on the product.
- (2) Even within the gratis warranty term, repairs shall be charged for in the following cases.
 1. Failure occurring from inappropriate storage or handling, carelessness or negligence by the user. Failure caused by the user's hardware or software design.
 2. Failure caused by unapproved modifications, etc., to the product by the user.
 3. When the Mitsubishi product is assembled into a user's device, Failure that could have been avoided if functions or structures, judged as necessary in the legal safety measures the user's device is subject to or as necessary by industry standards, had been provided.
 4. Failure that could have been avoided if consumable parts (battery, backlight, fuse, etc.) designated in the instruction manual had been correctly serviced or replaced.
 5. Failure caused by external irresistible forces such as fires or abnormal voltages, and Failure caused by force majeure such as earthquakes, lightning, wind and water damage.
 6. Failure caused by reasons unpredictable by scientific technology standards at time of shipment from Mitsubishi.
 7. Any other failure found not to be the responsibility of Mitsubishi or that admitted not to be so by the user.

2. Onerous repair term after discontinuation of production

- (1) Mitsubishi shall accept onerous product repairs for seven (7) years after production of the product is discontinued. Discontinuation of production shall be notified with Mitsubishi Technical Bulletins, etc.
- (2) Product supply (including repair parts) is not available after production is discontinued.

3. Overseas service

Overseas, repairs shall be accepted by Mitsubishi's local overseas FA Center. Note that the repair conditions at each FA Center may differ.

4. Exclusion of loss in opportunity and secondary loss from warranty liability

Regardless of the gratis warranty term, Mitsubishi shall not be liable for compensation to:

- (1) Damages caused by any cause found not to be the responsibility of Mitsubishi.
- (2) Loss in opportunity, lost profits incurred to the user by Failures of Mitsubishi products.
- (3) Special damages and secondary damages whether foreseeable or not, compensation for accidents, and compensation for damages to products other than Mitsubishi products.
- (4) Replacement by the user, maintenance of on-site equipment, start-up test run and other tasks.

5. Changes in product specifications

The specifications given in the catalogs, manuals or technical documents are subject to change without prior notice.

TRADEMARKS

Ethernet is a registered trademark of Fuji Xerox Co., Ltd. in Japan.

The company names, system names and product names mentioned in this manual are either registered trademarks or trademarks of their respective companies.

In some cases, trademark symbols such as [™] or [®] are not specified in this manual.

SH(NA)-081501ENG-H(1704)MEE

MODEL: R-OMC-E

MODEL CODE: 13JX35

MITSUBISHI ELECTRIC CORPORATION

HEAD OFFICE : TOKYO BUILDING, 2-7-3 MARUNOUCHI, CHIYODA-KU, TOKYO 100-8310, JAPAN
NAGOYA WORKS : 1-14, YADA-MINAMI 5-CHOME, HIGASHI-KU, NAGOYA, JAPAN

When exported from Japan, this manual does not require application to the
Ministry of Economy, Trade and Industry for service transaction permission.

Specifications subject to change without notice.