

ASCO™ Mini-Solenoid Valves

intrinsically safe, II 1 G Ex ia IIC T6 to T4 Ga, II 1 D Ex ia IIIC T85°C to T135°C Da

ISO 15218 (CNOMO, size 15) interface, direct operated, pad mounting body, connector size 15

3/2
Series
302

Features and Benefits

- Mini-low consumption valves (0.25 W/0.5 W) for use in potentially explosive atmospheres according to ATEX-Directive 2014/34/EU
EC type examination certificate no.: **INERIS 03 ATEX 0249X**
IECEX Certificate of Conformity no.: **IECEX INE 10.0002X**
- Compliance with the Essential Health and Safety Requirements has been assured by compliance with the International and European Standards IEC and EN: 60079-0, 60079-11 and 60079-26
- The valve's Ex ia protection allows it to be installed in explosive atmospheres up to zone 0 or 20. It can be used in the chemical, oil and pharmaceutical industries, or in processing and packaging plants for flammable products (paints, solvents)
- Compact, monobloc pilot valve with spade plug. Connection according to DIN 43650, form C, 9.4 mm pin spacing
- Version with integrated display and electrical protection. LED visible from 3 sides

General

Differential pressure	0 - 8 bar [1 bar = 100 kPa]
Pneumatic base	ISO 15218 (CNOMO E06.36.120N, size 15)
Connection	Subbase
Response time	20 ms

Fluids (*)	Temperature range (TS)	Seal materials (*)
air or inert gas filtered (50 µm), without condensate, dew point: -20°C	0°C to +40°C (0.25 W)	NBR (nitrile) FPM (fluoroelastomer)
	-10°C to +40°C (0.5 W)	

Materials of components in contact with fluid

(*) Ensure that compatibility of materials in contact with fluids is verified.

Body	PARA
Internal parts	POM, PET, stainless steel and brass
Seals	NBR, FPM
Pneumatic interface seal	TPE

Other components

Coil	Thermoplastic PET
-------------	-------------------

Electrical characteristics

Coil insulation class	F  II 1 G Ex ia IIC T6 to T4 Ga II 1 D Ex ia IIIC T85°C to T135°C Da
------------------------------	--

Connector	Spade plug (cable Ø 4-6 mm)
Connector specification	DIN 43650, 9.4 mm, form C
Electrical safety	IEC 335
Electrical enclosure protection	Moulded IP65 (EN 60529)
Standard voltages	DC (=) : 12V - 24V ⁽²⁾ (0.25 W = 24 V only)

voltage (U _n) (max. ripple 10%)	power ratings (P _n) ^(*) hot/cold =	typical functional ratings					ambient temperature range (TS)	type ⁽¹⁾
		I _(ON) min. with LED	U _(ON) min.	U _(MAX) recommended	U _(OFF) turn off	I _(OFF) turn off		
(V)	(W)	(mA)	(V)	(V)	(V)	(mA)	(°C) ⁽¹⁾	01
LP1 "24V"	0.25	20	12.2	28	3.3	7	0 to +40/50/60	
LP1 "12V"	0.5	33	11.9	23	3.3	10	-10 to +40/50/60	
LP1 "24V"		25	16.4	28	5.7	7		

^(*) Nominal power ratings of standard versions (with LED indicator and electrical protection)

P _n	safety parameters				
	U _i = (DC)	I _i	P _i	L _i	C _i
(W)	(V)	(mA)	(W)	(mH)	(µF)
0.25/0.5	28	300	1.6	0	0

Temperature classification table DC (=)

P _i (watt)	maximum ambient °C ⁽²⁾					
	surface temperature					
	T6 85°C		T5 100°C		T4 135°C	
	12V	24V	12V	24V	12V	24V
1.6	38	33	50	48	60	60
	-	-	44	40	60	60

Insulation class F (155°C) 100% E.D. ⁽³⁾

Example of use with a Zener barrier installed in a non-hazardous zone:
safe area (RS interface) cable explosive area

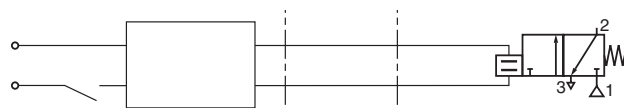

⁽¹⁾ Refer to the dimensional drawings.

⁽²⁾ **Minimum ambient temperature:**
0°C (0.25 W) / -10°C (0.5 W)

⁽³⁾ Coil designed for permanent duty within maximum ambient temperature limits. The solenoid valve must be connected to a special certified electrical supply unit installed in a non-dangerous zone. List of safety barrier manufacturers on the following page.

NC 

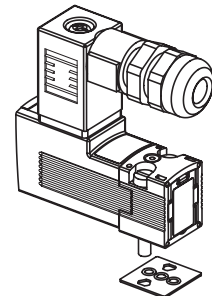

PNEUMATIC CNOMO interface

Specifications

orifice size (mm)	flow				operating pressure differential (bar)		power coil (W)	basic catalogue number
	at 6.3 bar l/min (ANR)		coefficient Kv		min.	max. (PS)		with impulse /maintained manual operator
	1 → 2	2 → 3	1 → 2	2 → 3				=
						(=)	(=)	
3/2 NC - normally closed (With LED and protection)								
0.6	4	11	0.04	0.16	0	8	0.25	30215311AD
	11	20	0.21	0.44	0	8	0.5	30215106AD

When ordering, please specify in addition to the basic catalogue number:

- voltage:

0.25 W: 24 V DC

0.5 W: 12 V DC or 24 V DC

Examples: with connector DIN 43650, 9.4 mm: **30215311AD** 24V DC
 with connector DIN 43650, 9.4 mm: **30215106AD** 12V DC
 with connector DIN 43650, 9.4 mm: **30215106AD** 24V DC

Options

- Solenoid valves without LED and electrical protection (0.5 W only)

Installation

- The solenoid valves can be mounted in any position without affecting operation
- Solenoid valve supplied with mounting screws and mounting pad seal(s)
- Electrical connection between solenoid valve and barrier/interface with cable type A or B according to EN 50039
- Installation on single subbase (3 x M5), brass body, catalogue number **30300001**
- Versions with spade-plug connector type ISO 15217/DIN 43650 form C with 8 mm spacing or M12 connection: contact us
- Installation/maintenance instructions are included with each valve

See the list for compatible interfaces and barriers.

This list is for reference only and the user must take into account the cables and the actual supply voltages for the barriers.

The operating conditions are calculated as follows:

0.25 W: 24 V with LED

$$I_1 \text{ (mA)} = \frac{[V_s - 1.2 - 0.002(R_b + R_1)] \times 1000}{(R_c + R_1 + R_b)} + 2$$

0.5 W: 12 V or 24 V with LED

$$I_1 \text{ (mA)} = \frac{[V_s - 1.2 - 0.003(R_b + R_1)] \times 1000}{(R_c + R_1 + R_b)} + 3$$

This value and the maximum barrier/interface current (if it is non-linear) must be greater than 33 mA (12 V with LED), 25 mA (24 V with LED, 0.5 W), 20 mA (24 V with LED, 0.25 W).

I_1 (mA) Min. supply current of the product

R_b (Ω) Max. barrier resistance

T_a (°C) Max. ambient temperature

R_1 (Ω) Max. resistance of connecting cables

V_s (V) Min. no-load voltage of barrier/interface

R_c (Ω) Max. coil resistance:

$$12 \text{ V with LED} = \frac{288(T_a + 234 + 10)}{254} \quad / \quad 24 \text{ V with LED} = \frac{563(T_a + 234 + 10)}{254}$$

Compatibles barriers

The 12 V DC and 24 V DC solenoid valves are compatible with the barriers listed in the tables.

Located in safe areas, these barriers allow to feed the intrinsically safe solenoid valves located in explosive areas.

0.5 W ASCO pilot 302				
Suppliers	Barrier reference	12 V with LED	24 V with LED	
ABB	DO910S/B/N	X	X	
	NAEV30-DO2C-A230-0	X	X	
	NAEV30-DO2C-A115-0	X	X	
AP3	NAEV30-DO2H-C024-0	X		
	NAEV30-DO4H-C024-0	X		
	NAEV30-DI2N-DO1C-A230-0	X	X	
	NAEV30-DI2N-DO1C-A115-0	X	X	
	NAEV30-DI2N-DO1H-C024-0	X	X	
	07-7331-2105/1000	X		
Bartec	07-7331-2301/1100	X		
	D5048S	X	X	
G.M. international	D5049S	X	X	
	D1045Y	X		
	D1048S	X	X	
	D1049S	X	X	
	D1040Q 2	X		
	D1040Q 3	X	X	
	D1041Q 3	X	X	
	D1041Q 4	X	X	
	D1042Q 2	X	X	
	D1042Q 3	X	X	
	D1043Q 2	X		
	D1043Q 3	X	X	
	D1043Q 4	X	X	
	MTL	MTL4521	X	X
		MTL5521	X	X
MTL4521L		X	X	
MTL5522		X	X	
MTL4523		X	X	
MTL5523		X	X	
MTL4523L		X	X	
MTL4523R		X	X	
MTL4523V		X	X	
MTL5523V		X	X	
MTL4524		X	X	
MTL5524		X	X	
MTL4524S		X	X	
MTL4525		X		
MTL5525		X		
MTL5521T		X	X	
MTL4523VL		X	X	
MTL5523VL		X	X	
MTL5523	X	X		

Not compatible

For other compatible barriers and interfaces, please ask our product support.

00163CB-2021/R01
Availability, design and specifications are subject to change without notice. All rights reserved.

In accordance with the zone classification and the national legislation of each country, apply the certification procedures for the connection of IS-rated products with associated equipment.

All information subject to change without notice. All responsibility for the use of products from other suppliers and the possible modifications of their characteristics is disclaimed.

Compatibles barriers

0.5 W ASCO pilot 302				
Suppliers	Barrier reference	12 V with LED	24 V with LED	
Pepperl + Fuchs	KCD0-SD3-Ex1.1045	X	X	
	KCD0-SD3-Ex1.1245	X	X	
	KCD0-SD-EX1.1245	X	X	
	KCD2-SLD-EX1.1045	X	X	
	KCD2-SLD-EX1.1065	X		
	KCD2-SLD-EX1.1245	X	X	
	KFD0-SD2-EX1.10100	X		
	KFD0-SD2-EX1.1045	X		
	KFD0-SD2-EX1.1065	X		
	KFD0-SD2-EX1.1180	X	X	
	KFD0-SD2-EX2.1045	X		
	KFD0-SD2-EX2.1245	X	X	
	KFD2-SL2-EX1	X	X	
	KFD2-SL2-EX1.B	X	X	
	KFD2-SL2-EX1.LK	X	X	
	KFD2-SL2-EX1.LK.1045	X		
	KFD2-SL2-EX2	X	X	
	KFD2-SL2-EX2.B	X	X	
	KCD0-SD3-Ex1.1245.SP	X	X	
	KCD0-SD-Ex1.1245.SP	X	X	
	KFD2-SL2-Ex1.LK-Y1	X	X	
	HIC2871	X	X	
	HIC2871A	X	X	
	HIC2873	X	X	
	HIC2877	X		
	HIC2883	X	X	
	HID2872	X	X	
	HID2876	X		
	LB-2103 AR/ER	X		
	LB-2112 AR/ER	X	X	
	FB-2203	X		
	FB-2212	X	X	
	FB-2216	X	X	
	FB2217	X		
	FB6216	X	X	
	FB6217	X		
	Stahl	9475/32-04-72	X	
		9176/ 10- 16- 00s	X	X
9176/ 20- 15- 00s 1 canal			X	
9176/ 20- 16- 00s 1 canal		X	X	
9176/ 20- 15- 00s 2 canaux		X	X	
9176/ 20- 16- 00s 2 canaux		X	X	
9176/ 20- 17- 00s 2 canaux		X	X	
9175/ 10- 14- 11s		X		
9175/ 10- 16- 11s		X	X	
9175/ 20- 14- 11s 1 canal		X		
9175/ 20- 16- 11s 1 canal		X	X	
9175/ 20- 14- 11s 2 canaux		X		
9175/ 20- 16- 11s 2 canaux		X	X	
9276/ 10- 21- 40- 00k		X		
9276/ 10- 21- 40- 00s		X		
9276/ 10- 21- 60- 00k		X	X	
9276/ 10- 21- 60- 00s		X	X	
9276/ 10- 24- 48- 00k		X	X	
9276/ 10- 24- 48- 00s		X	X	
9275/ 10- 24- 48- 11s		X	X	
Turck	IMX12-DO01-1U-1U-PR/ 24VDC/CC	X	X	
	MX12-DO01-1U-1U-0/24VDC/CC	X	X	
	IMX12-DO01-2U-2U-0/ 24VDC	X	X	
	IMX12-DO01-2U-2U-0/ 24VDC/CC	X	X	
	IMX12-DO01-2U-2U-PR/ 24VDC	X	X	
	IMX12-DO01-1U-1U-0/ 24VDC	X	X	
	IMC-DO-11EX/L	X	X	
	IMX12-DO01-2U-2U-PR/ 24VDC/CC	X	X	

 Not compatible For other compatible barriers and interfaces, please ask our product support.

In accordance with the zone classification and the national legislation of each country, apply the certification procedures for the connection of IS-rated products with associated equipment.
All information subject to change without notice. All responsibility for the use of products from other suppliers and the possible modifications of their characteristics is disclaimed.

00163GB-2021/ R01
Availability, design and specifications are subject to change without notice. All rights reserved.

Compatibles barriers

0.5 W ASCO pilot 302			
Suppliers	Barrier reference	12 V with LED	24 V with LED
Siemens	6ES71327GD100AB0 2 ways	X	
	6ES71327GD210AB0 2 ways	X	
	6ES71327RD220AB0 2 ways	X	
Phéonix contact	MACX MCR-EX-SL-SD-21-60-LP-SP - 2924100	X	X
	MACX MCR-EX-SL-SD-21-60-LP - 2865515	X	X
	MACX MCR-EX-SL-SD-24-48-LP - 2865609	X	X
	MACX MCR-EX-SL-SD-21-40-LP-SP - 2924139	X	
	MACX MCR-EX-SL-SD-21-40-LP - 2865764	X	
	MACX MCR-EX-SL-SD-24-48-LP-SP - 2924126	X	
	MACX MCR-EX-SL-SD-24-48-LFD-SP - 2906156	X	X
	MACX MCR-EX-SL-SD-24-48-LFD - 2906155	X	X
	MACX MCR-EX-SL-SD-23-48-LFD-SP - 2924870	X	
	MACX MCR-EX-SL-SD-23-48-LFD - 2924867	X	
	PI-EX-SD-24-48 - 2865298	X	X
PI-EX-SD-21-60 - 2865188	X	X	
WAGO	750-535	X	X
	750-535/040-000	X	X
	750-539	X	X

Not compatible

For other compatible barriers and interfaces, please ask our product support.

0.25 W ASCO pilot 302		
Suppliers	Barrier reference	24 V with LED
ABB	DO910S/B/N	X
BARTEC	07-7331-2105/1000	X
	07-7331-2301/1100	X
G.M international	D5048S	X
	D1045Y	X
	D1048S	X
	D1049S	X
	D1040Q 1	X
	D1040Q 2	X
	D1040Q 3	X
	D1041Q 2	X
	D1041Q 3	X
	D1041Q 4	X
	D1042Q 1	X
	D1042Q 2	X
	D1042Q 3	X
	D1043Q 2	X
	D1043Q 3	X
	D1043Q 4	X
MTL	MTL4521	X
	MTL5521	X
	MTL4521L	X
	MTL5522	X
	MTL4523	X
	MTL5523	X
	MTL4523L	X
	MTL4523R	X
	MTL4523V	X
	MTL5523V	X
	MTL4524	X
	MTL5524	X
	MTL4524S	X
	MTL4525	X
	MTL5525	X
MTL5521T	X	
MTL4523VL	X	
MTL5523VL	X	
MTL5523	X	

In accordance with the zone classification and the national legislation of each country, apply the certification procedures for the connection of IS-rated products with associated equipment.

All information subject to change without notice. All responsibility for the use of products from other suppliers and the possible modifications of their characteristics is disclaimed.

Compatibles barriers

0.25 W ASCO pilot 302		
Suppliers	Barrier reference	24 V with LED
Pepperl + Fuchs	KCD0-SD3-Ex1.1045	X
	KCD0-SD3-Ex1.1245	X
	KCD0-SD-EX1.1245	X
	KCD2-SLD-EX1.1045	X
	KCD2-SLD-EX1.1065	X
	KCD2-SLD-EX1.1245	X
	KFD0-SD2-EX1.10100	X
	KFD0-SD2-EX1.1045	X
	KFD0-SD2-EX1.1065	X
	KFD0-SD2-EX1.1180	X
	KFD0-SD2-EX2.1045	X
	KFD0-SD2-EX2.1245	X
	KFD2-SL2-EX1	X
	KFD2-SL2-EX1.B	X
	KFD2-SL2-EX1.LK	X
	KFD2-SL2-EX1.LK.1045	X
	KFD2-SL2-EX2	X
	KFD2-SL2-EX2.B	X
	KCD0-SD3-Ex1.1245.SP	X
	KCD0-SD-Ex1.1245.SP	X
	KFD2-SL2-Ex1.LK-Y1	X
	HIC2871	X
	HIC2871A	X
	HIC2873	X
	HIC2877	X
	HIC2883	X
	HID2872	X
	HID2876	X
	LB-2103 AR/ER	X
	LB-2112 AR/ER	X
	FB-2203	X
	FB-2212	X
	FB-2216	X
FB2217	X	
FB6216	X	
FB6217	X	
FB2201	X	
Stahl	9176/ 10- 16- 00s	X
	9176/ 20- 15- 00s 1 canal	X
	9176/ 20- 16- 00s 1 canal	X
	9176/ 20- 17- 00s 1 canal	X
	9176/ 20- 15- 00s 2 canals	X
	9176/ 20- 16- 00s 2 canals	X
	9176/ 20- 17- 00s 2 canals	X
	9175/ 10- 14- 11s	X
	9175/ 10- 16- 11s	X
	9175/ 20- 14- 11s 1 canal	X
	9175/ 20- 16- 11s 1 canal	X
	9175/ 20- 14- 11s 2 canals	X
	9175/ 20- 16- 11s 2 canals	X
	9276/ 10- 21- 40- 00k	X
	9276/ 10- 21- 40- 00s	X
	9276/ 10- 21- 60- 00k	X
	9276/ 10- 21- 60- 00s	X
	9276/ 10- 24- 48- 00k	X
	9276/ 10- 24- 48- 00s	X
	9275/ 10- 24- 48- 11s	X
Turck	IMX12-DO01-1U-1U-PR/ 24VDC/CC	X
	IM72-22EX/L	X
	MX12-DO01-1U-1U-0/24VDC/CC	X
	IMX12-DO01-2U-2U-0/ 24VDC	X
	IMX12-DO01-2U-2U-0/ 24VDC/CC	X
	IMX12-DO01-2U-2U-PR/ 24VDC	X
	IMX12-DO01-1U-1U-0/ 24VDC	X
	IMC-DO-11EX/L	X
	IM72-11EX/L	X
	IMX12-DO01-2U-2U-PR/ 24VDC/CC	X

In accordance with the zone classification and the national legislation of each country, apply the certification procedures for the connection of IS-rated products with associated equipment.

All information subject to change without notice. All responsibility for the use of products from other suppliers and the possible modifications of their characteristics is disclaimed.

00163GB-2021/R01
Availability, design and specifications are subject to change without notice. All rights reserved.

Compatibles barriers

0.25 W ASCO pilot 302		
Suppliers	Barrier reference	24 V with LED
Siemens	6ES71327GD100AB0 1 way	X
	6ES71327GD100AB0 2 ways	X
	6ES71327GD210AB0 1 way	X
	6ES71327GD210AB0 2 ways	X
	6ES71327GD300AB0	X
	6ES71327RD010AB0	X
	6ES71327RD220AB0 1 way	X
	6ES71327RD220AB0 2 ways	X
	6ES71327GD000AB0	X
Phéonix contact	MACX MCR-EX-SL-SD-21-60-LP-SP - 2924100	X
	MACX MCR-EX-SL-SD-21-60-LP - 2865515	X
	MACX MCR-EX-SL-SD-24-48-LP - 2865609	X
	MACX MCR-EX-SL-SD-21-40-LP-SP - 2924139	X
	MACX MCR-EX-SL-SD-21-40-LP - 2865764	X
	MACX MCR-EX-SL-SD-24-48-LP-SP - 2924126	X
	MACX MCR-EX-SL-SD-24-48-LFD-SP - 2906156	X
	MACX MCR-EX-SL-SD-24-48-LFD - 2906155	X
	MACX MCR-EX-SL-SD-23-48-LFD-SP - 2924870	X
	MACX MCR-EX-SL-SD-23-48-LFD - 2924867	X
	PI-EX-SD-21-40 - 2865913	X
	PI-EX-SD-24-48 - 2865298	X
	PI-EX-SD-21-60 - 2865188	X
WAGO	750-535	X
	750-535/040-000	X
	750-539	X

00163CB-2021/R01
Availability, design and specifications are subject to change without notice. All rights reserved.

In accordance with the zone classification and the national legislation of each country, apply the certification procedures for the connection of IS-rated products with associated equipment.
All information subject to change without notice. All responsibility for the use of products from other suppliers and the possible modifications of their characteristics is disclaimed.

Dimensions (mm), Weight (kg)



TYPE 01

IEC 335 / DIN 43650
EN/IEC 60079-11/26
II 1 G Ex ia IIC T6 to T4 Ga
II 1 D Ex ia IIIC T85°C to T135°C Da

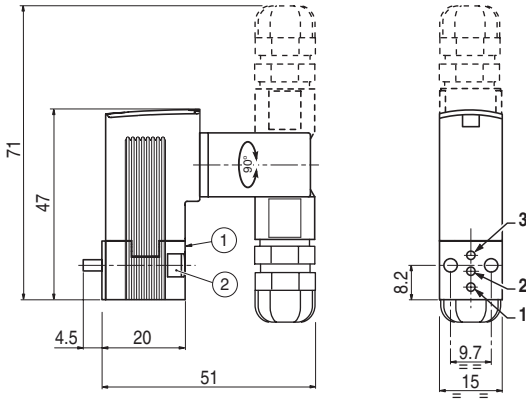

Pneumatic base: ISO 15218
(CNOMO E06.36.120N, size 15)

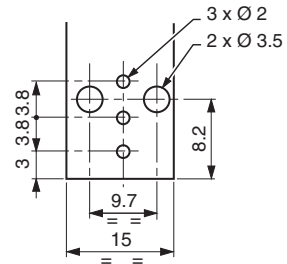

Type	Weight ⁽¹⁾
01	0.052

- ① Manual operator location
- ② Mounting: 2 M3 x 20 screws

⁽¹⁾ Including connector.

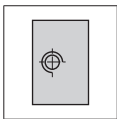

Single subbase
Brass

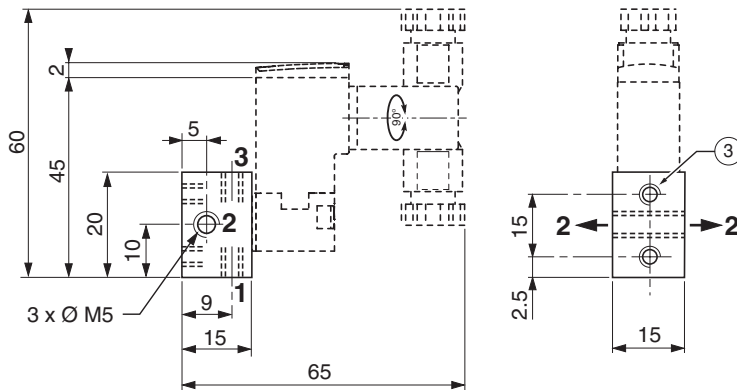

Orifice (2) can be connected on the left or on the right of the subbase.

Material	Catalog number	Weight ⁽²⁾
brass	30300001	0.034

- ③ Mounting: 2 holes M3, depth 4.5

⁽²⁾ subbase alone