

FEATURES

- Very low voltage noise: 1 nV/√Hz maximum at 100 Hz**
- Excellent current gain match: 0.5% typical**
- Low offset voltage (V_{OS}): 200 μ V maximum**
- Outstanding offset voltage drift: 0.03 μ V/°C typical**
- High gain bandwidth product: 200 MHz**

PIN CONFIGURATION

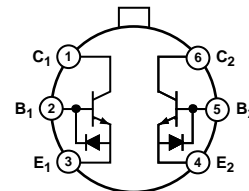

- NOTE**
1. SUBSTRATE IS CONNECTED TO CASE ON TO-78 PACKAGE.
 2. SUBSTRATE IS NORMALLY CONNECTED TO THE MOST NEGATIVE CIRCUIT POTENTIAL, BUT CAN BE FLOATED.

09044-001

Figure 1. 6-Lead TO-78

GENERAL DESCRIPTION

The **MAT12** is a dual, NPN-matched transistor pair that is specifically designed to meet the requirements of ultralow noise audio systems.

With its extremely low input base spreading resistance ($r_{bb'}$ is typically 28 Ω) and high current gain (h_{FE} typically exceeds 600 at $I_C = 1$ mA), the **MAT12** can achieve outstanding signal-to-noise ratios. The high current gain results in superior performance compared to systems incorporating commercially available monolithic amplifiers.

Excellent matching of the current gain (Δh_{FE}) to about 0.5% and low V_{OS} of less than 10 μ V typical make the **MAT12** ideal for symmetrically balanced designs, which reduce high-order amplifier harmonic distortion.

Stability of the matching parameters is guaranteed by protection diodes across the base emitter junction. These diodes prevent

degradation of beta and matching characteristics due to reverse biasing of the base emitter junction.

The **MAT12** is also an ideal choice for accurate and reliable current biasing and mirroring circuits. Furthermore, because the accuracy of a current mirror degrades exponentially with mismatches of V_{BE} between transistor pairs, the low V_{OS} of the **MAT12** does not need offset trimming in most circuit applications.

The **MAT12** is a good replacement for the MAT02, and its performance and characteristics are guaranteed over the extended temperature range of -40°C to $+85^\circ\text{C}$.

TABLE OF CONTENTS

Features	1	Thermal Resistance	4
Pin Configuration	1	ESD Caution	4
General Description	1	Typical Performance Characteristics	5
Revision History	2	Applications Information	8
Specifications	3	Fast Logarithmic Amplifier	8
Electrical Characteristics	3	Outline Dimensions	10
Absolute Maximum Ratings	4	Ordering Guide	10

REVISION HISTORY

1/14—Rev. 0 to Rev. A

Change to Gain Bandwidth Product Parameter..... 3

7/10—Revision 0: Initial Version

SPECIFICATIONS

ELECTRICAL CHARACTERISTICS

$V_{CB} = 15\text{ V}$, $I_O = 10\text{ }\mu\text{A}$, $T_A = 25^\circ\text{C}$, unless otherwise specified.

Table 1.

Parameter	Symbol	Test Conditions/Comments	Min	Typ	Max	Unit
DC AND AC CHARACTERISTICS						
Current Gain ¹	h_{FE}	$I_C = 1\text{ mA}$ $-40^\circ\text{C} \leq T_A \leq +85^\circ\text{C}$	300	605		
		$I_C = 10\text{ }\mu\text{A}$ $-40^\circ\text{C} \leq T_A \leq +85^\circ\text{C}$	300			
			200	550		
			200			
Current Gain Match ²	Δh_{FE}	$10\text{ }\mu\text{A} \leq I_C \leq 1\text{ mA}$		0.5	5	%
Noise Voltage Density ³	e_N	$I_C = 1\text{ mA}$, $V_{CB} = 0\text{ V}$ $f_O = 10\text{ Hz}$		1.6	2	nV/ $\sqrt{\text{Hz}}$
		$f_O = 100\text{ Hz}$		0.9	1	nV/ $\sqrt{\text{Hz}}$
		$f_O = 1\text{ kHz}$		0.85	1	nV/ $\sqrt{\text{Hz}}$
		$f_O = 10\text{ kHz}$		0.85	1	nV/ $\sqrt{\text{Hz}}$
Low Frequency Noise (0.1 Hz to 10 Hz)	$e_N\text{ p-p}$	$I_C = 1\text{ mA}$		0.4		$\mu\text{V p-p}$
Offset Voltage	V_{OS}	$V_{CB} = 0\text{ V}$, $I_C = 1\text{ mA}$ $-40^\circ\text{C} \leq T_A \leq +85^\circ\text{C}$		10	200	μV
					220	μV
Offset Voltage Change vs. V_{CB}	$\Delta V_{OS}/\Delta V_{CB}$	$0\text{ V} \leq V_{CB} \leq V_{MAX}$ ⁴ , $1\text{ }\mu\text{A} \leq I_C \leq 1\text{ mA}$ ⁵		10	50	μV
Offset Voltage Change vs. I_C	$\Delta V_{OS}/\Delta I_C$	$1\text{ }\mu\text{A} \leq I_C \leq 1\text{ mA}$ ⁵ , $V_{CB} = 0\text{ V}$		5	70	μV
Offset Voltage Drift	$\Delta V_{OS}/\Delta T$	$-40^\circ\text{C} \leq T_A \leq +85^\circ\text{C}$ $-40^\circ\text{C} \leq T_A \leq +85^\circ\text{C}$, V_{OS} trimmed to 0 V		0.08	1	$\mu\text{V}/^\circ\text{C}$
				0.03	0.3	$\mu\text{V}/^\circ\text{C}$
Breakdown Voltage, Collector to Emitter	BV_{CEO}		40			V
Gain Bandwidth Product	f_T	$I_C = 10\text{ mA}$, $V_{CE} = 10\text{ V}$		200		MHz
Collector-to-Base Leakage Current	I_{CBO}	$V_{CB} = V_{MAX}$ $-40^\circ\text{C} \leq T_A \leq +85^\circ\text{C}$		25	500	pA
				3		nA
Collector-to-Collector Leakage Current ^{6, 7}	I_{CC}	$V_{CC} = V_{MAX}$ $-40^\circ\text{C} \leq T_A \leq +85^\circ\text{C}$		35	500	pA
				4		nA
Collector-to-Emitter Leakage Current ^{6, 7}	I_{CES}	$V_{CE} = V_{MAX}$, $V_{BE} = 0\text{ V}$ $-40^\circ\text{C} \leq T_A \leq +85^\circ\text{C}$		35	500	pA
				4		nA
Input Bias Current	I_B	$I_C = 10\text{ }\mu\text{A}$ $-40^\circ\text{C} \leq T_A \leq +85^\circ\text{C}$			50	nA
					50	nA
Input Offset Current	I_{OS}	$I_C = 10\text{ }\mu\text{A}$ $-40^\circ\text{C} \leq T_A \leq +85^\circ\text{C}$			6.2	nA
					13	nA
Input Offset Current Drift ⁶	$\Delta I_{OS}/\Delta T$	$I_C = 10\text{ }\mu\text{A}$, $-40^\circ\text{C} \leq T_A \leq +85^\circ\text{C}$		40	150	pA/ $^\circ\text{C}$
Collector Saturation Voltage	$V_{CE(SAT)}$	$I_C = 1\text{ mA}$, $I_B = 100\text{ }\mu\text{A}$		0.05	0.2	V
Output Capacitance	C_{OB}	$V_{CB} = 15\text{ V}$, $I_E = 0\text{ }\mu\text{A}$		23		pF
Bulk Resistance ⁶	R_{BE}	$10\text{ }\mu\text{A} \leq I_C \leq 10\text{ mA}$		0.3	1.6	Ω
Collector-to-Collector Capacitance	C_{CC}	$V_{CC} = 0\text{ V}$		35		pF

¹ Current gain is guaranteed with collector-to-base voltage (V_{CB}) swept from 0 V to V_{MAX} at the indicated collector currents.

² Current gain match (Δh_{FE}) is defined as follows: $\Delta h_{FE} = (100(\Delta I_B)/(h_{FE\text{ min}})/I_C)$.

³ Noise voltage density is guaranteed, but not 100% tested.

⁴ This is the maximum change in V_{OS} as V_{CB} is swept from 0 V to 40 V.

⁵ Measured at $I_C = 10\text{ }\mu\text{A}$ and guaranteed by design over the specified range of I_C .

⁶ Guaranteed by design.

⁷ I_{CC} and I_{CES} are verified by the measurement of I_{CBO} .

ABSOLUTE MAXIMUM RATINGS

Table 2.

Parameter	Rating
Breakdown Voltage of Collector-to-Base Voltage (BV_{CBO})	40 V
Breakdown Voltage of Collector-to-Emitter Voltage (BV_{CEO})	40 V
Breakdown Voltage of Collector-to-Collector Voltage (BV_{CC})	40 V
Breakdown Voltage of Emitter-to-Emitter Voltage (BV_{EE})	40 V
Collector Current (I_C)	20 mA
Emitter Current (I_E)	20 mA
Storage Temperature Range	-65°C to +150°C
Operating Temperature Range	-40°C to +85°C
Junction Temperature Range	-65°C to +150°C
Lead Temperature (Soldering, 60 sec)	300°C

Stresses above those listed under Absolute Maximum Ratings may cause permanent damage to the device. This is a stress rating only; functional operation of the device at these or any other conditions above those indicated in the operational section of this specification is not implied. Exposure to absolute maximum rating conditions for extended periods may affect device reliability.

THERMAL RESISTANCE

θ_{JA} is specified for the worst-case conditions, that is, a device soldered in a circuit board for surface-mount packages.

Table 3. Thermal Resistance

Package Type	θ_{JA}	θ_{JC}	Unit
6-Lead TO-78	150	45	°C/W

ESD CAUTION



ESD (electrostatic discharge) sensitive device. Charged devices and circuit boards can discharge without detection. Although this product features patented or proprietary protection circuitry, damage may occur on devices subjected to high energy ESD. Therefore, proper ESD precautions should be taken to avoid performance degradation or loss of functionality.

TYPICAL PERFORMANCE CHARACTERISTICS

$T_A = 25^\circ\text{C}$, $V_{CE} = 5\text{ V}$, unless otherwise specified.

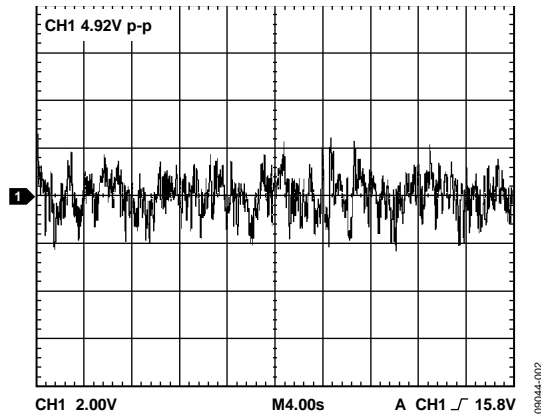

Figure 2. Low Frequency Noise (0.1 Hz to 10 Hz), $I_C = 1\text{ mA}$, Gain = 10,000,000

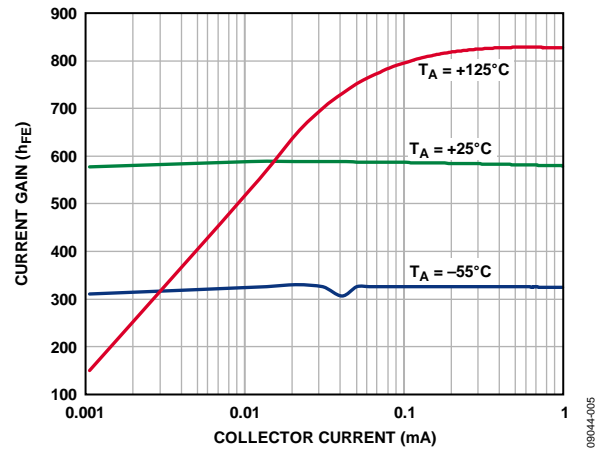

Figure 5. Current Gain vs. Collector Current ($V_{CB} = 0\text{ V}$)

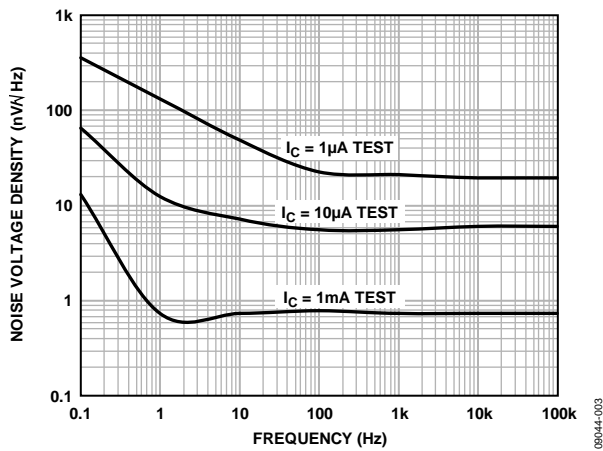

Figure 3. Noise Voltage Density vs. Frequency

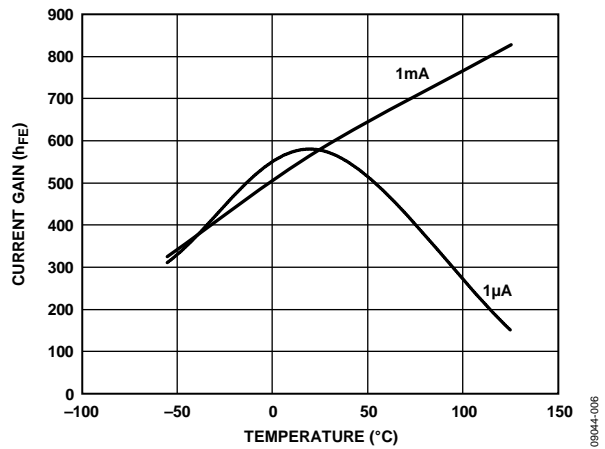

Figure 6. Current Gain vs. Temperature (Excludes I_{CB0})

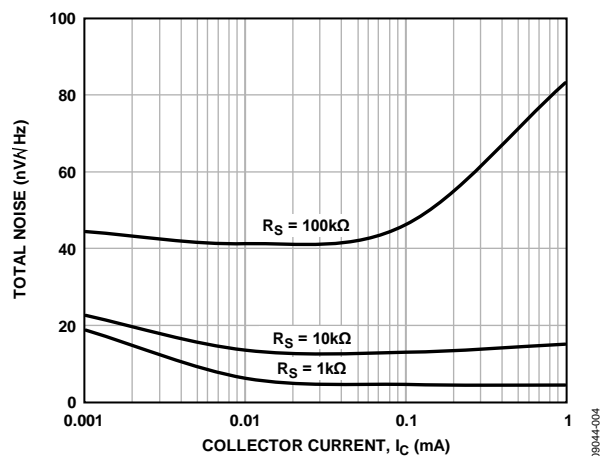

Figure 4. Total Noise vs. Collector Current, $f = 1\text{ kHz}$

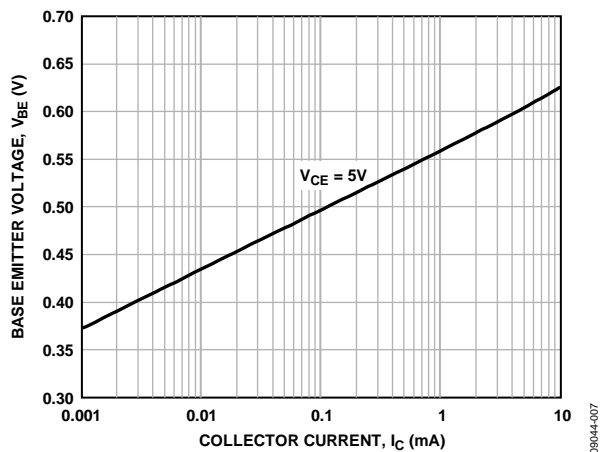

Figure 7. Base Emitter Voltage vs. Collector Current

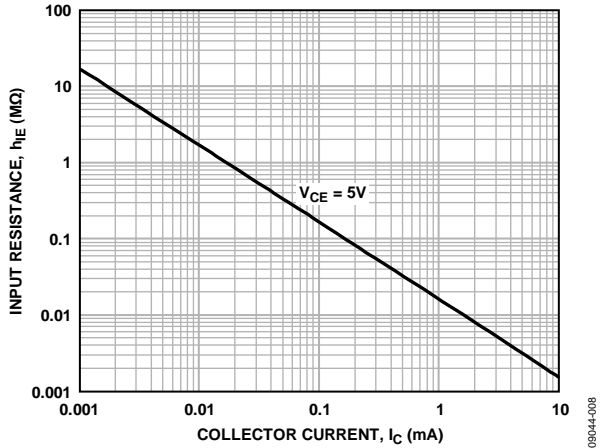

Figure 8. Small Signal Input Resistance vs. Collector Current

09044-008

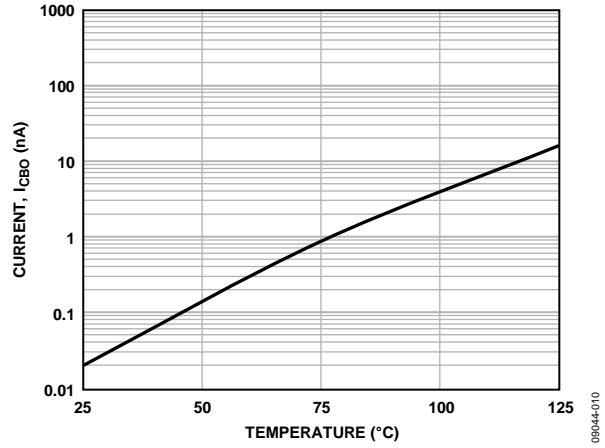

Figure 11. Collector-to-Base Leakage Current vs. Temperature

09044-010

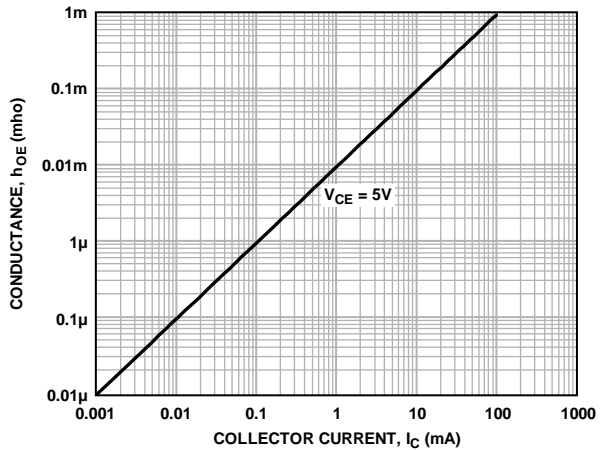

Figure 9. Small Signal Output Conductance vs. Collector Current

09044-009

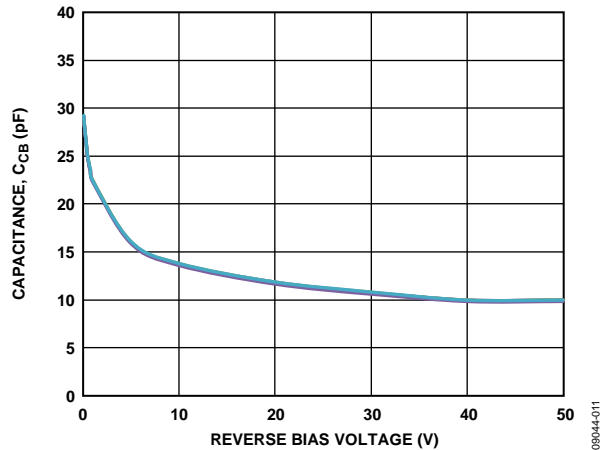

Figure 12. Collector-to-Base Capacitance vs. Reverse Bias Voltage

09044-011

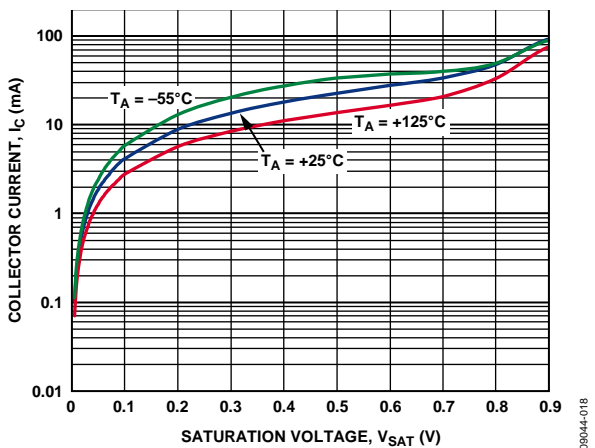

Figure 10. Collector Current vs. Saturation Voltage

09044-018

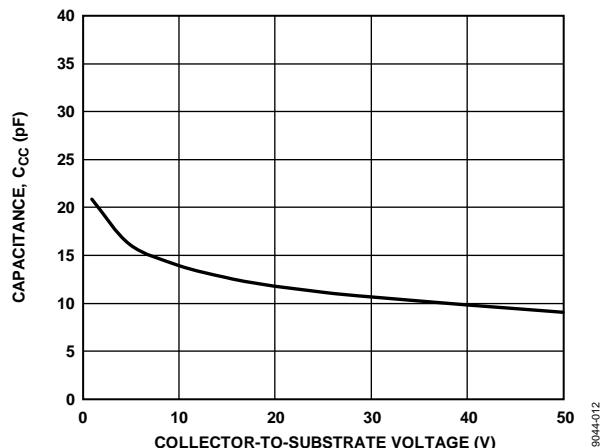

Figure 13. Collector-to-Collector Capacitance vs. Collector-to-Substrate Voltage

09044-012

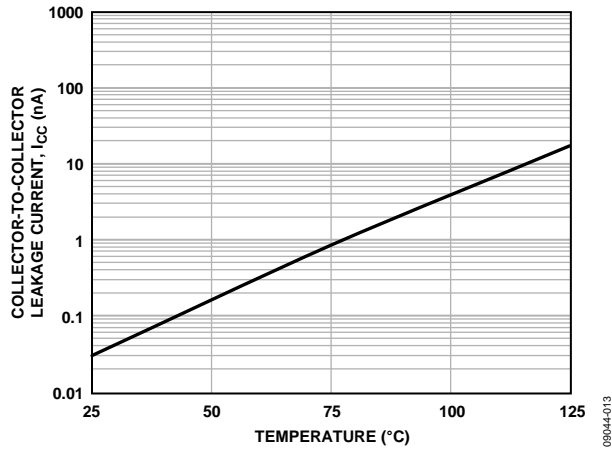

Figure 14. Collector-to-Collector Leakage Current vs. Temperature

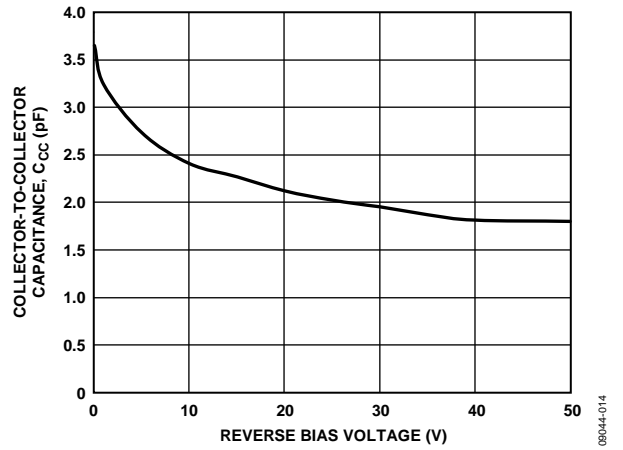

Figure 15. Collector-to-Collector Capacitance vs. Reverse Bias Voltage

APPLICATIONS INFORMATION

FAST LOGARITHMIC AMPLIFIER

The circuit of Figure 16 is a modification of a standard logarithmic amplifier configuration. Running the **MAT12** at 2.5 mA per side (full scale) allows for a fast response with a wide dynamic range. The circuit has a seven decade current range and a five decade voltage range, and it is capable of 2.5 μs settling time to 1% with a 1 V to 10 V step. The output follows the equation:

$$V_O = \frac{R_3 + R_2}{R_2} \frac{kT}{q} \ln \frac{V_{REF}}{V_{IN}}$$

To compensate for the temperature dependence of the kT/q term, a resistor with a positive 0.35%/°C temperature coefficient is selected for R_2 . The output is inverted with respect to the input and is nominally -1 V/decade using the component values indicated.

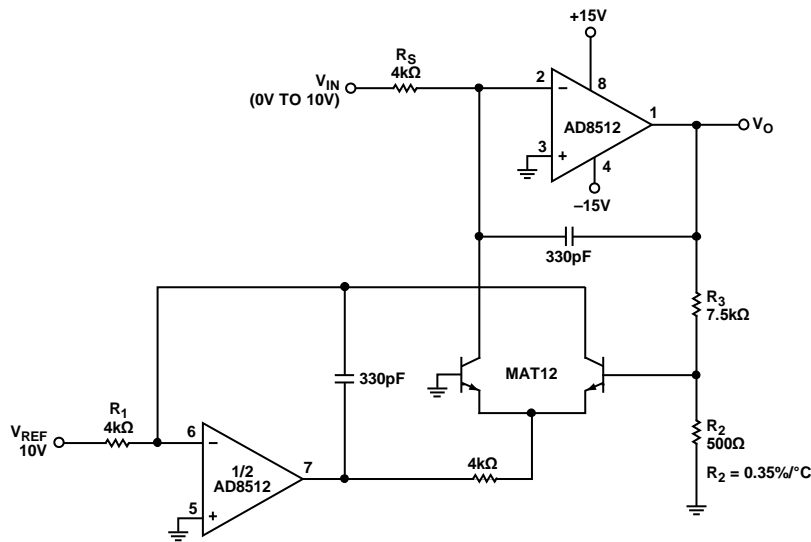

Figure 16. Fast Logarithmic Amplifier

09044-015

LOG CONFORMANCE TESTING

The log conformance of the MAT12 is tested using the circuit shown in Figure 18. The circuit employs a dual transdiode logarithmic converter operating at a fixed ratio of collector currents that are swept over a 10:1 range. The output of each transdiode converter is the V_{BE} of the transistor plus an error term, which is the product of the collector current and r_{BE} , the bulk emitter resistance. The difference of the V_{BE} is amplified at a gain of $\times 100$ by the AMP02 instrumentation amplifier. The differential emitter base voltage (ΔV_{BE}) consists of a temperature-dependent dc level plus an ac error voltage, which is the deviation from true log conformity as the collector currents vary.

The output of the transdiode logarithmic converter comes from the following idealized intrinsic transistor equation (for silicon)

$$V_{BE} = \frac{kT}{q} \ln \frac{I_C}{I_S} \tag{1}$$

where:

- k is Boltzmann's constant (1.38062×10^{-23} J/K).
- q is the unit electron charge (1.60219×10^{-19} C).
- T is the absolute temperature, K ($= ^\circ C + 273.2$).
- I_S is the extrapolated current for $V_{BE} \rightarrow 0$ (V_{BE} tending to zero).
- I_C is the collector current.

An error term must be added to Equation 1 to allow for the bulk resistance (r_{BE}) of the transistor. Error due to the op amp input current is limited by use of the AD8512 dual op amp. The resulting AMP02 input is:

$$\Delta V_{BE} = \frac{kT}{q} = \ln \frac{I_{C1}}{I_{C2}} + I_{C1}r_{BE1} - I_{C2}r_{BE2} \tag{2}$$

A ramp function that sweeps from 1 V to 10 V is converted by the op amps to a collector current ramp through each transistor.

Because I_{C1} is made equal to 10 I_{C2} , and assuming $T_A = 25^\circ C$, Equation 2 becomes

$$\Delta V_{BE} = 59 \text{ mV} + 0.9 I_{C1} r_{BE} (\Delta r_{BE} \sim 0)$$

As viewed on an oscilloscope, the change in ΔV_{BE} for a 10:1 change in I_C is shown in Figure 17.

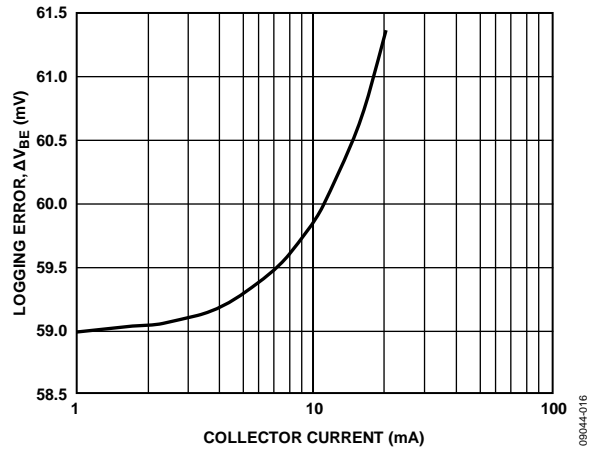

Figure 17. Emitter Base, Log Conformity

With the oscilloscope ac-coupled, the temperature dependent term becomes a dc offset and the trace represents the deviation from true log conformity. The bulk resistance can be calculated from the voltage deviation, ΔV_O , and the change in collector current (9 mA):

$$r_{BE} = \frac{\Delta V_O}{9 \text{ mA}} \times \frac{1}{100} \tag{3}$$

This procedure solves for r_{BE} for Side A. Switching R_1 and R_2 provides the r_{BE} for Side B. Differential r_{BE} is found by making $R_1 = R_2$.

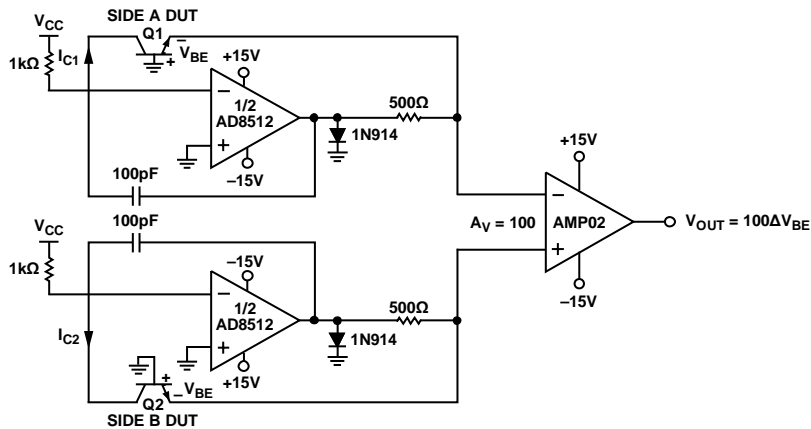

Figure 18. Log Conformance Circuit

NOTES

NOTES