Telemecanique Sensors Detection components

Panorama



Simply easy!™

Telemecanique Sensors

Simply easy!™

Founded over 90 years ago, **Telemecanique Sensors** is specialized in sensors and sensor-related technology.

As a **global leader** in the sensors business, we help our customers select the right technology to get the best performance and reliability from their machines.



Focused on 3 core values – **Simplicity, Proximity and Expertise** – we have become experts in factory automation sensors as well as specialists in demanding applications, making our customers' lives "Simply easy!"

Visit our website and discover our full offer on www.tesensors.com

SPOTLIGHT: Wireless

Limit switches: XC Wireless

Choose : 1 > 2 > 3 > 4 > Reference

Body Head Contact Connection

XC MW	Snap Action	Metal Roller Plunger	Metal End Plunger	Plastic Roller Lever	Metal Roller Lever
	One way pulsed wireless transmission	XCMW102	XCMW110	XCMW115	XCMW116
					Adjustable Length Plastic Roller Lever
					XCMW145

Receivers

Choose : 1 > 2 > 3 > Reference

Body Connection Output function

ZBRR	4xPNP	2xRelays	XZBW
32 Transmitters	ZBRC	ZBRRD	2 Transmitters
			XZBWR2STT24

Radio transmitter

Connects to any sensor or switch!

NO
2-way continuous Wireless transmission
XZBWE112A24

Pressure switches: XM Range

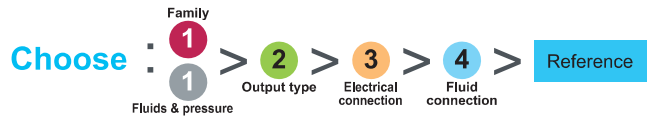

XMLA / XMLB Electromechanical		Hydraulic oils, air, fresh water, sea water / Temp. : up to 70° C							
Screw terminal		1 C/O single pole contact fixed differential			1 C/O single pole contact adjustable differential				
		Bar	psi	ISO M20	Pg13	DIN connector	ISO M20	Pg13	DIN connector
	-1	-14.5	XMLAM01V2S12	XMLAM01V2S11	XMLAM01V2C11	XMLBM02V2S12	XMLBM02V2S11	XMLBM02V2C11	
	2,5	36,3	XMLA002A2S12	XMLA002A2S11	XMLA002A2C11	XMLB002A2S12	XMLB002A2S11	XMLB002A2C11	
	4	58	XMLA004A2S12	XMLA004A2S11	XMLA004A2C11	XMLB004A2S12	XMLB004A2S11	XMLB004A2C11	
	10	145	XMLA010A2S12	XMLA010A2S11	XMLA010A2C11	XMLB010A2S12	XMLB010A2S11	XMLB010A2C11	
	20	290	XMLA020A2S12	XMLA020A2S11	XMLA020A2C11	XMLB020A2S12	XMLB020A2S11	XMLB020A2C11	
	35	508	XMLA035A2S12	XMLA035A2S11	XMLA035A2C11	XMLB035A2S12	XMLB035A2S11	XMLB035A2C11	
G 1/4 (female)		Hydraulic oils / Temp. : up to 160° C							
		Bar	psi	ISO M20	Pg13	DIN connector	ISO M20	Pg13	DIN connector
		1	14.5	XMLA001R2S12	XMLA001R2S11	XMLA001R2C11	XMLB001R2S12	XMLB001R2S11	XMLB001R2C11
		70	1015	XMLA070D2S12	XMLA070D2S11	XMLA070D2C11	XMLB070D2S12	XMLB070D2S11	XMLB070D2C11
		160	2320	XMLA160D2S12	XMLA160D2S11	XMLA160D2C11	XMLB160D2S12	XMLB160D2S11	XMLB160D2C11
		300	4350	XMLA300D2S12	XMLA300D2S11	XMLA300D2C11	XMLB300D2S12	XMLB300D2S11	XMLB300D2C11
		500	7250	XMLA500D2S12	XMLA500D2S11	XMLA500D2C11	XMLB500D2S12	XMLB500D2S11	XMLB500D2C11

XMLR Electronic + Display		Hydraulic oils, air, fresh water, refrigerant fluids					
M12 4 pin or 5 pin		-20... +80° C					
		Analog output		Analog + 2 switching outputs		Analog + 2 switching outputs	
		4...20 mA		0...10 V		PNP - NO/NC programmable	
		4...20 mA		0...10 V		4...20 mA	
	-1	-14.5	XMLRM01G0T25	XMLRM01G0T75	XMLRM01G2P25		
	1	14.5	XMLR001G0T25	XMLR001G0T75	XMLR010G2P25		
	2.5	35.2	XMLR2D5G0T25	XMLR2D5G0T75	XMLR016G2P25		
	10	145	XMLR010G0T25	XMLR010G0T75	XMLR040G2P25		
	16	232	XMLR016G0T25	XMLR016G0T75	XMLR250M2P25		
	25	362	XMLR025G0T25	XMLR025G0T75	XMLR400M2P25		
	40	580	XMLR040G0T25	XMLR040G0T75			
	100	1450	XMLR100M0T25	XMLR100M0T75			
	160	2320	XMLR160M0T25	XMLR160M0T75			
	250	3625	XMLR250M0T25	XMLR250M0T75			
	400	5800	XMLR400M0T25	XMLR400M0T75			
	600	8700	XMLR600M0T25	XMLR600M0T75			
G 1/4A (female)		Hydraulic oils, air, fresh water, refrigerant fluids					
		-20... +80° C					
		Analog + switching output		2 switching outputs		PNP - NO/NC programmable	
		PNP - NO/NC programmable		PNP - NO/NC programmable		PNP - NO/NC programmable	
		4...20 mA		0...10 V		4...20 mA	
		Bar	psi	4...20 mA	0...10 V	2 switching outputs	
		-1	-14.5	XMLRM01G1P25	XMLRM01G1P75	XMLRM01G2P05	
		1	14.5	XMLR001G1P25	XMLR001G1P75	XMLR001G2P05	
		2.5	35.2	XMLR2D5G1P25	XMLR2D5G1P75	XMLR2D5G2P05	
		10	145	XMLR010G1P25	XMLR010G1P75	XMLR010G2P05	
		16	232	XMLR016G1P25	XMLR016G1P75	XMLR016G2P05	
		25	362	XMLR025G1P25	XMLR025G1P75	XMLR025G2P05	
		40	580	XMLR040G1P25	XMLR040G1P75	XMLR040G2P05	
		100	1450	XMLR100M1P25	XMLR100M1P75	XMLR100M2P05	
		160	2320	XMLR160M1P25	XMLR160M1P75	XMLR160M2P05	
		250	3625	XMLR250M1P25	XMLR250M1P75	XMLR250M2P05	
		400	5800	XMLR400M1P25	XMLR400M1P75	XMLR400M2P05	
		600	8700	XMLR600M1P25	XMLR600MP75	XMLR600M2P05	

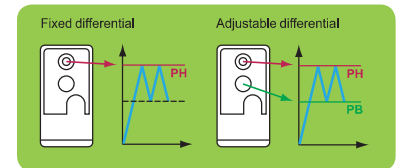

Cabling XM			Connectors (female)				PUR pre wired connectors (female)*				PUR Jumper cables							
			straight		elbowed		straight		elbowed		elbowed PNP LED		M12 (female)		M12 (male)			
(1)	4 pin	XZCC12FDM40B	XZCC12FCM40B	M12	2 m	XZCP1141L2	XZCP1241L2	XZCP1340L2	M12 (female)	4 pin	1 m	XZCR1511041C1	XZCR1512041C1	M12 (male)	4 pin	1 m	XZCR1511041C1	XZCR1512041C1
(2)	4 pin	XZCC12FDP40B	XZCC12FCP40B		5 m	XZCP1141L5	XZCP1241L5	XZCP1340L5		4 pin	2 m	XZCR1511041C2	XZCR1512041C2					
(1)	5 pin	XZCC12FDM50B	XZCC12FCM50B		10 m	XZCP1141L10	XZCP1241L10	XZCP1340L10										

(1) Steel ring (2) Plastic ring

* For a PVC cable, add the letter V after the P. Example: XZCPxxxxx become XZCPVxxxxx

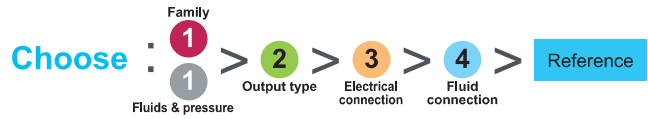

Pressure switches: XM Range



XMLP Electronic transmitter		Hydraulic oils, air, fresh water				
M12 4 pin (male)		-30...+85° C				
		Analog output				
		Bar	psi	4...20 mA	0...10 V	0.5...4.5 V
		-1	-14.5	XMLPM00GD21F	XMLPM00GD71F	XMLPM00GD11F
		1	14.5	XMLP001GD21F	XMLP001GD71F	XMLP001GD11F
		6	87	XMLP006GD21F	XMLP006GD71F	XMLP006GD11F
		10	145	XMLP010BD21F	XMLP010BD71F	XMLP010BD11F
		16	232	XMLP016BD21F	XMLP016BD71F	XMLP016BD11F
		25	362	XMLP025BD21F	XMLP025BD71F	XMLP025BD11F
		40	580	XMLP040BD21F	XMLP040BD71F	XMLP040BD11F
		60	870	XMLP060BD21F	XMLP060BD71F	XMLP060BD11F
		100	1450	XMLP100BD21F	XMLP100BD71F	XMLP100BD11F
		160	2320	XMLP160BD21F	XMLP160BD71F	XMLP160BD11F
		250	3625	XMLP250BD21F	XMLP250BD71F	XMLP250BD11F
		400	5800	XMLP400BD21F	XMLP400BD71F	XMLP400BD11F
G 1/4A (male)		600	8700	XMLP600BD21F	XMLP600BD71F	XMLP600BD11F

ZMLP Display and switch	4-20 mA analog + switching output		2 switching outputs
M12 4 pin (male)	NO/NC Programmable		NO/NC Programmable
PNP	Window	Hysteresis	Fixed hysteresis
	ZMLPA1P2SW	ZMLPA1P2SH	ZMLPA2P0SH
M12 4 pin (female)	Quick mounting bracket	Horizontal plan XMLPZLH01	Vertical plan or pipe XMLPZLV01

Only usable with 4-20mA analog output XMLP electronic transmitter

Cabling XM

	Connectors (female)		PUR pre wired connectors (female)*			PUR Jumper cables		
	M12	straight	straight	elbowed	elbowed PNP LED	M12 (female)	straight	elbowed
(1)	4 pin	XZCC12FDM40B	XZCP1141L2	XZCP1241L2	XZCP1340L2	M12 (male)	straight	straight
(2)	4 pin	XZCC12FDP40B	XZCP1141L5	XZCP1241L5	XZCP1340L5	4 pin	1 m	XZCR1511041C1
(1)	5 pin	XZCC12FDM50B	XZCP1141L10	XZCP1241L10	XZCP1340L10	2 m	XZCR1511041C2	XZCR1512041C2

(1) Steel ring (2) Plastic ring

* For a PVC cable, add the letter V after the P. Example: XZCPxxxxx become XZCPVxxxxx

Limit switches: XC Range

See Page 2 for
XC Wireless SPOTLIGHT!

Choose: **1** > **2** > **3** > **4** > Reference

Body Head Contact Connection



XCKD Metal	NO+NC Snap	M16	XCKD2110P16	XCKD2102P16	XCKD2121P16	XCKD2106P16	XCKD2118P16	XCKD2145P16
		Pg11	XCKD2110G11	XCKD2102G11	XCKD2121G11	XCKD2106G11	XCKD2118G11	XCKD2145G11
		M12 5P	XCKD2110M12	XCKD2102M12	XCKD2121M12	XCKD2106M12	XCKD2118M12	XCKD2145M12
XCKP Plastic	NO+NC Snap	M16	XCKP2110P16	XCKP2102P16	XCKP2121P16	XCKP2106P16	XCKP2118P16	XCKP2145P16
		Pg11	XCKP2110G11	XCKP2102G11	XCKP2121G11	XCKP2106G11	XCKP2118G11	XCKP2145G11
		M12 4P	XCKP2110M12	XCKP2102M12	XCKP2121M12	XCKP2106M12	XCKP2118M12	XCKP2145M12
XCKT Plastic	NO+NC Snap	M16	XCKT2110P16	XCKT2102P16	XCKT2121P16	XCKT2106P16	XCKT2118P16	XCKT2145P16
		Pg11	XCKT2110G11	XCKT2102G11	XCKT2121G11	XCKT2106G11	XCKT2118G11	XCKT2145G11



XCMD Metal	NO+NC Snap	1 m	XCMD2110L1	XCMD2102L1	XCMD2124L1	XCMD21F0L1	XCMD21F2L1	XCMD2115L1	XCMD2116L1
	NO+NC Slow	1 m	XCMD2510L1	XCMD2502L1	XCMD2524L1	XCMD25F0L1	XCMD25F2L1	XCMD2515L1	XCMD2516L1
	NO+NC Snap	M12 5P	XCMD2110C12	XCMD2102C12	XCMD2124C12	XCMD21F0C12	XCMD21F2C12	XCMD2115C12	XCMD2116C12
	1 C/O Snap	M12 4P	XCMD2110M12	XCMD2102M12	XCMD2124M12	XCMD21F0M12	XCMD21F2M12	XCMD2115M12	XCMD2116M12



XCKM Metal	NO+NC Snap	M20	XCKM110H29	XCKM102H29	XCKM121H29	XCKM115H29	XCKM106H29
		Pg11	XCKM110	XCKM102	XCKM121	XCKM115	XCKM106
XCKL Metal	NO+NC Snap	CG	XCKL110	XCKL102	XCKL121	XCKL115	XCKL106

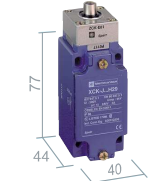

XCKJ Metal	NO+NC Snap	M20	XCKJ161H29	XCKJ167H29	XCKJ10511H29	XCKJ10513H29	XCKJ10541H29	XCKJ10559H29
		Pg13	XCKJ161	XCKJ167	XCKJ10511	XCKJ10513	XCKJ10541	XCKJ10559
		1/2NPT	XCKJ161H7	XCKJ167H7	XCKJ10511H7	XCKJ10513H7	XCKJ10541H7	XCKJ10559H7
		M12 5P	XCKJ161D	XCKJ167D	XCKJ10511D	XCKJ10513D	XCKJ10541D	XCKJ10559D

(1) Plastic roller (2) Steel roller



XCSA Metal			NC+2NO Slow	2NC+NO Slow	3NC Slow	Accessories	
	M20	XCSA502	XCSA702	XCSA802	XCSZ01	XCSZ03	
	Pg13	XCSA501	XCSA701	XCSA801			
	1/2NPT	XCSA503	XCSA703	XCSA803			



XCSA Plastic			NC+NO Slow	2NC Slow	2NO+NC Slow	2NC+NO Slow	2NC+NO Snap	Accessories	
	M16	XCSA592	XCSA792	XCSA892	XCSA992	XCSA492	XCSZ11	XCSZ13	
	Pg11	XCSA591	XCSA791	XCSA891	XCSA991	XCSA491			
	1/2NPT	XCSA593	XCSA793	XCSA893	XCSA993	XCSA493			

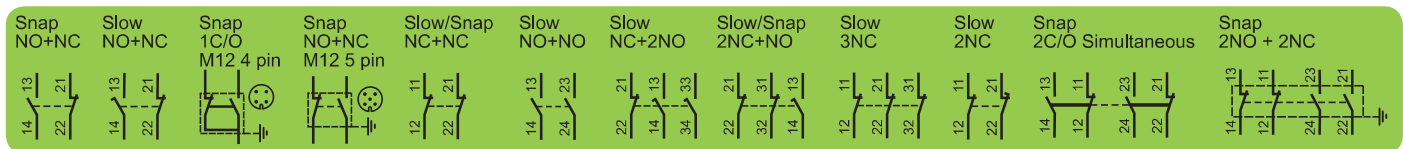

- M16 Tapped M16x1.5 for ISO cable gland
- M20 Tapped M20x1.5 for ISO cable gland
- Pg11 Tapped for a N°11 cable gland
- Pg13 Tapped for a N°13 cable gland
- 1/2NPT Tapped for a 1/2" NPT
- PF1/2 Tapped for a PF1/2"
- M12 5P Connector M12, 5 pin
- M12 4P Connector M12, 4 pin
- CG Tapped with cable gland included

Cabling XC			PUR pre wired connectors (female)*			Connectors (female)		
M12			straight	elbowed	elbowed PNP LED	M12	straight	elbowed
4 pin	2 m	XZCP1141L2	XZCP1241L2	XZCP1340L2	(1) 4 pin	XZCC12FDM40B	XZCC12FCM40B	
	5 m	XZCP1141L5	XZCP1241L5	XZCP1340L5	(2) 4 pin	XZCC12FDP40B	XZCC12FCP40B	
	10 m	XZCP1141L10	XZCP1241L10	XZCP1340L10	(1) 5 pin	XZCC12FDM50B	XZCC12FCM50B	
5 pin	5 m	XZCP1164L5	XZCP1264L5					

(1) Steel ring (2) Plastic ring

*For a PVC cable, add the letter V after the P. Example: XZCPxxxxx become XZCPVxxxxx

Limit switches: XC Range

XCKP / XCKD / XCKT

Plastic / Metal / Plastic

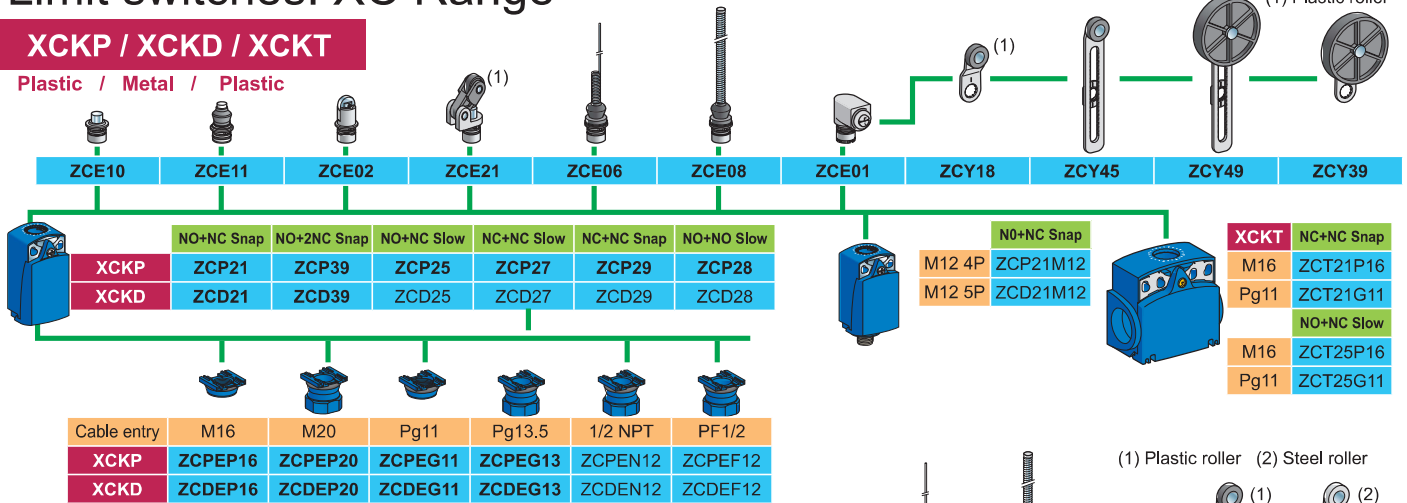

XCMD

Metal

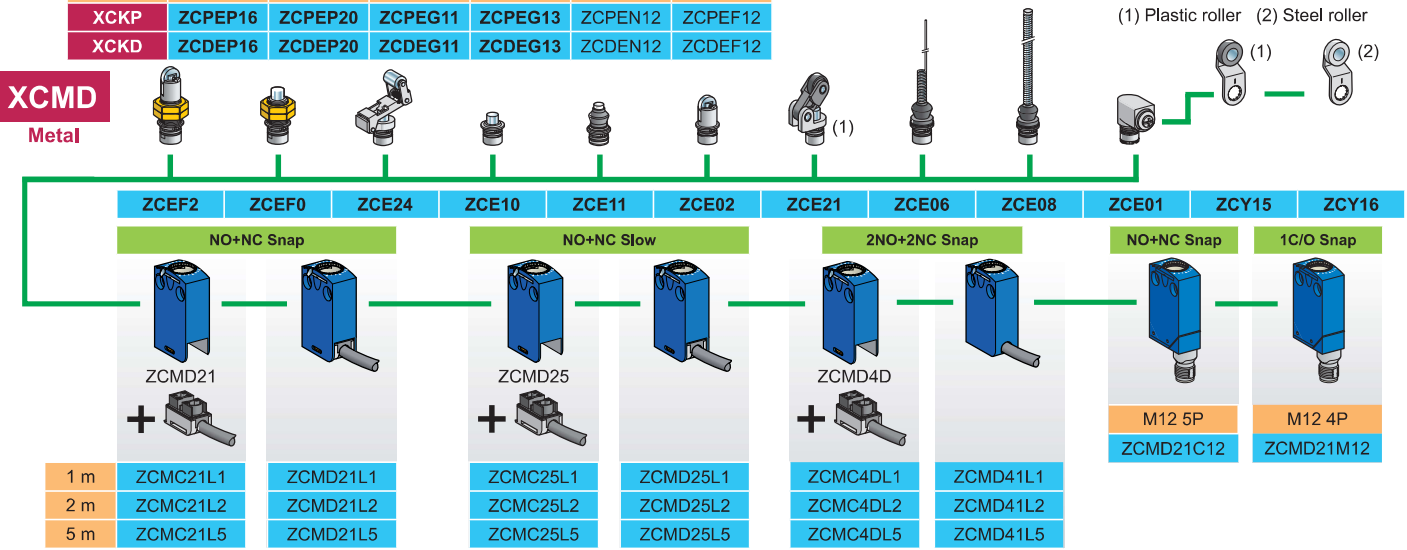

XCKM / XCKL

Metal

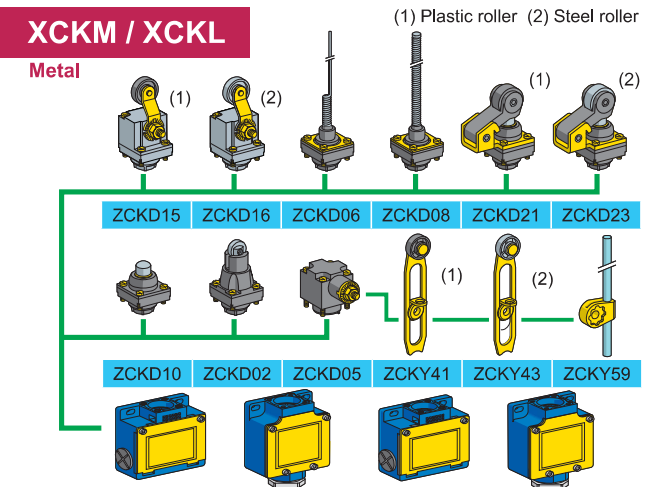

XCKM/XCKL	NO+NC Snap	NO+NC Slow	
3xPg11	ZCKM1	ZCKM5	
3xM20	ZCKM1H29	ZCKM5H29	
PE	ZCKL1	ZCKL5	
1/2 NPT	ZCKL1H7	ZCKL5H7	
XCKS	NO+NC Snap	NO+NC Slow	
Pg13	ZCKS1	ZCKS5	
M20	ZCKS1H29	ZCKS5H29	
XCKJ	NO+NC Snap	NO+NC Slow	2C/O Simult. Snap
Pg13	ZCKJ1	ZCKJ5	ZCKJ2
M20	ZCKJ1H29	ZCKJ5H29	ZCKJ2H29
1/2 NPT	ZCKJ1H7	ZCKJ5H7	ZCKJ2H7
M12 5P	ZCKJ1D	ZCKJ5D	-

XCKJ

Metal

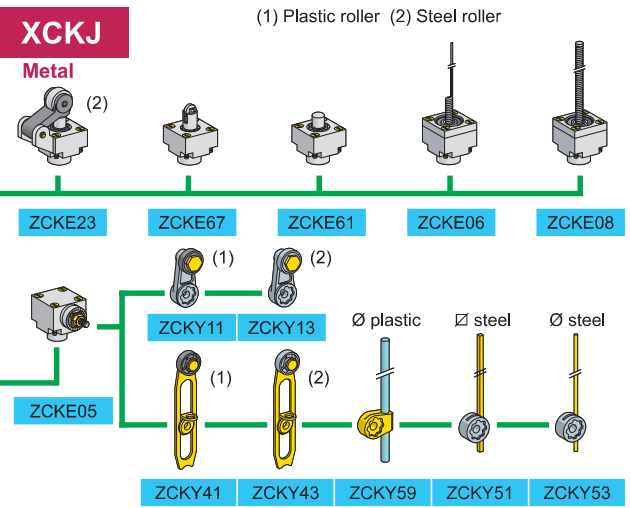

XCKS

Plastic

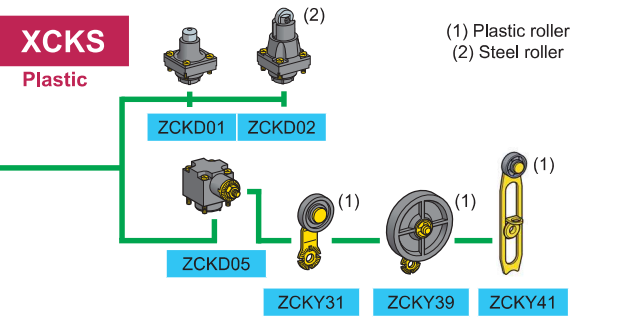

Inductives: XS Range

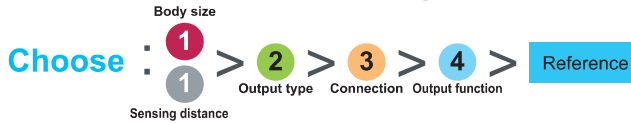

			M8		M12	
Sensing distance			1.5 mm	2.5 mm	2 mm	4 mm
DC3	PNP	cable	XS508B1P A L2	XS108B3P A L2	XS512B1P A L2	XS112B3P A L2
		connector	XS508B1P A M8	XS108 B3P A M8	XS512B1P A M12	XS112B3P A M12
	NPN	cable	XS508B1N A L2	XS108B3N A L2	XS512B1N A L2	XS112B3N A L2
		connector	XS508B1N A M8	XS108B3N A M8	XS512B1N A M12	XS112B3N A M12
DC2		cable	XS508B3C A L2	XS608B3C A L2	XS512BSD A L2	XS612B3D A L2
		connector	XS508B3C A L01M12	XS608B3C A L01M12	XS512BSD A M12	XS612B3D A M12
DC3	PNP	cable	XS508BLP A L2	XS608B1P A L2	XS512BLP A L2	XS612B1P A L2
		connector	XS508BLP A M12	XS608B1P A M12	XS512BLP A M12	XS612B1P A M12
	NPN	cable	XS508BLN A L2	XS608B1N A L2	XS512BLN A L2	XS612B1N A L2
		connector	XS508BLN A M12	XS608B1N A M12	XS512BLN A M12	XS612B1N A M12
DC2		cable	XS508B1D A L2	XS608B1D A L2	XS512B1D A L2	XS612B1D A L2
		connector	XS508B1D A M12	XS608B1D A M12	XS512B1D A M12	XS612B1D A M12
AC/DC		cable			XS512B1M A L2	XS612B1M A L2
		connector			XS512B1M A U20	XS612B1M A U20
Output function		NO	A	A	A	A
		NC	B	B	B	B
		NO + NC				(short only) C

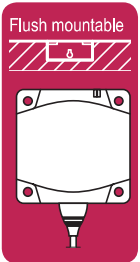
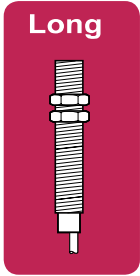

			∅ 8x22x8 mm	∅ 15x32x8 mm	∅ 26x26x13 mm	∅ 40x40x15 mm
Sensing distance			2.5 mm	5 mm	10 mm	15 mm
DC3	PNP	cable	XS7J1A1P A L2	XS7F1A1P A L2	XS7E1A1P A L2	XS7C1A1P A L2
		connector	XS7J1A1P A L01M8	XS7F1A1P A L01M8	XS7E1A1P A M8	XS7C1A1P A M8
	NPN	cable	XS7J1A1N A L2	XS7F1A1N A L2	XS7E1A1N A L2	XS7C1A1N A L2
		connector	XS7J1A1N A L01M8	XS7F1A1N A L01M8	XS7E1A1N A M8	XS7C1A1N A M8
DC2		cable	XS7J1A1D A L2	XS7F1A1D A L2	XS7E1A1D A L2	XS7C1A1D A L2
		connector	XS7J1A1D A L01M8	XS7F1A1D A L01M8	XS7E1A1D A M8	XS7C1A1D A M8

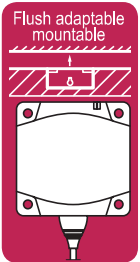

			∅ 26x26x13 mm		∅ 40x40x15 mm	
Sensing distance			15 mm	25 mm		
DC3	PNP	cable	XS8E1A1P A L2	XS8C1A1P A L2		
		connector	XS8E1A1P A M8	XS8C1A1P A M8		
	NPN	cable	XS8E1A1N A L2	XS8C1A1N A L2		
		connector	XS8E1A1N A M8	XS8C1A1N A M8		
AC/DC		cable	XS8E1A1M A L2	XS8C1A1M A L2		
		connector	XS8E1A1M A L01U20	XS8C1A1M A L01U20		
Output function		NO	A	A	A	A
		NC	B	B	B	B



4
1 3

XS.....M8:
Connector M8 3 pin

4
1 2 3

XS.....M12:
Connector M12 4 pin

1
2 3

XS.....U20:
Connector 1/2" 3 pin

Cabling XS

		PUR pre wired connectors (female)*	
M8		straight	elbowed
3 pin	2 m	XZCP0566L2	XZCP0666L2
	5 m	XZCP0566L5	XZCP0666L5
	10 m	XZCP0566L10	XZCP0666L10
1/2"	3 pin	XZCP1865L5	XZCP1965L5

*For a PVC cable, add the letter V after the P. Example: XZCPxxxxx become XZCPVxxxxx

Inductives: XS Range

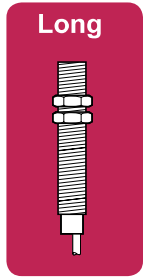

			M18		M30	
Sensing distance			5 mm	8 mm	10 mm	15 mm
DC3	PNP	cable	XS518B1P A L2	XS118B3P A L2	XS530B1P A L2	XS130B3P A L2
		connector	XS518B1P A M12	XS118B3P A M12	XS530B1P A M12	XS130B3P A M12
	NPN	cable	XS518B1N A L2	XS118B3N A L2	XS530B1N A L2	XS130B3N A L2
		connector	XS518B1N A M12	XS118B3N A M12	XS530B1N A M12	XS130B3N A M12
DC2	cable	XS518BSD A L2	XS618B3D A L2	XS530BSD A L2	XS630B3D A L2	
	connector	XS518BSD A M12	XS618B3D A M12	XS530BSD A M12	XS630B3D A M12	
DC3	PNP	cable	XS518BLP A L2	XS618B1P A L2	XS530BLP A L2	XS630B1P A L2
		connector	XS518BLP A M12	XS618B1P A M12	XS530BLP A M12	XS630B1P A M12
	NPN	cable	XS518BLN A L2	XS618B1N A L2	XS530BLN A L2	XS630B1N A L2
		connector	XS518BLN A M12	XS618B1N A M12	XS530BLN A M12	XS630B1N A M12
DC2	cable	XS518B1D A L2	XS618B1D A L2	XS530B1D A L2	XS630B1D A L2	
	connector	XS518B1D A M12	XS618B1D A M12	XS530B1D A M12	XS630B1D A M12	
AC/DC	cable	XS518B1M A L2	XS618B1M A L2	XS530B1M A L2	XS630B1M A L2	
	connector	XS518B1M A U20	XS618B1M A U20	XS530B1M A U20	XS630B1M A U20	
Output function	NO		A	A	A	A
	NC		B	B	B	B
	NO + NC		(short only) C		(short only) C	

Accessories

M8	XSZB108
M12	XSZB112
M18	XSZB118
M30	XSZB130



Screw terminal M 20



Connector M 12, 4 pin

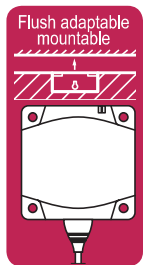
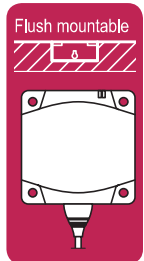

			80x80x26 mm	
Sensing distance			40 mm	
DC3	PNP	cable	XS7D1A1P A L2	
		connector	XS7D1A1P A M12	
	NPN	cable	XS7D1A1N A L2	
		connector	XS7D1A1N A M12	
DC2	cable	XS7D1A1D A L2		
	connector	XS7D1A1D A M12		
Sensing distance			60 mm	
DC3	PNP	cable	XS8D1A1P A L2	
		connector	XS8D1A1P A M12	
	NPN	cable	XS8D1A1N A L2	
		connector	XS8D1A1N A M12	
AC/DC	cable	XS8D1A1M A L2		
	connector	XS8D1A1M A U20		
Output function	NO		A	
	NC		B	

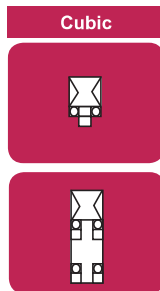

		40x40x117 mm		20 mm	40 mm
DC4	PNP	NO+NC	XS8C2A1PCM12	XS8C2A4PCM12	
	NPN	NO+NC	XS8C2A1NCM12	XS8C2A4NCM12	
DC2		NO	XS8C2A1DAM12	XS8C2A4DAM12	
AC/DC		NO	XS8C2A1MAU20	XS8C2A4MAU20	
DC4	PNP	NO+NC	XS8C4A1PC P20	XS8C4A4PC P20	
	NPN	NO+NC	XS8C4A1NC P20	XS8C4A4NC P20	
DC2		NO or NC	XS8C4A1DP P20	XS8C4A4DP P20	
		NO or NC	XS8C4A1MP P20	XS8C4A4MP P20	
Select the type of connection	M20		P20	P20	
	PG13		G13	G13	
	1/2" NPT		N12	N12	

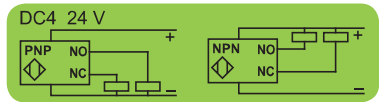
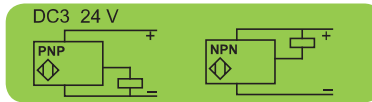

Accessories

For 26x26	XSZBE00	XSZBE90
For 40x40	XSZBC00	XSZBC90

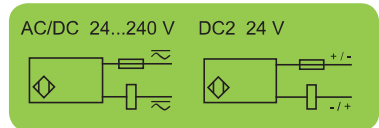

Rotation monitoring: XSAV Range

Choose: **1** > **2** > Reference

Speed Output Type

			Sensing distance		
			10 mm	10 mm	
M30	Flush	cable	Output type		
			DC3-PNP	XSAV11373	XSAV12373
			AC/DC	XSAV11801	XSAV12801

Cabling XS

		PUR pre wired connectors (female)*		
		straight	elbowed	elbowed PNP LED
M12	4 pin	2 m XZCP1141L2	XZCP1241L2	XZCP1340L2
		5 m XZCP1141L5	XZCP1241L5	XZCP1340L5
		10 m XZCP1141L10	XZCP1241L10	XZCP1340L10

		Connectors (female)	
		straight	elbowed
M12	4 pin (1)	XZCC12FDM40B	XZCC12FCM40B
	4 pin (2)	XZCC12FDP40B	XZCC12FCP40B

*For a PVC cable, add the letter V after the P. Example: XZCPxxxxx become XZCPVxxxxx

(1) Steel ring (2) Plastic ring

Ultrasonics: XX Range

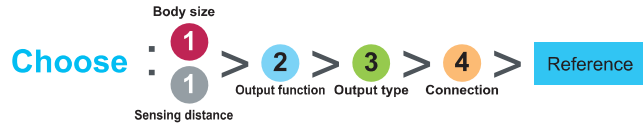

			M12		M18		M18 plastic (2)	M18 brass (2)	M18 stainless (2)	M18 metal	
Sensing distance			0.05 m	0.1 m	0.15 m	0.5 m Adjust. (1)	1 m Adjust. (1)	1 m Adjust. (1)	1 m Adjust. (1)	0.05 m	
Connectors/Cables			M8 4 pin	M8 3 pin	M12 4 pin	M12 4 pin	M12 5 pin	M12 5 pin	M12 5 pin	M12 4 pin	
NO	DC4	PNP/NPN	XX512A1KAM8		XX518A1KAM12						
		DC3		XX512A2PAM8		XX518A3PAM12			XXV18B1PAM12		
				XX512A2NAM8		XX518A3NAM12			XXV18B1NAM12		
NO or NC	DC3	PNP					XX S 18P1PM12	XX S 18B1PM12	XX S 18S1PM12		
							XX A 18P1PM12	XX A 18B1PM12	XX A 18S1PM12		
Analog		4...20 mA			XX918A3C2M12		XX S 18P1AM12	XX S 18B1AM12	XX S 18S1AM12		
							XX A 18P1AM12	XX A 18B1AM12	XX A 18S1AM12		
			0...10 V			XX918A3F1M12		XX S 18P1VM12	XX S 18B1VM12	XX S 18S1VM12	
								XX A 18P1VM12	XX A 18B1VM12	XX A 18S1VM12	

(1) Adjustable with XXZPB100

(2) Configurable with XXZBOX01 by software

S = straight A = angled

			M30 plastic (2)				M30 Brass (2)			M30 Stainless (2)		
Sensing distance			1 m Adjust. (1)	2 m Adjust. (1)	4 m Adjust. (1)	8 m Adjust. (3)	1 m Adjust. (1)	2 m Adjust. (1)	4 m Adjust. (1)	1 m Adjust. (1)	2 m Adjust. (1)	4 m Adjust. (1)
Connectors			M12 5-pin	M12 5-pin	M12 5-pin	M12 5-pin	M12 5-pin	M12 5-pin	M12 5-pin	M12 5-pin	M12 5-pin	M12 5-pin
NO or NC	DC3	PNP	XX S 30P1PM12	XX S 30P2PM12	XXS30P4PM12		XX S 30B1PM12	XX S 30B2PM12	XXS30B4PM12	XX S 30S1PM12	XX S 30S2PM12	XXS30S4PM12
			XX A 30P1PM12	XX A 30P2PM12		XX A 30B1PM12	XX A 30B2PM12		XX A 30S1PM12	XX A 30S2PM12		
	DC4	2 x PNP			XXS30P8PPM12							
		2 x NPN			XXS30P8NNM12							
Analog	DC3	4...20mA	XX S 30P1AM12	XX S 30P2AM12	XXS30P4AM12		XX S 30B1AM12	XX S 30B2AM12	XXS30B4AM12	XX S 30S1AM12	XX S 30S2AM12	XXS30S4AM12
			XX A 30P1AM12	XX A 30P2AM12		XX A 30B1AM12	XX A 30B2AM12		XX A 30S1AM12	XX A 30S2AM12		
		0...10V	XX S 30P1VM12	XX S 30P2VM12	XXS30P4VM12		XX S 30B1VM12	XX S 30B2VM12	XXS30B4VM12	XX S 30S1VM12	XX S 30S2VM12	XXS30S4VM12
			XX A 30P1VM12	XX A 30P2VM12		XX A 30B1VM12	XX A 30B2VM12		XX A 30S1VM12	XX A 30S2VM12		
Analog + NO or NC	DC4	4...20 mA + PNP			XXS30P8APM12							
			0...10V + PNP			XXS30P8VPM12						

(1) Adjustable with XXZPB100

(2) Configurable with XXZBOX01 by software

(3) Push-button integrated on the product S = straight A = angled

			Flat 7.6x19x33		Flat 16x30x74		Flat 60x30x18 + M18	
Sensing distance			0.1 m		0.25 m		0.5 m Adjust.	0.5 m Adjust.
Connectors			M12 4 pin		M12 4 pin		M12 4 pin	M12 4 pin
NO	DC3	PNP	XX7F1A2PAL01M12	XX7K1A2PAM12			XX7V1A1PAM12 (1)	
		NPN	XX7F1A2NAL01M12	XX7K1A2NAM12			XX7V1A1NAM12 (1)	
Analog		4...20 mA					XX9V1A1C2M12 (1)	
		0...10 V					XX9V1A1F1M12 (1)	

(1) Adjustable with XXZPB100

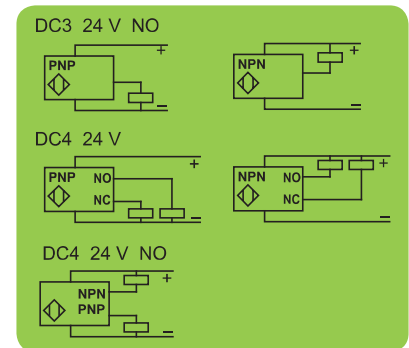

XUZ 2001	M12	XUZB2012
XUZ 2003	M18	XUZB2003
	M30	XUZB2030

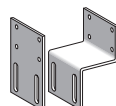

For XX7K
Flat XXZ3074F
Cranked XXZ3074S

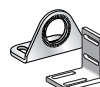

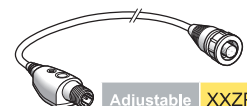

M12	XXZ12
M18	XUZA118
M30	XXZ30
XX7F	XXZ1933

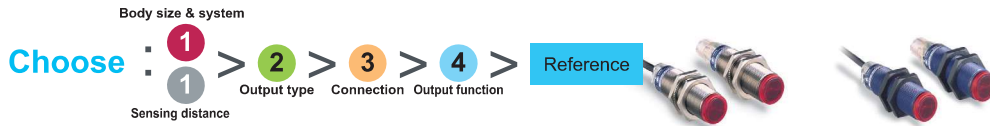

Adjustable XXZPB100

Photo-electrics: XU Range



Sensing distance					M18 metal	M18 plastic
Diffuse 	0.6 m	DC3	PNP	cable	XUB5BP A NL2	XUB5AP A NL2
				connector 4P	XUB5BP A NM12	XUB5AP A NM12
	0.1 m	DC3	PNP	cable	XUB5BN A NL2	XUB5AN A NL2
				connector 4P	XUB5BN A NM12	XUB5AN A NM12
			NPN	cable	XUB4BP A NL2	XUB4AP A NL2
				connector 4P	XUB4BP A NM12	XUB4AP A NM12

Miniature	
1.9 m	XUM5AP X BL2
	XUM5AP X BM8
	XUM5AN X BL2
	XUM5AN X BM8
1.1 m	XUM6AP X BL2
	XUM6AP X BM8
	XUM6AN X BL2
	XUM6AN X BM8
0.25 m	XUM4AP X BL2
	XUM4AP X BM8
	XUM4AN X BL2
	XUM4AN X BM8
0.3 m	XUM8AP X BL2
	XUM8AP X BM8
	XUM8AN X BL2
	XUM8AN X BM8

Background Suppression

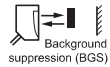

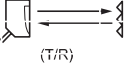
Polarized Reflex	2 m	DC3	PNP	cable	XUB9BP A NL2	XUB9AP A NL2			
			NPN	cable	XUB9BP A NM12	XUB9AP A NM12			
				connector 4P	XUB9BN A NL2	XUB9AN A NL2			
			Accessory: Reflector				cable	XUB9BN A NM12	XUB9AN A NM12
							connector 4P	XUZC50	XUZC50

8 m	XUM9AP X BL2					
	XUM9AP X BM8					
	XUM9AN X BL2					
	XUM9AN X BM8					
					XUZC50	XUZC50

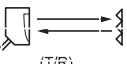
Reflex	4 m	DC3	PNP	cable	XUB1BP A NL2	XUB1AP A NL2			
			NPN	cable	XUB1BP A NM12	XUB1AP A NM12			
				connector 4P	XUB1BN A NL2	XUB1AN A NL2			
			Accessory: Reflector				cable	XUB1BN A NM12	XUB1AN A NM12
							connector 4P	XUZC50	XUZC50

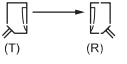
Thru-beam	15 m	DC3	PNP	cable	XUB2BP A NL2R	XUB2AP A NL2R			
			NPN	connector 4P	XUB2BP A NM12R	XUB2AP A NM12R			
				cable	XUB2BN A NL2R	XUB2AN A NL2R			
			Transmitter				connector 4P	XUB2BN A NM12R	XUB2AN A NM12R
							cable	XUB2BKS NL2T	XUB2AKS NL2T
			Output function				connector 4P	XUB2BKSNM12T	XUB2AKSNM12T
							NO	A	A
				NC	B	B			

30 m	XUM2AP X BL2					
	XUM2AP X BM8					
	XUM2AN X BL2					
	XUM2AN X BM8					
					Transmitters are already included	

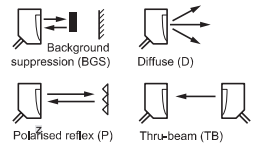
Multimode	DC3	PNP	cable	XUB0BPSNL2	XUB0APSNL2	XUM0APSNL2		
		NPN	connector 4P	XUB0BPSNM12	XUB0APSNM12	XUM0APSAM8		
			cable	XUB0BNSNL2	XUB0ANSNL2	XUM0ANSAL2		
		Sensing distance				Background Sup: 0.12 m	Diffuse: 0.3 m	XUM0ANSAM8
						Output function	NO or NC	Polarized reflex: 3 m
		Transmitter	DC			cable	XUB0AKSNL2T	P: 3 m TB: 10 m
						connector 4P	XUB0BKSNM12T	XUB0AKSNM12T
						XUM0AKSAM8T		



Cabling XU

PUR pre wired connectors (female)*

M8	straight	elbowed
4 pin	2 m XZCP0941L2	XZCP1041L2
	5 m XZCP0941L5	XZCP1041L5
	10 m XZCP0941L10	XZCP1041L10

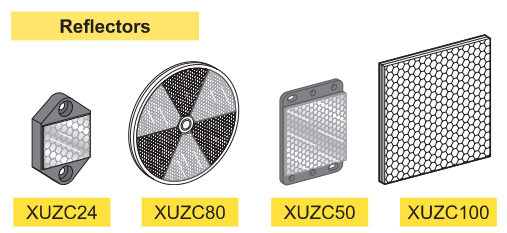

*For a PVC cable, add the letter V after the P. Example: XZCPxxxxx become XZCPVxxxxx

Photo-electrics: XU Range



Sensing distance		Compact 50x50 mm				Compact 92x71 mm				
Diffuse 	1 m	DC3	PNP	cable	XUK5AP A NL2	2.1 m	DC3	PNP	terminals	XUX5AP A NT16
				connector 4P	XUK5AP A NM12				connector 4P	XUX5AP A NM12
		NPN	cable	XUK5AN A NL2	NPN	terminals	XUX5AN A NT16			
			connector 4P	XUK5AN A NM12		connector 4P	XUX5AN A NM12			
		AC/DC	Relay	cable	XUK5ARCNL2	AC/DC	Relay	terminals	XUX5ARCNT16	
		Output function		NO		A		NO		A
		NC		B		NC		B		
Polarized Reflex 	5 m	DC3	PNP	cable	XUK9AP A NL2	11 m	DC3	PNP	terminals	XUX9AP A NT16
				connector 4P	XUK9AP A NM12				connector 4P	XUX9AP A NM12
		NPN	cable	XUK9AN A NL2	NPN	terminals	XUX9AN A NT16			
			connector 4P	XUK9AN A NM12		connector 4P	XUX9AN A NM12			
		AC/DC	Relay	cable	XUK9ARCNL2	AC/DC	Relay	terminals	XUX9ARCNT16	
		Accessory: Reflector		XUZC50		XUZC50				
Reflex 	7 m	DC3	PNP	cable	XUK1AP A NL2	14 m	DC3	PNP	terminals	XUX1AP A NT16
				connector 4P	XUK1AP A NM12				connector 4P	XUX1AP A NM12
		NPN	cable	XUK1AN A NL2	NPN	terminals	XUX1AN A NT16			
			connector 4P	XUK1AN A NM12		connector 4P	XUX1AN A NM12			
		AC/DC	Relay	cable	XUK1ARCNL2	AC/DC	Relay	terminals	XUX1ARCNT16	
		Accessory: Reflector		XUZC50		XUZC50				
Thru-beam 	30 m	DC3	PNP	cable	XUK2AP A NL2R	40 m	DC3	PNP	terminals	XUX2AP A NT16R
				connector 4P	XUK2AP A N M12R				connector 4P	XUX2AP A NM12R
		NPN	cable	XUK2AN A NL2R	NPN	terminals	XUX2AN A NT16R			
			connector 4P	XUK2AN A NM12R		connector 4P	XUX2AN A NM12R			
		AC/DC	Relay	cable	XUK2AKSNL2T	AC/DC	Relay	terminals	XUX0AKSAT16T	
				connector 4P	XUK2AKSNM12T			connector 4P	XUX0AKSAM12T	
Accessory: Transmitter		XUK2ARCNL2R		XUK2ARCNT16R						
		XUK2ARCNL2T		XUX0ARCTT16T						

Multimode		DC3 PNP/NPN		DC3 PNP/NPN			
	Background suppression (BGS) Diffuse (D) Polarized reflex (P) Thru-beam (TB)	cable	XUK0AKSAL2	terminals	XUX0AKSAT16		
		connector 4P	XUK0AKSAM12	connector 4P	XUX0AKSAM12		
		AC/DC	Relay	cable	XUK0ARCTL2	AC/DC	Relay
Background Suppression: 0,28 m		Diffuse: 0,8 m		Background Suppression: 1,3 m			
Polarized reflex: 4 m		Thru-beam: 30 m		Polarized reflex: 11 m			
Thru-beam: 40 m		DC		DC			
Accessory: Transmitter		cable		terminals			
		connector 4P		connector 4P			
		cable		terminals			
		XUK0AKSAL2T		XUX0AKSAT16T			
		XUK0AKSAM12T		XUX0AKSAM12T			
		XUK0ARCTL2T		XUX0ARCTT16T			

Other fixings

Single bracket

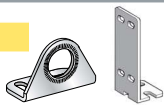

	standard	with ball joint
XUB	XUZA118 (stainless steel)	XUZA218 (plastic)
XUM	XUZA50	-
XUK	XUZA51	-
XUX	XUXZ2000	-

DC3 24 V

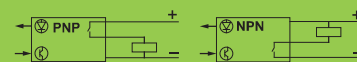

AC/DC Relay 24...240 V

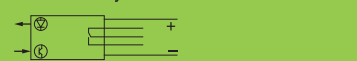

M12	PUR pre wired connectors (female)*			
	straight	elbowed	elbowed PNP LED	
4 pin	2 m	XZCP1141L2	XZCP1241L2	XZCP1340L2
	5 m	XZCP1141L5	XZCP1241L5	XZCP1340L5
	10 m	XZCP1141L10	XZCP1241L10	XZCP1340L10



M12	Connectors (female)	
	straight	elbowed
4 pin (1)	XZCC12FDM40B	XZCC12FCM40B
	4 pin (2)	XZCC12FDP40B

(1) Steel ring (2) Plastic ring

*For a PVC cable, add the letter V after the P. Example: XZCPxxxxx become XZCPVxxxxx

Forks: XUV Range

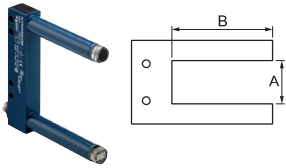

		A: 50 mm / B: 60 mm		A: 80 mm / B: 60 mm		A: 120 mm / B: 120 mm		A: 180 mm / B: 120 mm		
DC3	PNP	M8 3 pin	XUVR0605P	A NM8	XUVR0608P	A NM8	XUVR1212P	A NM8	XUVR1218P	A NM8
	NPN	M8 3 pin	XUVR0605N	A NM8	XUVR0608N	A NM8	XUVR1212N	A NM8	XUVR1218N	A NM8
Output function	NO			A		A		A		A
	NC			B		B		B		B

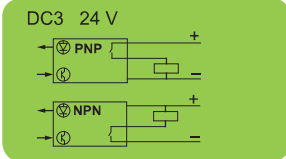

Cabling XX & XUV

		PUR pre wired connectors (female)*			Connectors (female)			
		straight	elbowed	elbowed PNP LED	M12	straight	elbowed	
M8	3 pin	2 m	XZCP0566L2	XZCP0666L2	(1)	4 pin	XZCC12FDM40B	XZCC12FCM40B
		5 m	XZCP0566L5	XZCP0666L5	(2)	4 pin	XZCC12FDP40B	XZCC12FCP40B
		10 m	XZCP0566L10	XZCP0666L10	(1) Steel ring (2) Plastic ring			
4 pin	2 m	XZCP0941L2	XZCP1041L2					
	5 m	XZCP0941L5	XZCP1041L5					
	10 m	XZCP0941L10	XZCP1041L10					
M12	4 pin	2 m	XZCP1141L2	XZCP1241L2	XZCP1340L2	M12	straight	elbowed
		5 m	XZCP1141L5	XZCP1241L5	XZCP1340L5	4 pin	XZCC12MDM40B	XZCC12MCM40B
		10 m	XZCP1141L10	XZCP1241L10	XZCP1340L10	5 pin	XZCC12MDM50B	XZCC12MCM50B

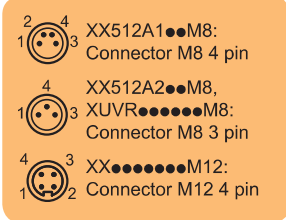

*For a PVC cable, add the letter V after the P. Example: XZCPxxxxx become XZCPVxxxxx

RFID Systems: XG Range



Panel mounting (1)	Compact 40x40mm		
	Sensing distance 18-70mm		
	PNP output with 1 pulse	Modbus RTU	
	Blue body, connector on back	White body with remote lights, connector on back	Stand alone
	XGCS491B201	XGCS49LB201	XGCS490B201

(1) compatible with ZB5AZ905 and XGSCZNFAC

Screw mounting	Compact 40x40mm		Compact 80x80mm	
	Sensing distance 18-70mm		Sensing distance 20-100mm	
	Modbus RTU		Modbus TCP & Ethernet/IP	
	Blue body, connector and cable by side			
	XGCS4901201	XGCS8901201	XGCS850C201	

Accessories	XGSCZNFAC	Set of configuration badges	XZCC12MDB50R	M12 connector
	XGSCZNF01	Configuration badge	XZCPV11V2L2/5/10	M12 pre-wired connector
	XGHB90E341	Pack of user's badges	XZCPV12V2L2/5/10	M12 pre-wired connector
	XGHBPB3345	Key fob tag		

For our complete selection of sensor solutions, visit www.tesensors.com

Schneider Electric Industries SAS

Head Office
35, rue Joseph Monier – CS 30323
F92506 Rueil-Malmaison Cedex
FRANCE

www.tesensors.com

Due to the constant evolution of standards and equipment, the specifications indicated in the text and images of this document can only be guaranteed after confirmation by our departments. Print: Schneider Electric Photos: Schneider Electric

©2021 Schneider Electric. All Rights Reserved. Schneider Electric, OsiSense, and Telemecanique are trademarks and the property of Schneider Electric SE, its subsidiaries and affiliated companies. All other trademarks are the property of their respective owners.

September 2021 9006BR1305 R09/21