

Ceramic Sandwich, Single-In-Line Thin Film Resistor, Through Hole Network (Low Profile 0.20 Custom)

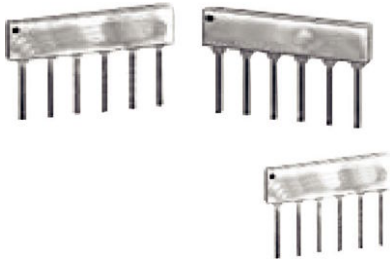

Actual Size

Vishay Dale Thin Film presents a design concept in precision thin film resistor networks. The essence of this new concept is the marriage of two principle design elements . . . a unique resistive film, having electrical properties comparable to those of wire-wound resistors, and a rugged, low cost, ceramic package and an almost limitless variety of sizes and configurations.

SCHEMATIC

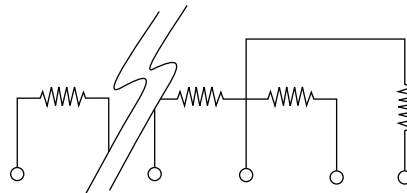

Custom schematics available.
Please consult factory.

FEATURES

- Gold-to-gold terminations. External leads are attached directly to gold pads on the ceramic substrate by thermo-compression bonding (no internal solder)
- Low profile (0.200 min.)
- Custom pin-outs available
- Compliant to RoHS Directive 2002/95/EC
- Halogen-free according to IEC 61249-2-21 definition



RoHS*
COMPLIANT
HALOGEN
FREE

Note

* Pb containing terminations are not RoHS compliant, exemptions may apply

TYPICAL PERFORMANCE

▲	ABSOLUTE	TRACKING
	TCR	25
TOL.	ABSOLUTE	RATIO
	0.05	0.01

STANDARD ELECTRICAL SPECIFICATIONS			
TEST	SPECIFICATIONS		CONDITIONS
Material	Passivated nichrome	Tantalum nitride	-
Pin/Lead Number	3 to 10		-
Resistance Range	20 Ω to 2000 kΩ (total)	20 Ω to 500 kΩ (total)	-
TCR: Absolute	± 10 ppm/°C to ± 25 ppm/°C	± 50 ppm/°C to ± 100 ppm/°C	- 55 °C to + 125 °C
TCR: Tracking	± 2 ppm/°C	± 5 ppm/°C	- 55 °C to + 125 °C
Tolerance: Absolute	± 0.05 % to ± 1.0 %		+ 25 °C
Tolerance: Ratio	± 0.01 % to ± 0.5 %	± 0.02 % to ± 0.5 %	+ 25 °C
Power Rating: Resistor	100 mW (per element)		Typical at + 25 °C
Power Rating: Package	-		-
Stability: Absolute	ΔR ± 0.05 %	ΔR ± 0.1 %	2000 h at + 70 °C
Stability: Ratio	ΔR ± 0.015 %	ΔR ± 0.02 %	2000 h at + 70 °C
Voltage Coefficient	< 0.1 ppm/V	< 0.1 ppm/V	-
Working Voltage	100 V		-
Operating Temperature Range	- 55 °C to + 125 °C		-
Storage Temperature Range	- 55 °C to + 150 °C		-
Noise	< - 30 dB		-
Thermal EMF	< 0.08 μV/°C		-
Shelf Life Stability: Absolute	ΔR ± 0.01 %		1 year at + 25 °C
Shelf Life Stability: Ratio	ΔR ± 0.002 %		1 year at + 25 °C

DIMENSIONS AND IMPRINTING in inches and millimeters			
	DIMENSION	INCHES	MILLIMETERS
	A	0.100 typ. ⁽¹⁾	2.54 typ.
	B	0.020 ± 0.002 typ.	0.51 ± 0.05 typ.
	C	0.125 min.	3.17 min.
	D	0.100 max.	2.54 max.
	E	0.010	0.25
	L (3 Pins)	0.320	8.13
	L (4 Pins)	0.420	10.67
	L (5 Pins)	0.520	13.21
	L (6 Pins)	0.620	15.75
	L (7 Pins)	0.720	18.25
L (8 Pins)	0.820	20.83	
L (9 Pins)	0.920	23.37	
L (10 Pins)	1.020	25.91	
H (3 Pins)	0.200 ⁽²⁾	7.11 ⁽²⁾	
H (4 Pins)			
H (5 Pins)			
H (6 Pins)			
H (7 Pins)			
H (8 Pins)			
H (9 Pins)			
H (10 Pins)			

Notes
⁽¹⁾ Non-accum.

⁽²⁾ Resistance value and schematic dependent. By occupying more than one 0.100 inch square, higher values are available.

MECHANICAL SPECIFICATIONS	
Resistive Element	Passivated nichrome or tantalum nitride
Substrate Material	Alumina
Body	Ceramic
Terminals	Copper alloy
Plating	Gold
Tin/Lead Option	Sn63
Lead (Pb)-free Option	Sn96.5, Ag3.0, Cu0.5
Tin/Lead and Lead (Pb)-free Finish	Hot solder dip

ORDERING INFORMATION CHECK LIST	
Special requirements should be identified in advance, but as a minimum, you should have the following information ready.	
ELECTRICAL	MECHANICAL
1. Resistors, by value and tolerance 2. Reference resistor(s) and matching of which resistors to which reference resistors 3. Resistance by ratio 4. Absolute temperature coefficient of resistivity 5. Temperature tracking of subordinate resistors to reference resistor(s) 6. Maximum operating voltage 7. Resistor power ratings 8. Operating temperature range	1. Maximum allowable seated height (from PC board to top of network) 2. Special marking concerns 3. Schematic pin out of package 4. Specify if lead (Pb)-free
For additional assistance refer to Vishay Dale Thin Film's guide to understanding Thin Film precision. Resistor networks or application engineering. All standard products may be ordered directly from Vishay Dale Thin Film.	



GLOBAL PART NUMBER INFORMATION

New Global Part Numbering: CS1xx-xxxBX

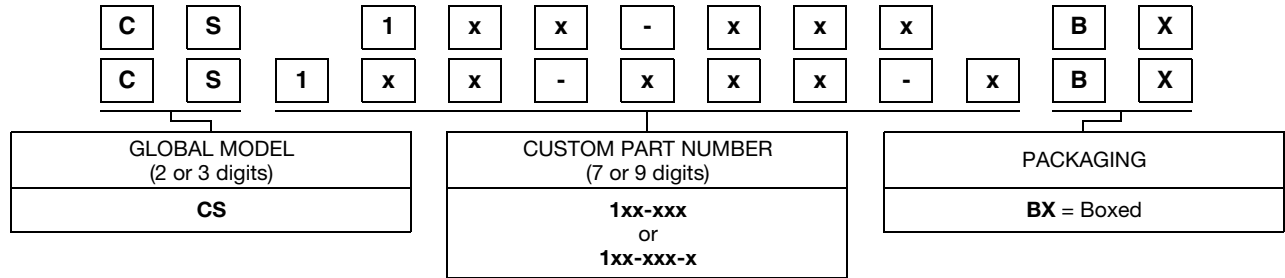

Historical Part Number example: 1xx-xxx (for reference purposes only)

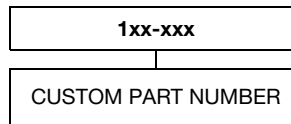



Vishay Dale Thin Film Land Patterns

1. Scope

This technical note provides sample land patterns for Vishay Dale Thin Film SMT resistive products. The following drawings are based on IPC-SM-782 Surface Mount Design and Land Pattern Standard. These drawings are for reference only Vishay Thin Film recommends that the user contacts their PC board supplier for actual land patterns required. The pads are intended for lead (Pb)-free and tin / lead solder types.

2. Product Series

Thin Film Surface Mount Chip Resistors (L, P, PTN, PLT, PLTT, PAT, PATT, PNM, M/D55342 QPL Series)

0402 Land Pattern

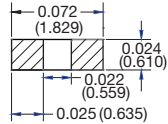

0502 Land Pattern

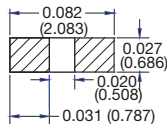

0505 Land Pattern

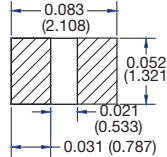

0603 Land Pattern

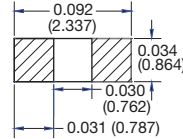

0705 Land Pattern

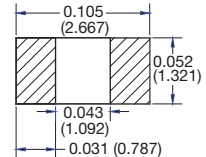

1005 Land Pattern

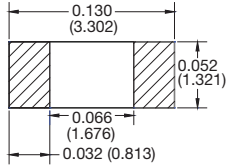

1010 Land Pattern

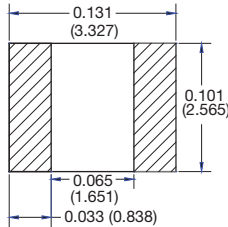

1206 Land Pattern

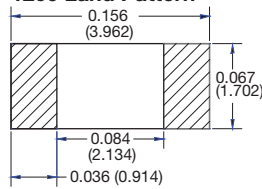

1505 Land Pattern

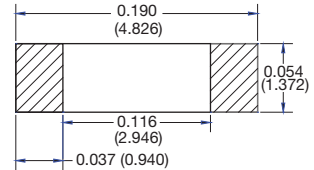

2010 Land Pattern

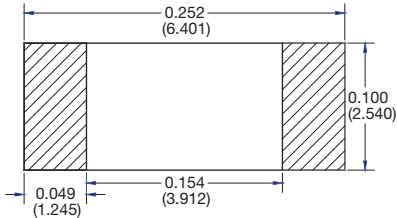

2208 Land Pattern

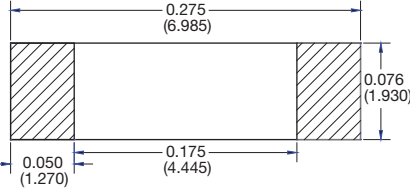

2512 Land Pattern

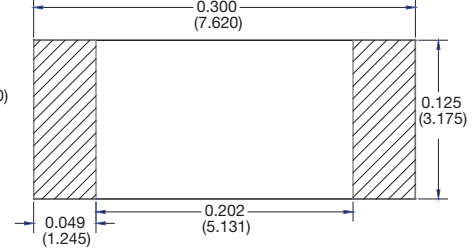



Thin Film Surface Mount Chip Resistors (PHP, PCAN Series)

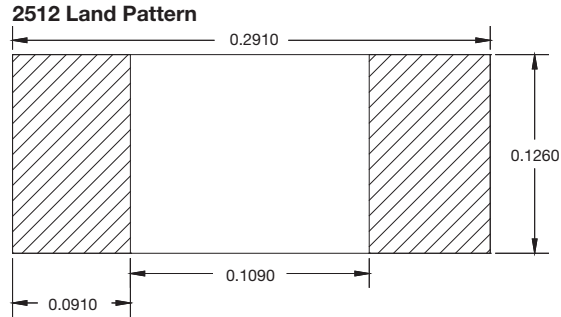
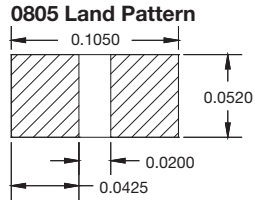
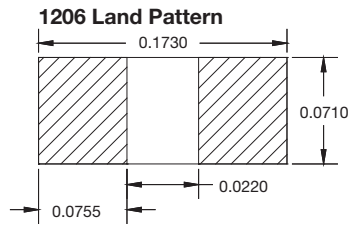
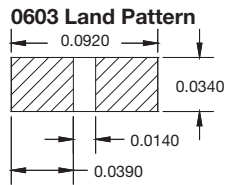

Thin Film Surface Mount Chip Resistors Long Axis Termination (L Series)

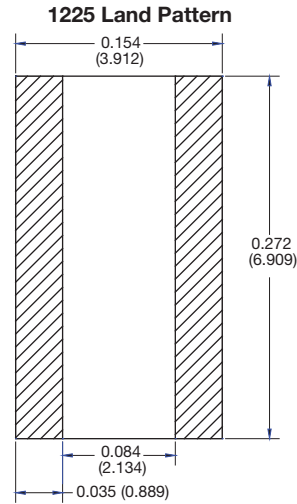
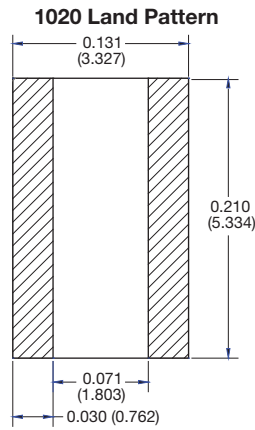
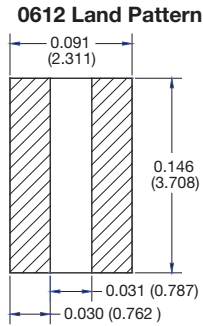
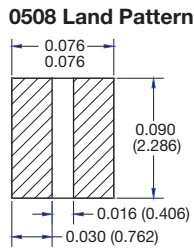



Surface Mount Networks (MPM, MPD, MP3, MP4 Series)

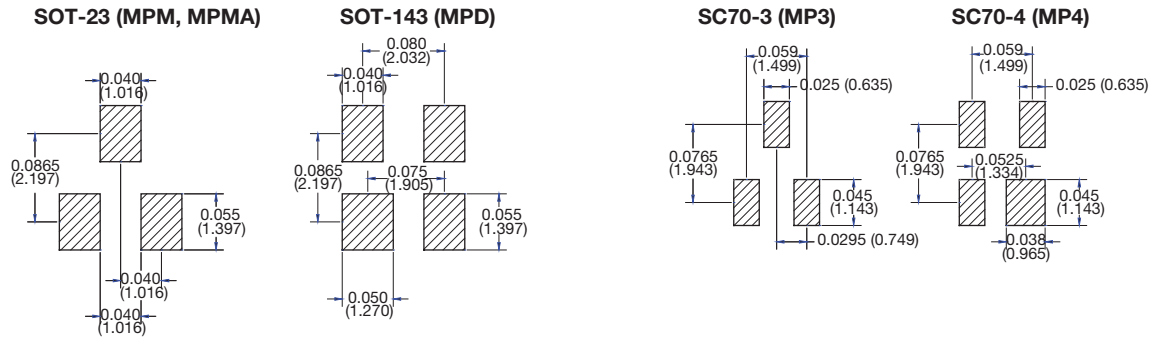

Surface Mount Networks SOIC Narrow Body 150 mils (ORN, CSO, MOMC, HTRN, AORN, MORN Series)

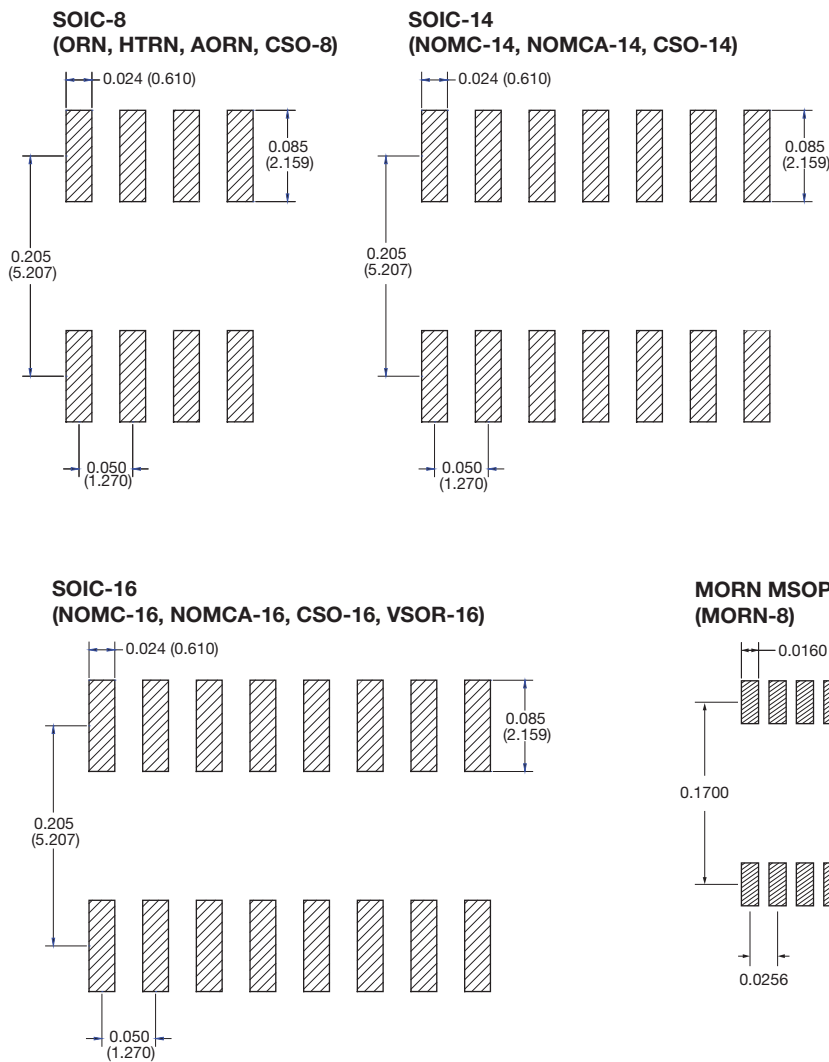



Surface Mount Networks SOIC Medium Body 220 mils (TOMC Series)

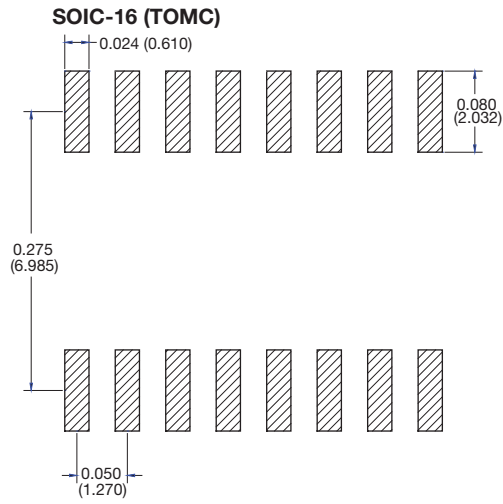

Surface Mount Networks SOIC Wide Body 300 mils (WOMC Series)

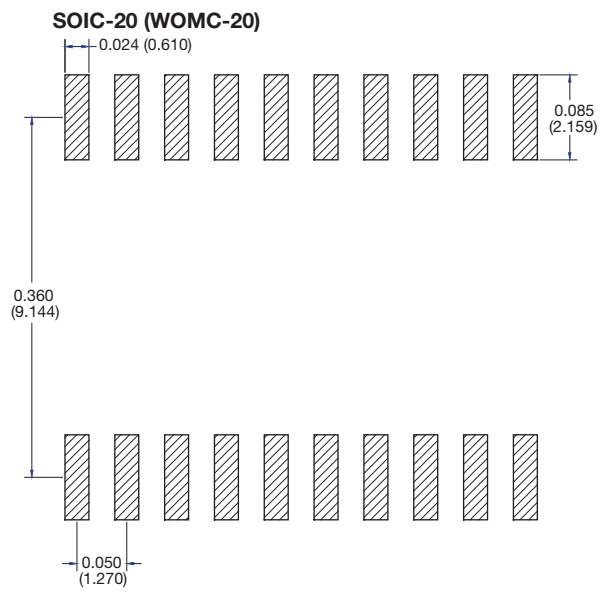
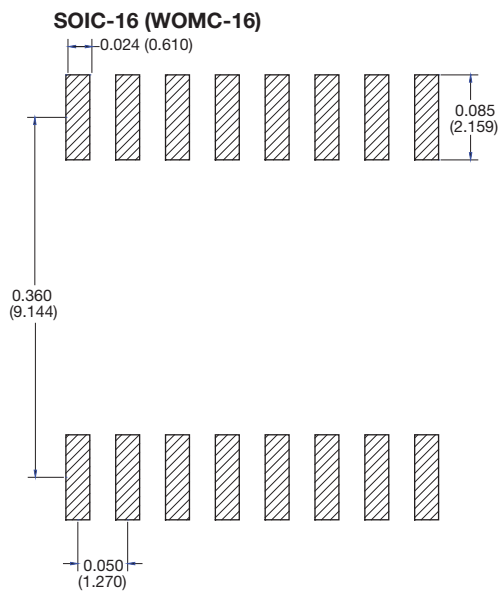



Surface Mount Networks High Density SSOP, TSOP (VSSR, VTSR Series)

SSOP MO-137

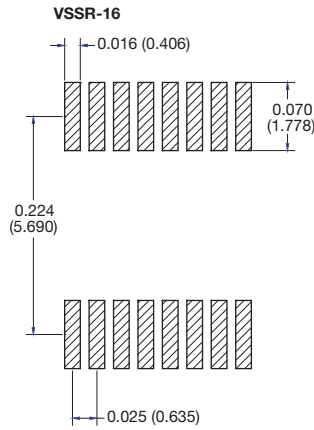

OSOP-20, VSSR-20

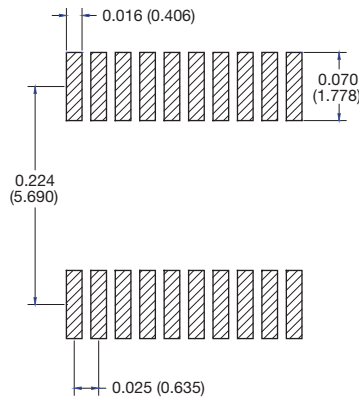

VSSR-24, HD-CSO-24

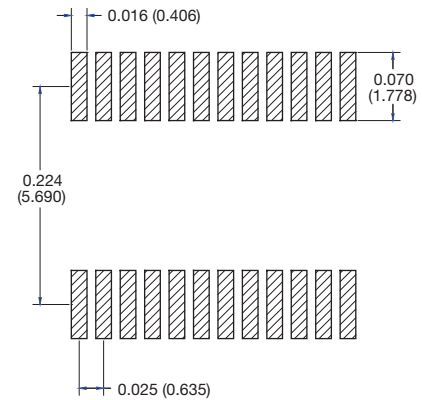

TSSOP MO-153

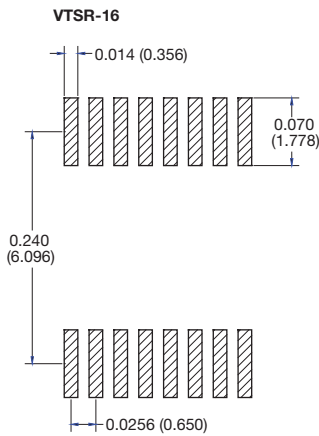

VTSR-20

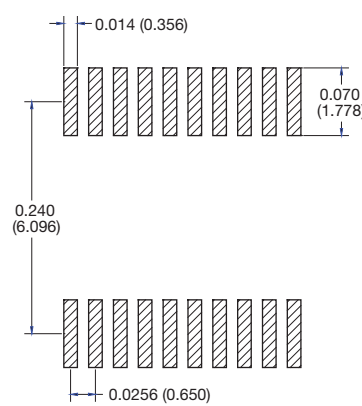

VTSR-24

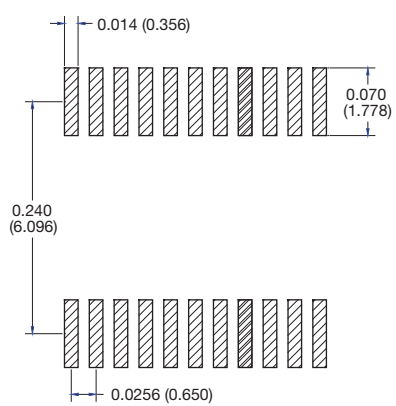

Surface Mount Leadless Networks (LCC Series)

16 Pin LCC

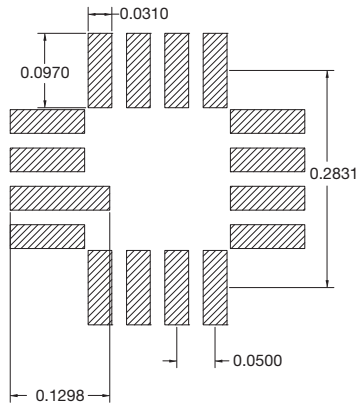

20 Pin LCC

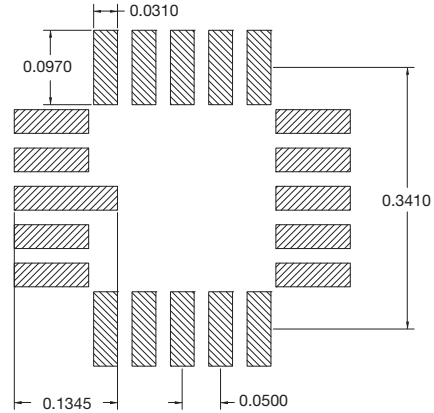

Surface Mount Leadless Networks (MPH Series)

4 Pin LCC

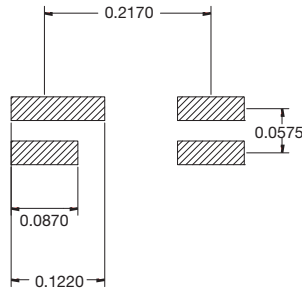

Surface Mount Leadless Packages DUAL/ QUAD Flat No Lead (DFN, QFN Series)

DFN MLP

DFN-8 4 x 5 mm Sq

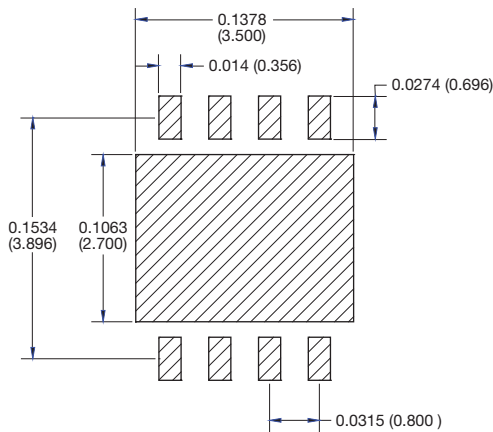

QFN MLP

QFN-20 5 x 5 mm Sq

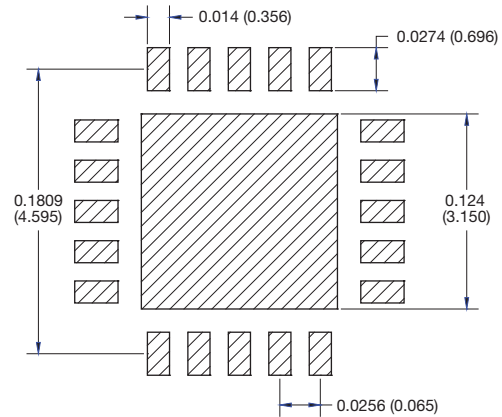



Surface Mount Leadless Resistor Arrays (PR Series)

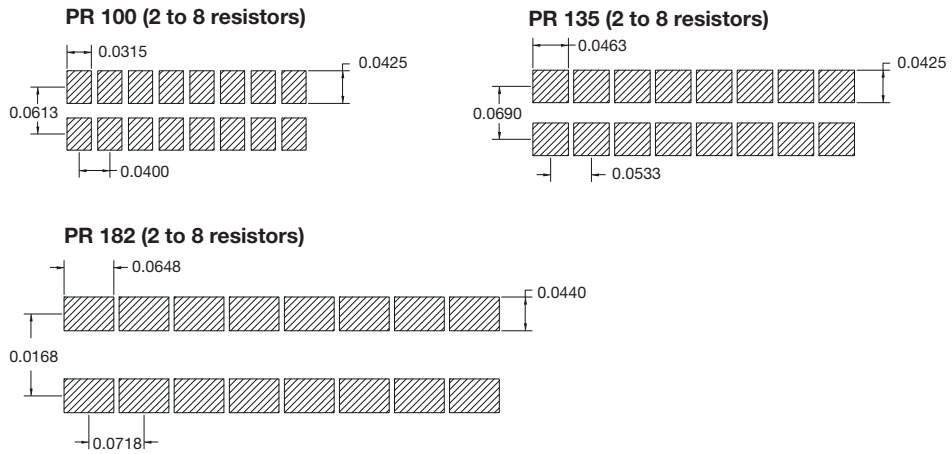

Note

- All dimensions in inches (mm)

Flatpack

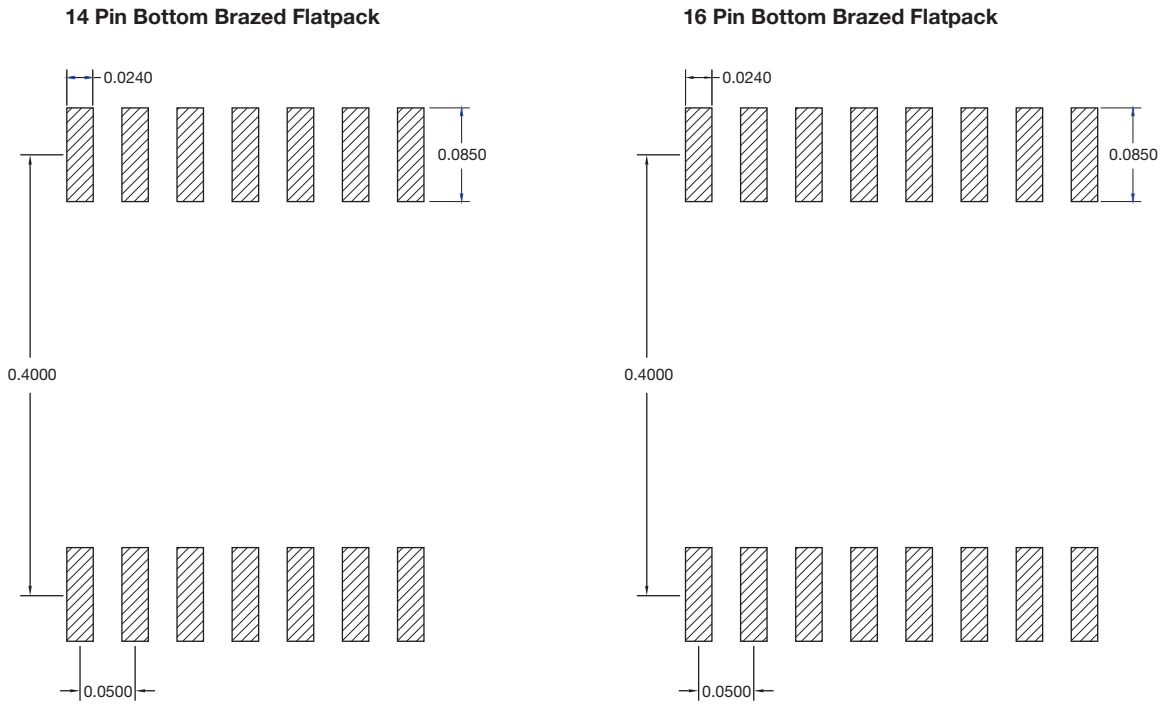



Disclaimer

ALL PRODUCT, PRODUCT SPECIFICATIONS AND DATA ARE SUBJECT TO CHANGE WITHOUT NOTICE TO IMPROVE RELIABILITY, FUNCTION OR DESIGN OR OTHERWISE.

Vishay Intertechnology, Inc., its affiliates, agents, and employees, and all persons acting on its or their behalf (collectively, "Vishay"), disclaim any and all liability for any errors, inaccuracies or incompleteness contained in any datasheet or in any other disclosure relating to any product.

Vishay makes no warranty, representation or guarantee regarding the suitability of the products for any particular purpose or the continuing production of any product. To the maximum extent permitted by applicable law, Vishay disclaims (i) any and all liability arising out of the application or use of any product, (ii) any and all liability, including without limitation special, consequential or incidental damages, and (iii) any and all implied warranties, including warranties of fitness for particular purpose, non-infringement and merchantability.

Statements regarding the suitability of products for certain types of applications are based on Vishay's knowledge of typical requirements that are often placed on Vishay products in generic applications. Such statements are not binding statements about the suitability of products for a particular application. It is the customer's responsibility to validate that a particular product with the properties described in the product specification is suitable for use in a particular application. Parameters provided in datasheets and/or specifications may vary in different applications and performance may vary over time. All operating parameters, including typical parameters, must be validated for each customer application by the customer's technical experts. Product specifications do not expand or otherwise modify Vishay's terms and conditions of purchase, including but not limited to the warranty expressed therein.

Except as expressly indicated in writing, Vishay products are not designed for use in medical, life-saving, or life-sustaining applications or for any other application in which the failure of the Vishay product could result in personal injury or death. Customers using or selling Vishay products not expressly indicated for use in such applications do so at their own risk. Please contact authorized Vishay personnel to obtain written terms and conditions regarding products designed for such applications.

No license, express or implied, by estoppel or otherwise, to any intellectual property rights is granted by this document or by any conduct of Vishay. Product names and markings noted herein may be trademarks of their respective owners.

Material Category Policy

Vishay Intertechnology, Inc. hereby certifies that all its products that are identified as RoHS-Compliant fulfill the definitions and restrictions defined under Directive 2011/65/EU of The European Parliament and of the Council of June 8, 2011 on the restriction of the use of certain hazardous substances in electrical and electronic equipment (EEE) - recast, unless otherwise specified as non-compliant.

Please note that some Vishay documentation may still make reference to RoHS Directive 2002/95/EC. We confirm that all the products identified as being compliant to Directive 2002/95/EC conform to Directive 2011/65/EU.

Vishay Intertechnology, Inc. hereby certifies that all its products that are identified as Halogen-Free follow Halogen-Free requirements as per JEDEC JS709A standards. Please note that some Vishay documentation may still make reference to the IEC 61249-2-21 definition. We confirm that all the products identified as being compliant to IEC 61249-2-21 conform to JEDEC JS709A standards.