

△ OBSOLETE

NOTE: BLOCK MARKING AND CAVITY NUMBERS PRINTED IN GREEN COLOR.

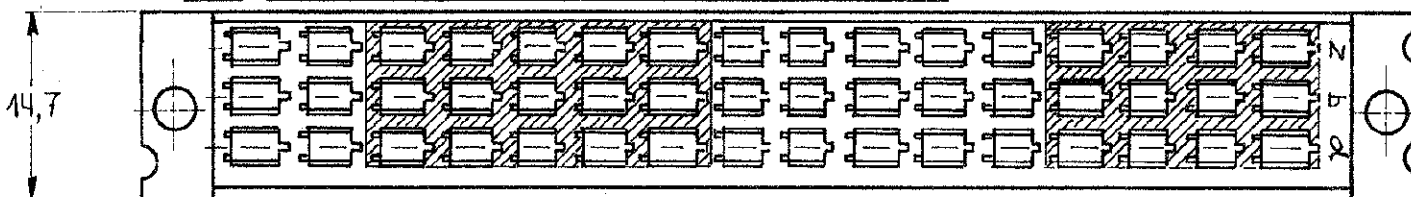

STYLE 3 FURTHER EQUAL TO 1.

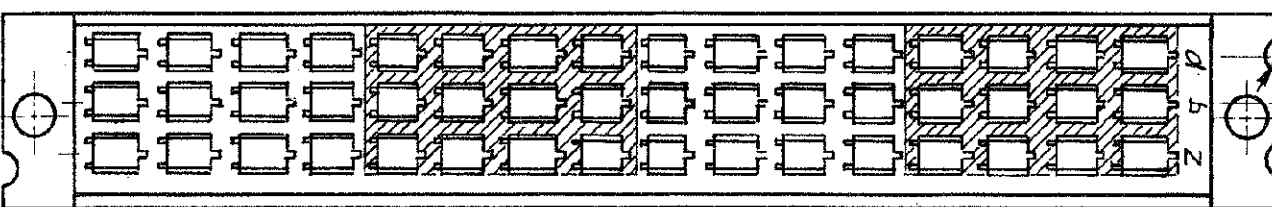

STYLE 2.

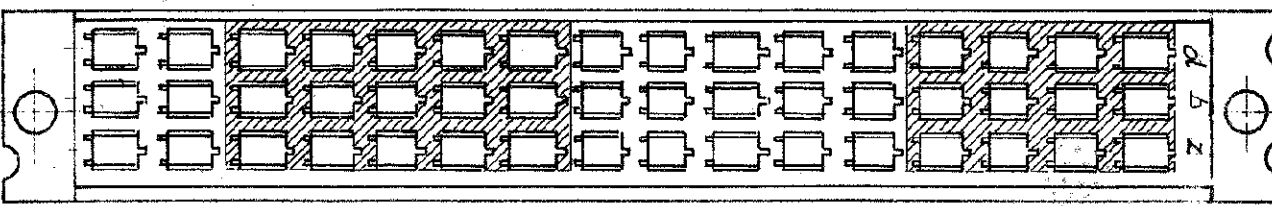

STYLE 1

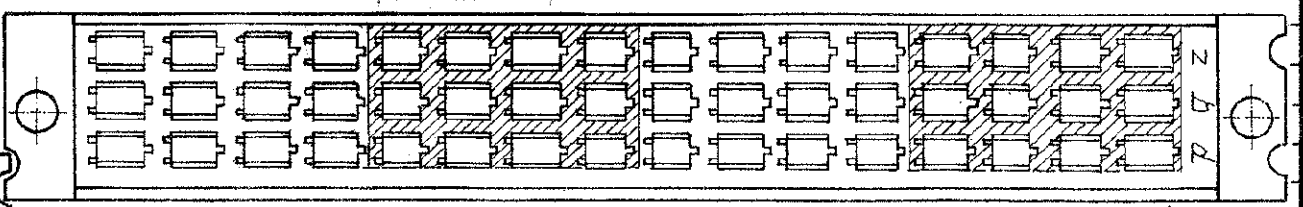

STYLE 4

△	166569-9	20% GLASS FILLED NORYL	GREY RAL 7032	4
△	166569-8	20% GLASS FILLED NORYL	GREY RAL 7032	3
△	166569-7	20% GLASS FILLED NORYL	GREY RAL 7032	1
	166569-1	20% GLASS FILLED NORYL	GREY RAL 7032	2
	ORDER NO.	MATERIAL	COLOR	STYLE

NUMBER 166569

CUSTOMER COPY FOR REFERENCE ONLY

DR L VAN DER HEYDEN 29.09.80 DATE 8.10.80

©1980 BY AMP-HOLLAND N.V. ALL RIGHTS RESERVED A-MP PRODUCTS COVERED BY PATENTS AND/OR PATENTS PENDING.

tyco

Electronics

WIRE-RANGE INSUL-RANGE FIRST USED

SCALE 2:1 SIZE B NO C 166569 SHEET 1 OF 2 REV G

APP DATE 8.10.80 NAME HOUSING, 48 POS., MIDI IEC CONNECTOR FOR CRIMP/SNAP-IN TAB RECEPTACLES (FEM.)

DIMENSIONS IN M.M. - DO NOT SCALE PRINT

DO NOT SCALE

DIMENSIONS IN mm

METRIC

THIRD ANGLE PROJECTION

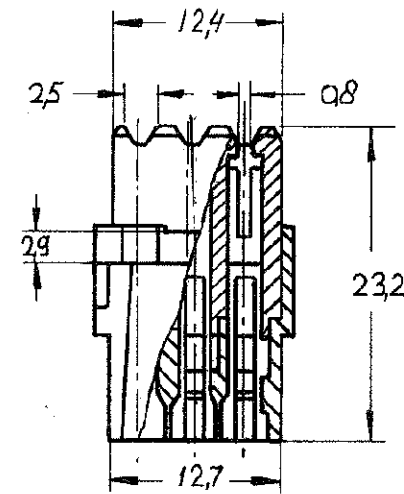
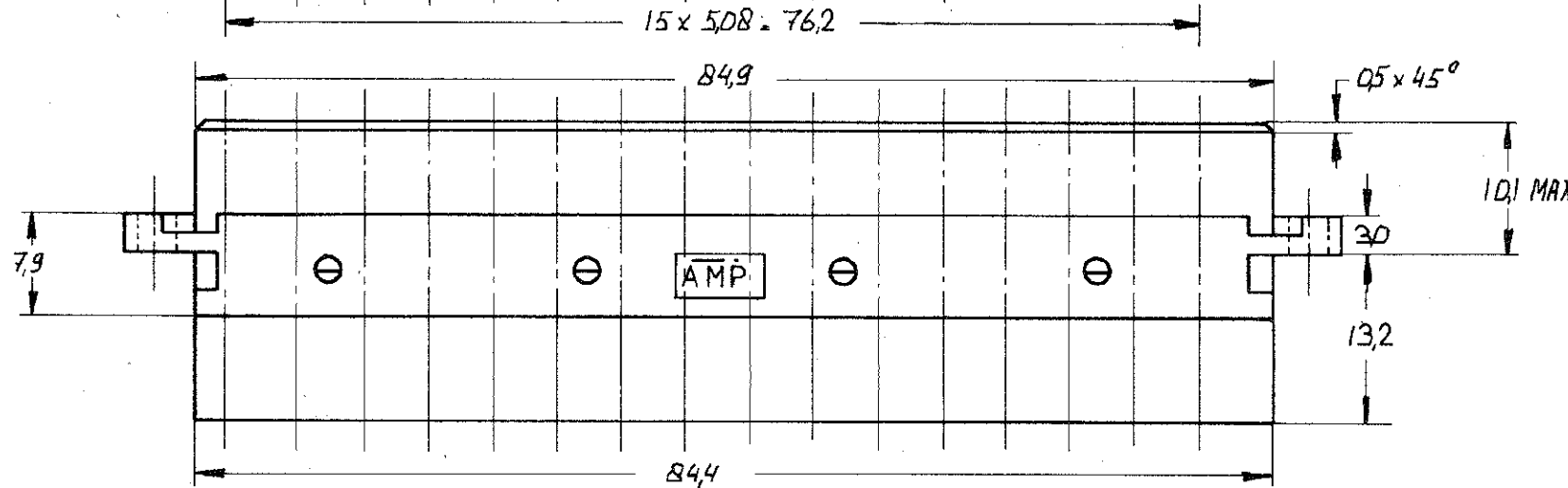
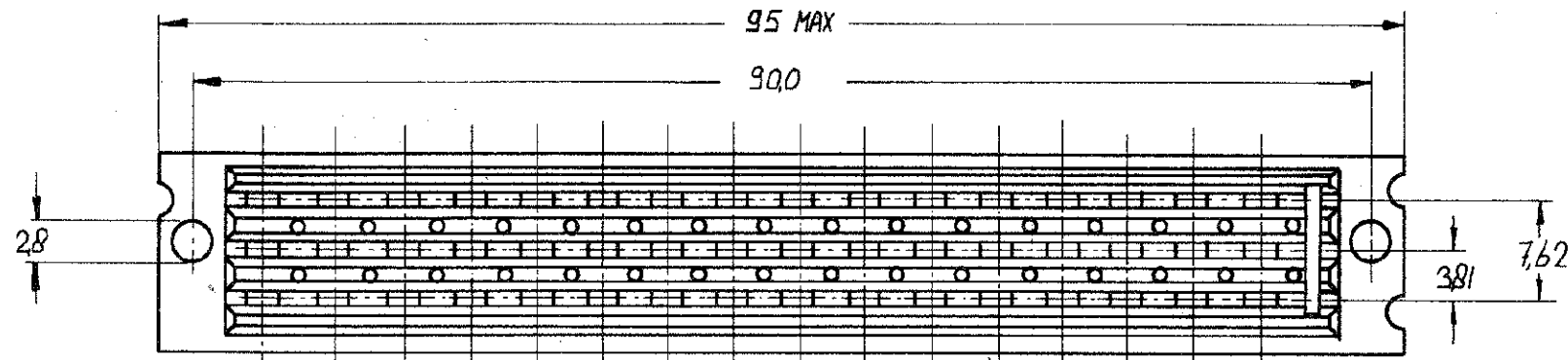
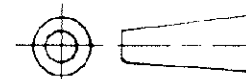

NOTE: 1: BLOCK MARKING AND CAVITY NUMBERS PRINTED IN GREEN COLOR.

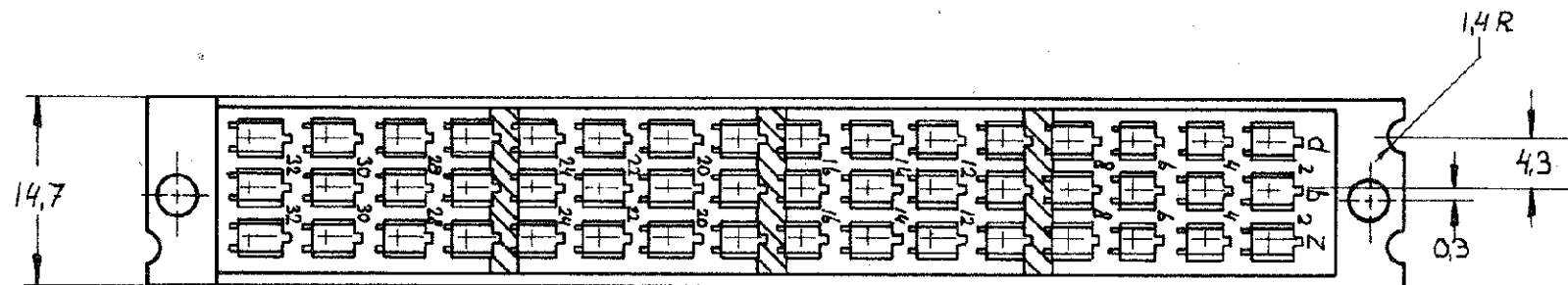

GREY RAL 7032	GLASSFILLED NORYL 20%	1.166569.0
COLOR	MATERIAL	PART NUMBER

CUSTOMER DRAWING
FOR REFERENCE ONLY
WILL NOT BE UPDATED

tyco / Electronics

THIS DRAWING IS UNPUBLISHED | RELEASED FOR PUBLICATION

© COPYRIGHT 19 BY AMP-HOLLAND B.V.
ALL INTERNATIONAL RIGHTS RESERVED.
AMP PRODUCTS MAY BE COVERED BY U.S. AND FOREIGN PATENTS AND/OR PATENTS PENDING.

DR. M.VAES 19.1.83
CHK. [Signature] 20-1-83
APP.

WIRE RANGE	NAME	REV. DATE
INSUL RANGE	48 POS FEMALE HOUSING TYPE F FOR CRIMP/SNAP IN CONTACT	D M Y
SIZE A3	SHEET 2 OF 2	16 10 03
DRAWING NO. C 166569	REV. LTR G	

8 7 6 5 4 3 2 1