

COMPACT DESIGN



JHT Z-Axis

JHT Z-Axis with Pushbuttons

The JHT Z-Axis Miniature Series Hall Effect Joystick allows for a 60° rotational movement of the knob at the top of the joystick. Z-Axis options include detent, friction hold or spring return to center. Its compact design is the ideal solution where space is limited and precision control is required, while its robust construction is suited for demanding applications. The JHT joystick has been tested to five million cycles in all directions with no degradation of performance. The Z-Axis and/or pushbuttons have been tested to one million cycles. Various gating options are also available. The JHT Z-Axis electronics are sealed to IP68S and can withstand EMI/RFI per SAE J1113 specifications. The JHT Z-Axis has numerous applications and is ideal for construction equipment, unmanned vehicles, hydraulic controls, industrial vehicle controls, medical and surgery equipment and surveillance video cameras.

Features:

- 60° rotational movement of the knob
- Compact design
- Contactless analog output Hall effect technology
- 5 million operational cycles in all directions (Joystick)
- Joystick electronics sealed per IP68S
- Optional pushbutton switches available
- RoHS/WEEE/Reach compliant

Standard Characteristics/Ratings:				
GENERAL:				
Sensor Type:	Hall effect analog, factory programmed ground and supply line break detection; over voltage and reverse voltage protection			
Design:	Contactless sensing			
ELECTRICAL RATINGS: Rated at Vcc = 5V @ 20°C Load = 1ma (4.7KΩ)				
Electrical - Joystick Z-Axis Return to Center				
	Units	Min	Typ	Max
Supply Voltage	VDC	4.5	5	5.5
Output 1+2 Voltage, +Z, -Z 0° Deflection	VDC @ 5V Vcc	2.25	2.50	2.75
Output 1+2 at Full Travel +Z Direction	VDC @ 5V Vcc	4.25	4.50	4.55
Output 1+2 at Full Travel -Z Direction	VDC @ 5V Vcc	0.45	0.50	0.75
Supply current (per sensor) B = 0, Vcc = 5V, Io = 0	mA	N/A	N/A	10.0
Output - Source Current Limit B = -X, Vo = 0	mA	-1.0	N/A	1.0
Electrical - Joystick Z-Axis Friction				
	Units	Min	Typ	Max
Supply Voltage	VDC	4.5	5	5.5
Output 1+2 at Full Travel +Z Direction	VDC @ 5V Vcc	4.25	4.50	4.55
Output 1+2 at Full Travel -Z Direction	VDC @ 5V Vcc	0.45	0.50	0.75
Supply Current (per sensor) (B = 0, Vcc = 5V, Io = 0)	mA	N/A	N/A	10
Output - Source Current Limit B = -X, Vo = 0	mA	-1.0	N/A	1.0
Electrical - Joystick Z-Axis 3 Detent				
	Units	Min	Typ	Max
Supply Voltage	VDC	4.5	5	5.5
Output 1+2 Voltage, +Z, -Z 0° Deflection	VDC @ 5V Vcc	2.25	2.50	2.75
Output 1+2 at Full Travel +Z Direction	VDC @ 5V Vcc	4.25	4.50	4.55
Output 1+2 at Full Travel -Z Direction	VDC @ 5V Vcc	0.45	0.50	0.75
Supply current (per sensor) B = 0, Vcc = 5V, Io = 0	mA	N/A	N/A	10.0
Output - Source Current Limit B = -X, Vo = 0	mA	-1.0	N/A	1.0
Z-Axis				
Mechanical Life:	1,000,000 cycles in all directions			
	Units	Min	Typ	Max
Travel Angle (Total)	Degrees	56	60	64
Operational Torque with Detent	OZ	10	20	30
Operational Torque with Friction Hold	OZ	1.0	4.0	7.0
Operational Torque Return to Center	OZ	8.0	16	24
ENVIRONMENTAL:				
Operating Temp Range:	-40°C to +85°C			
Seal:	Electronics without pushbutton sealed to IP68S			
MATERIALS:				
Housing:	Thermoplastic, black			
Bellows:	Silicone, black. Additional materials available, contact factory.			

MINIATURE Z-AXIS HALL EFFECT JOYSTICK

JHT
Z-AXIS MINI
JOYSTICK

COMPACT DESIGN

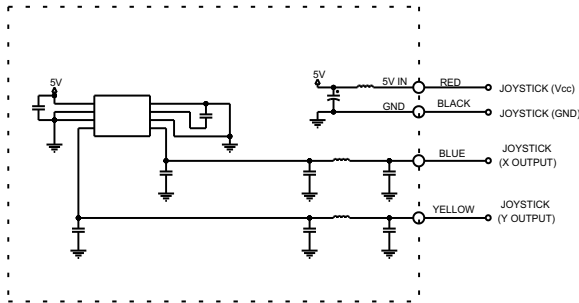

JOYSTICK SCHEMATIC

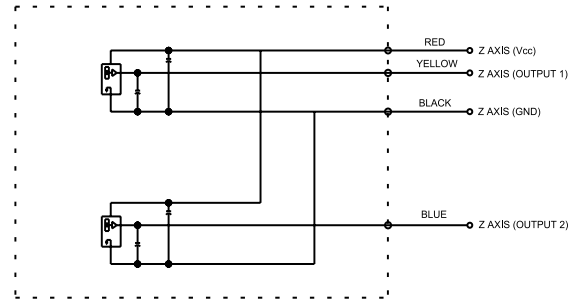

Z AXIS SCHEMATIC

(WIRE BUNDLE 2)
ALL WIRES ARE NOT PRESENT IN ALL CONFIGURATIONS

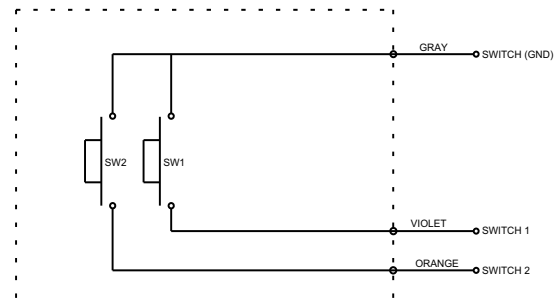
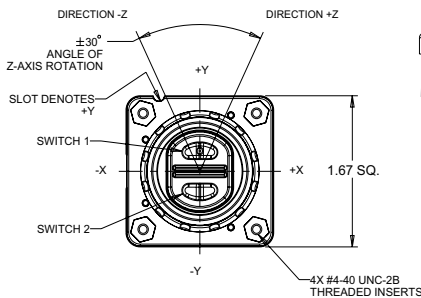
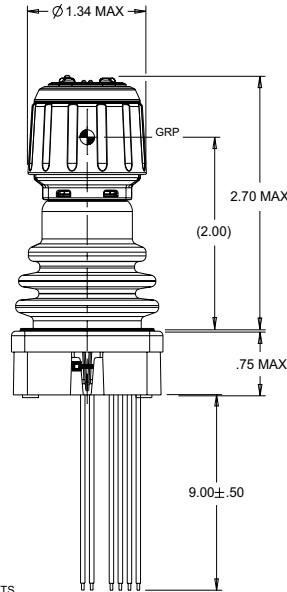
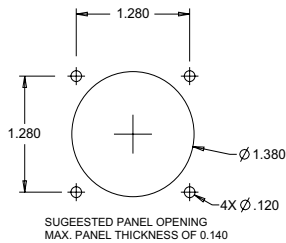

KEYPAD SCHEMATIC

JHT Z-AXIS PART NUMBER CODE

JHT	XX	X	X	XX	X	X
Switch/Boot Style (All Half Boot)	Gating*	Operating Force	Joystick Output 1	Joystick Output 2	Termination	Pushbuttons
32. Z-Axis with Detent, Single Output	1. Gated, Single axis – Return to Center	1.1 lb	AA. 2.5 +/- 2.0VDC	NONE	1.24 AWG	N. None
42. Z-Axis with Friction Hold, Single Output	3. Omni-directional; Round Smooth Feel		BB. 2.5 +/- 2.0VDC	2.5 +/- 2.0VDC	Wire Leads	1. Two Pushbuttons
42. Z-Axis Return to Center, Single Output	4. Omni-directional; On-Axis and Off-Axis Guided Feel		CC. 2.5 +/- 2.0VDC	2.5 +/- 2.0VDC		
62. Z-Axis with Detent, Dual Output	5. Omni-directional; Round On-Axis Guided Feel		DD. 2.5 +/- 1.5VDC	NONE		
72. Z-Axis with Friction Hold, Dual Output			EE. 2.5 +/- 1.5VDC	2.5 +/- 1.5VDC		
82. Z-Axis Return to Center, Dual Output			FF. 2.5 +/- 1.5VDC	2.5 +/- 1.5VDC		
92. Z-Axis with Detent, Single Output with Two Pushbuttons			GG. 0.5 - 4.5VDC	0.5 - 4.5VDC		
A2. Z-Axis with Friction, Single Output with Two Pushbuttons			HH. 1.0 - 4.0VDC	1.0 - 4.0VDC		
B2. Z-Axis Return to Center, Single Output with Two Pushbuttons						
C2. Z-Axis with Detent, Dual Output with Two Pushbuttons						
D2. Z-Axis with Friction, Dual Output with Two Pushbuttons						
E2. Z-Axis Return to Center, Dual Output with Two Pushbuttons						

*Gated = Restricted movement in XY axis only. Gating Icons shown on page 69 in the JHT mini joystick section.

NOTES (Applies to Joystick Output Only):

- Outputs are from the center to the full travel position in each direction.
- Options "AA," "BB," "CC," "DD," "EE" and "FF" provide increased voltage in +X, +Y; and decreasing voltage in -X, -Y direction from one output per axis.
- Options "GG" and "HH" provide increasing voltages in all directions (+X, +Y, -X, -Y) from 2 outputs per axis.
- Options "BB" and "EE" provide redundant output 2 which duplicates output 1. Options "CC" and "FF" provide redundant output 2 which is inverse of output 1.

COMPACT DESIGN

JOYSTICK OUTPUT CONFIGURATION

OPTION AA

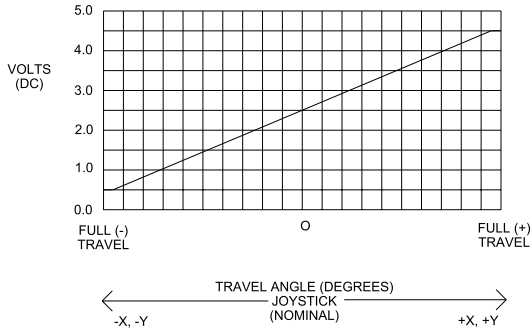

OPTION BB

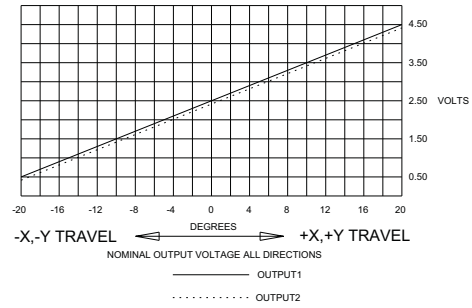

OPTION CC

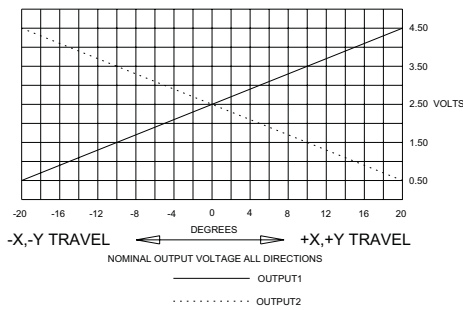

OPTION DD

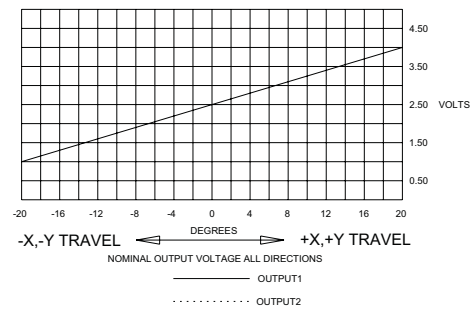

OPTION EE

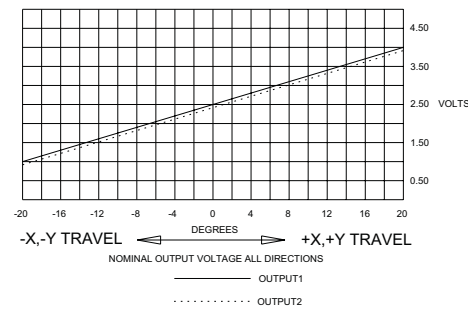

OPTION FF

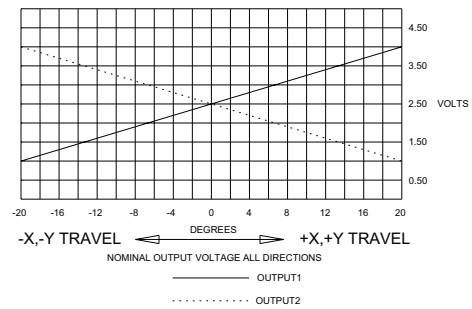

OPTION GG

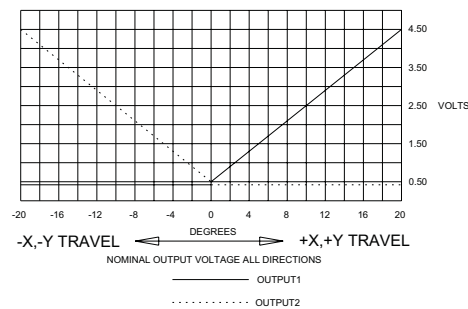

OPTION HH

