

Alle Rechte vorbehalten. All rights reserved

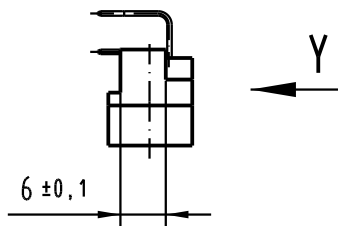

A-B
2:1

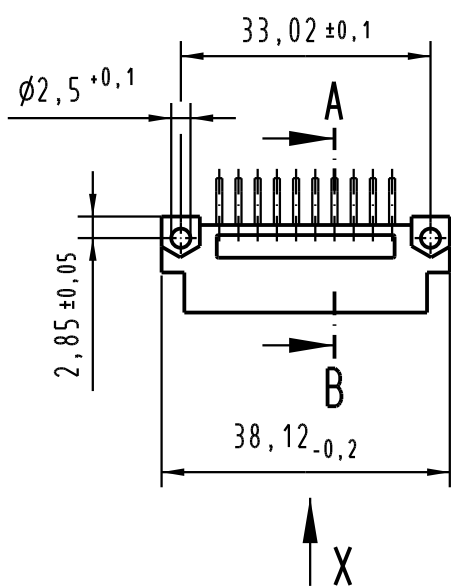
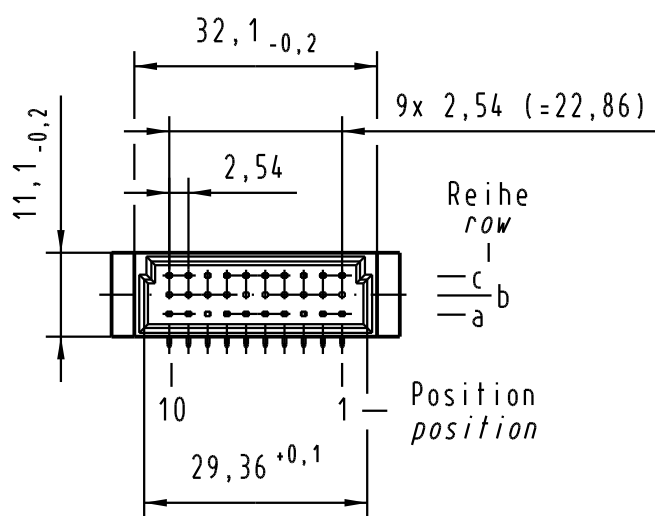
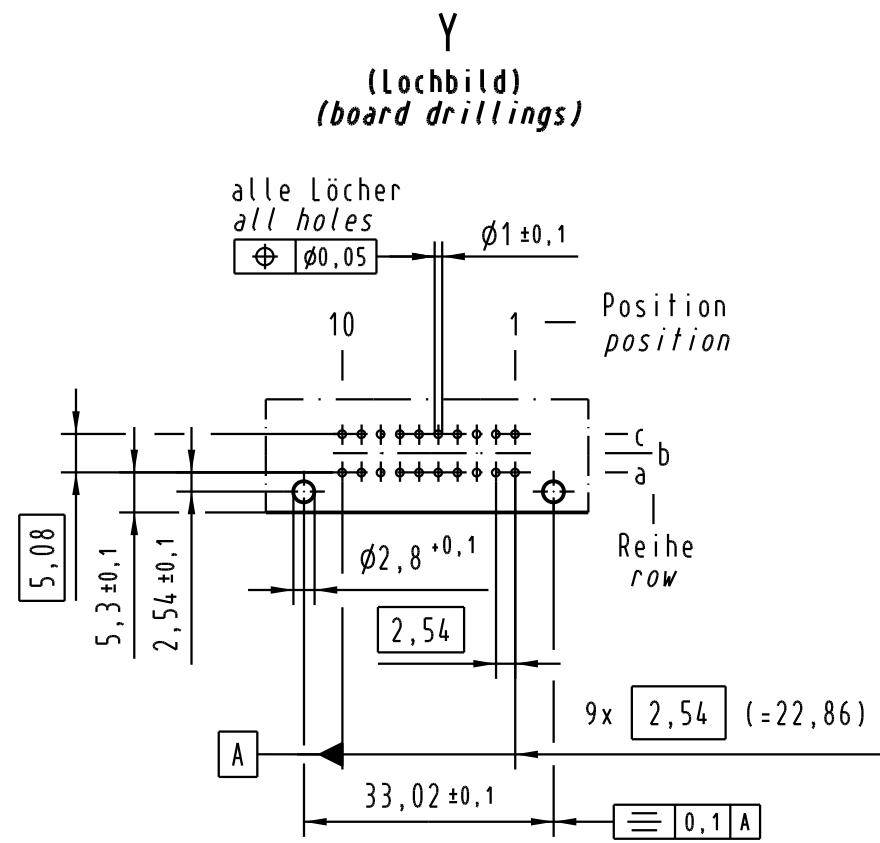
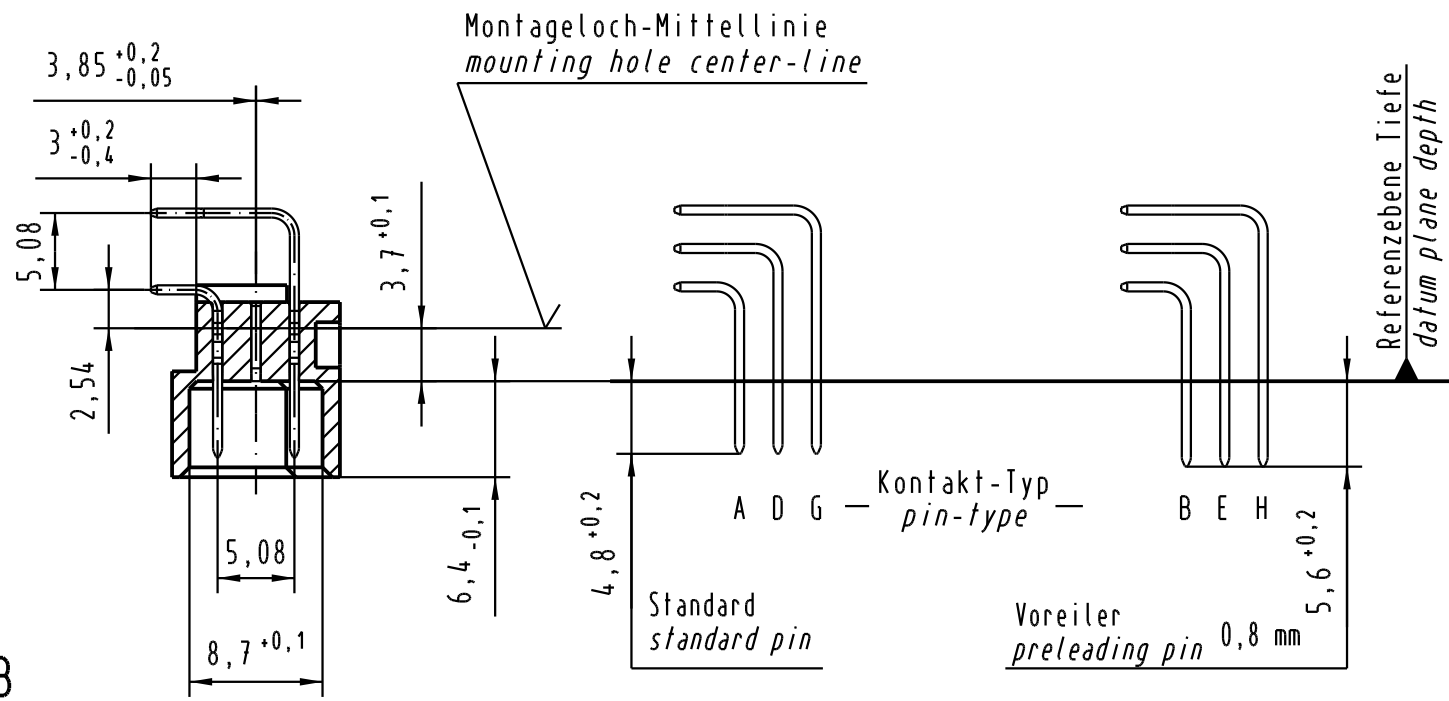

X Kontaktbelegung
contact loading

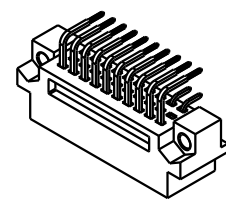
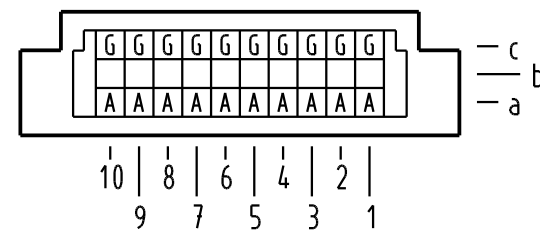

09 25 120 6921	2	Au über/over Ni
Bestell-Nr. part-no.	Anforderungsstufe nach IEC performance level acc. to IEC	Kontaktoberfläche contact plating

33709 Mod.	Dat.	Name	Techn. Character. complementary IEC 60603-2		Nicht tolerierte Maßel Free size tolerances complementary IEC 60603-2	
			Dat.	Name	Bauform 3C Messerleiste Einlöt, 20 pol. type 3C male connector solder, 20 pol.	
			Maßstab/Scale 1:1 (2:1)		TB 09 25 120 x921	
HARTING Electronics GmbH & Co. KG D-32339 ESPELKAMP			HARTING		Sub.	

Blatt / page