

Metallized Polypropylene Film Capacitors DC-Link Capacitor



FEATURES

- High performance DC filter
- Low ESR
- High peak current capabilities
- High RMS current capabilities
- AEC-Q200 qualified
- Mounting: Radial
- Material categorization:
For definitions of compliance please see www.vishay.com/doc?99912

 AUTOMOTIVE
GRADE

RoHS
COMPLIANT

APPLICATIONS

- High performance DC filtering
- HEV/EV: i.e. power train and OBC
- Renewable energies inverters
- Motor drives
- Power supplies

QUICK REFERENCE DATA

Rated capacitance range	1 µF to 400 µF
Capacitance tolerance	5 %
Rated voltage range, U _{NDC}	450 V to 1200 V
Climatic testing class	40/105/56
Rated temperature	85 °C
Maximum permissible case temperature	105 °C, observing voltage derating
Maximum applicable peak to peak ripple voltage	0.2 x U _{NDC}
Reference standards	IEC 61071, IEC 60068
Dielectric	Polypropylene film
Electrodes	Metallized dielectric capacitor
Construction	Mono construction
Encapsulation	Plastic case, sealed with resin; flame retardant
Terminals	Tinned wires
Self inductance (L _s)	< 1 nH per mm of lead spacing
Withstanding DC voltage between terminals ⁽¹⁾	1.5 U _{NDC} for 10 s, cut off current 10 mA, rise time ≤ 1000 V/s
Insulation resistance	RC between leads, after 1 min > 10 000 s For U _{NDC} ≤ 500 V measuring voltage 100 V For U _{NDC} > 500 V measuring voltage 500 V
Life time expectancy	Useful life time: > 100 000 h at U _{NDC} and 70 °C FIT: < 10 x 10 ⁻⁹ /h (10 per 10 ⁹ component h) at 0.5 x U _{NDC} , 40 °C
Marking	C-value; tolerance; rated voltage; code for dielectric material; code for manufacturing origin; manufacturer's type designation; manufacturer's logo; year and week of manufacture

Notes

- For more detailed data and test requirements, contact dc-film@vishay.com
- For general information like characteristics and definitions used for film capacitors follow the link: www.vishay.com/doc?28147
- ⁽¹⁾ See document "Voltage Proof Test for Metallized Film Capacitors" (www.vishay.com/doc?28169)

DC VOLTAGE RATINGS

U _{NDC} at 85 °C	450 V	700 V	800 V	900 V	1100 V	1200 V
U _{OPDC} at 70 °C	500 V	800 V	900 V	1100 V	1350 V	1500 V
U _{OPDC} at 105 °C	300 V	500 V	570 V	650 V	800 V	850 V

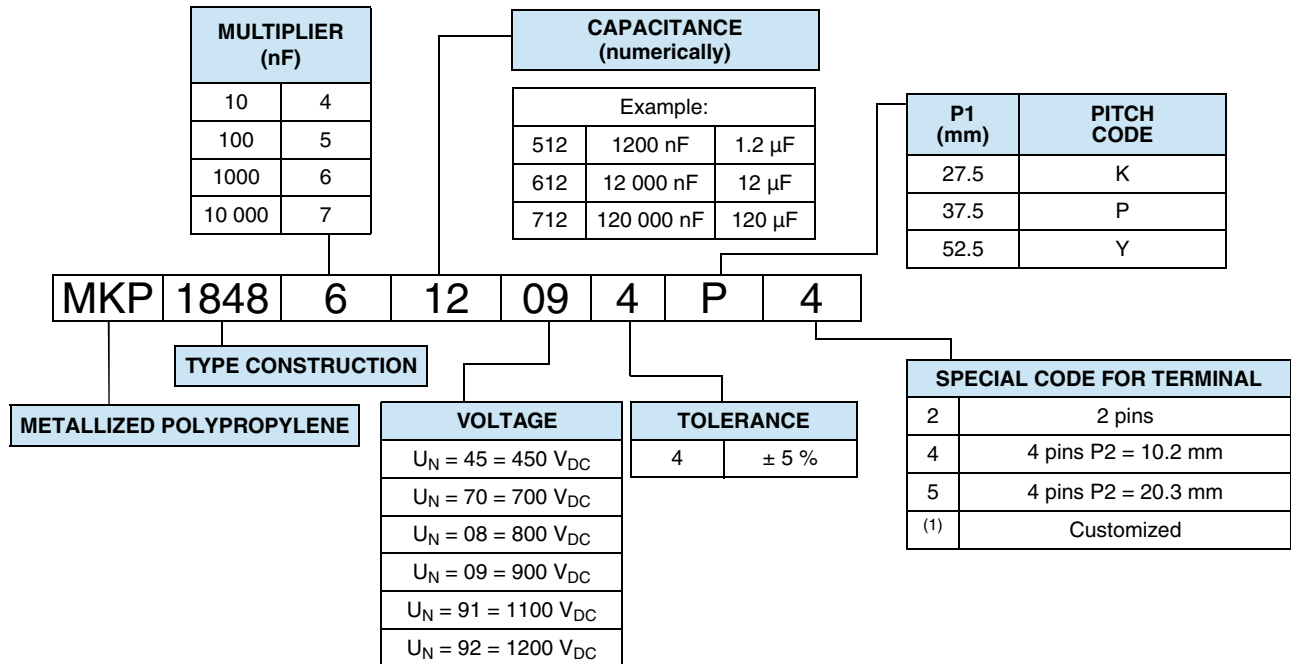
COMPOSITION OF CATALOG NUMBER

Note

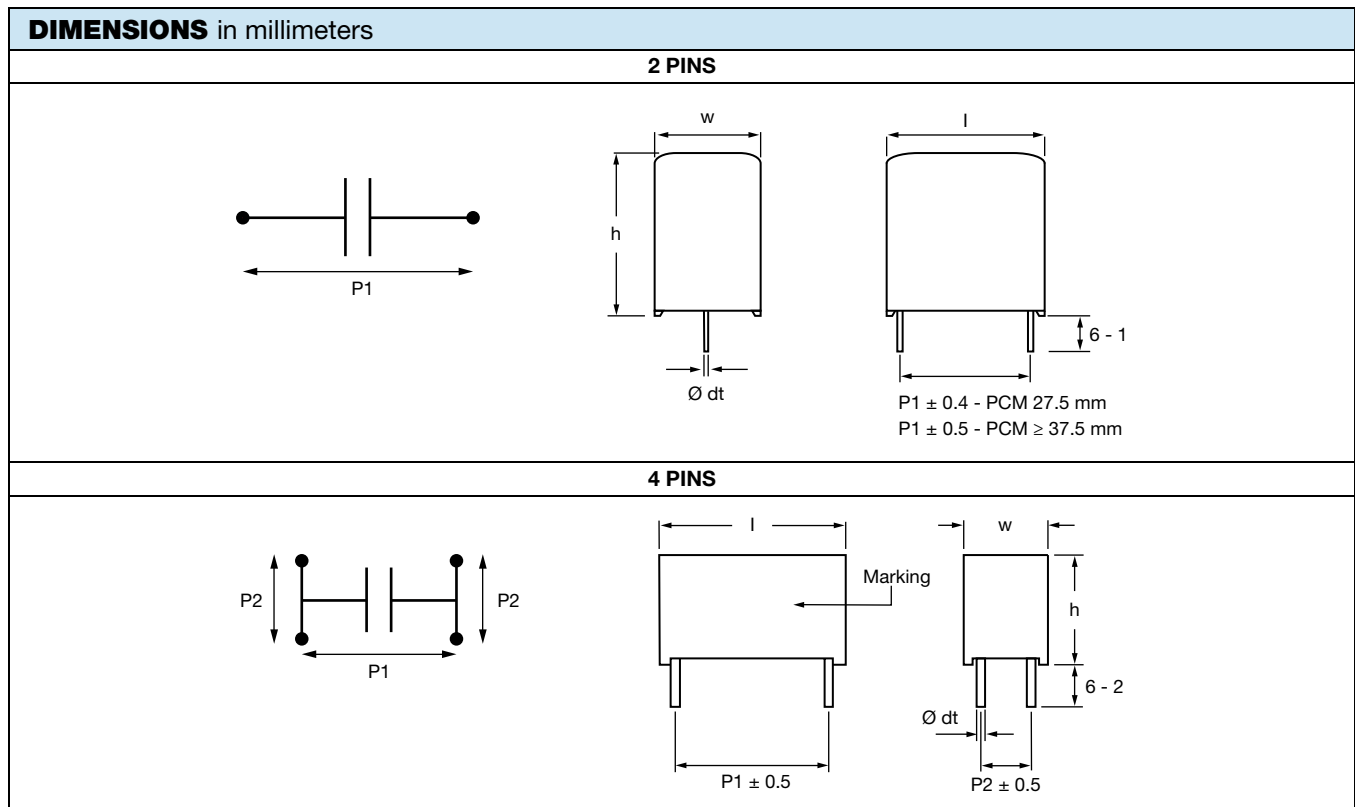
(1) Tabs terminals or customized terminals are available on request

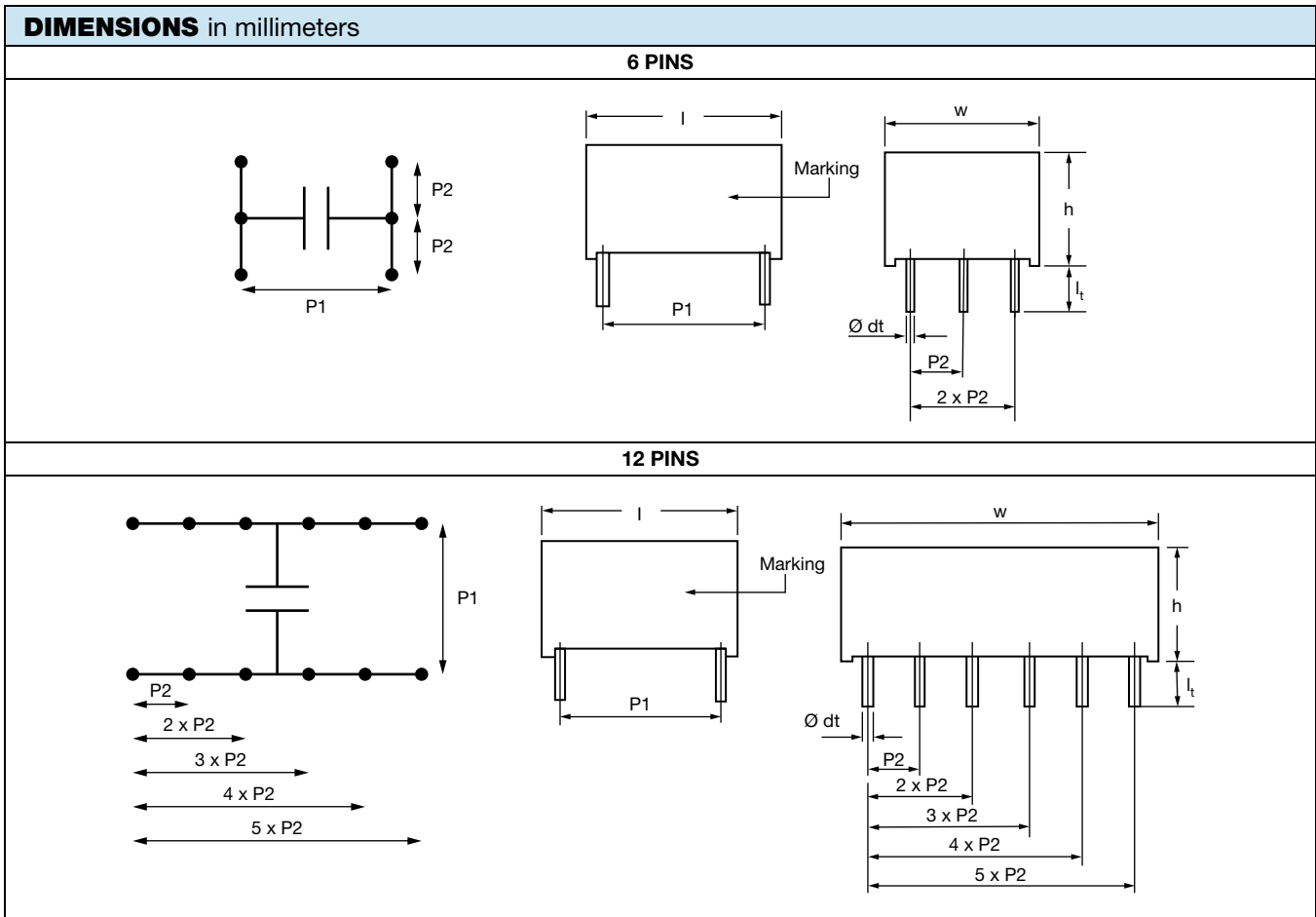

Note

- $\varnothing dt \pm 10\%$ of standard diameter specified

ELECTRICAL DATA AND ORDERING CODE															
U_{NDC} AT 85 °C (V)	CAP. ⁽⁸⁾ (μ F)	DIMENSION ⁽⁵⁾ (mm)			P1 (mm)	P2 (mm)	dV/dt (V/ μ s)	I_{PEAK} (A)	I_{RMS} ⁽²⁾ (A)		ESR ⁽³⁾ (m Ω)		$\tan \delta$ 10 kHz ($< 10^{-4}$) ⁽⁴⁾		ORDERING CODE ⁽¹⁾
		w	h	l					2 PINS	4 PINS	2 PINS	4 PINS	2 PINS	4 PINS	
U_{OPDC} AT 70 °C = 500 V, U_{OPDC} AT 105 °C = 300 V															
450	1	9.0	19.0	32.0	27.5	-	75	75	2.5	-	54	-	85	-	MKP1848510454K2
	2	9.0	19.0	32.0	27.5	-	75	150	3	-	34.5	-	85	-	MKP1848520454K2
	3	11.0	21.0	32.0	27.5	-	75	225	4	-	23.0	-	85	-	MKP1848530454K2
	4	11.0	21.0	32.0	27.5	-	75	300	4	-	20.5	-	85	-	MKP1848540454K2
	5	13.0	23.0	32.0	27.5	-	75	375	5	-	16.5	-	85	-	MKP1848550454K2
	6	15.0	25.0	32.0	27.5	-	75	450	6	-	13.5	-	85	-	MKP1848560454K2
	7	15.0	25.0	32.0	27.5	-	75	525	6.5	-	11.5	-	85	-	MKP1848570454K2
	8	18.0	28.0	32.0	27.5	-	75	600	8.5	-	8.5	-	85	-	MKP1848580454K2
	9	18.0	28.0	32.0	27.5	-	75	675	8.5	-	9.0	-	85	-	MKP1848590454K2
	10	18.0	28.0	32.0	27.5	-	75	750	9	-	8.0	-	85	-	MKP1848610454K2
	12	21.0	31.0	32.0	27.5	-	75	900	10	-	7.0	-	85	-	MKP1848612454K2
	15	20.0	35.0	32.0	27.5	-	75	1125	11.5	-	6.0	-	85	-	MKP1848615454K2
10	18.5	35.5	43.0	37.5	10.2	40	400	7.5	8	13.5	12.0	160	140	MKP1848610454P*	



ELECTRICAL DATA AND ORDERING CODE															
U _{NDC} AT 85 °C (V)	CAP. ⁽⁶⁾ (µF)	DIMENSION ⁽⁵⁾ (mm)			P1 (mm)	P2 (mm)	dV/dt (V/µs)	I _{PEAK} (A)	I _{RMS} ⁽²⁾ (A)		ESR ⁽³⁾ (mΩ)		tan δ 10 kHz ($< 10^{-4}$) ⁽⁴⁾		ORDERING CODE ⁽¹⁾
		w	h	l					2 PINS	4 PINS	2 PINS	4 PINS	2 PINS	4 PINS	
		U _{OPDC} AT 70 °C = 500 V, U _{OPDC} AT 105 °C = 300 V													
450	12	18.5	35.5	43.0	37.5	10.2	40	480	8	8.5	11.5	10.0	160	140	MKP1848612454P*
	15	18.5	35.5	43.0	37.5	10.2	40	600	9	10	9.0	8.0	160	140	MKP1848615454P*
	20	21.5	38.5	43.0	37.5	10.2	40	800	11	12	7.0	6.0	160	140	MKP1848620454P*
	22	21.5	38.5	43.0	37.5	10.2	40	880	11	11.5	7.5	6.5	160	140	MKP1848622454P*
	25	21.5	38.5	43.0	37.5	10.2	40	1000	11.5	12.5	6.5	5.5	160	140	MKP1848625454P*
	30	24.0	44.0	42.0	37.5	10.2	40	1200	13.5	15	5.5	4.5	160	140	MKP1848630454P*
	35	30.0	45.0	42.0	37.5	10.2/20.3	40	1400	17	18.5	4.0	3.5	160	140	MKP1848635454P*
	40	30.0	45.0	42.0	37.5	10.2/20.3	40	1600	17	18.5	4.0	3.5	160	140	MKP1848640454P*
	40	25.0	45.0	57.5	52.5	10.2	20	800	13	13.5	6.5	6.0	310	280	MKP1848640454Y*
	45	25.0	45.0	57.5	52.5	10.2	20	900	12.5	13.5	7.0	6.0	310	280	MKP1848645454Y*
	50	30.0	45.0	57.5	52.5	20.3	20	1000	15	15.5	5.5	5.0	310	280	MKP1848650454Y*
	55	30.0	45.0	57.5	52.5	20.3	20	1100	15	15.5	5.5	5.0	310	280	MKP1848655454Y*
	60	30.0	45.0	57.5	52.5	20.3	20	1200	15.5	16.5	5.0	4.5	310	280	MKP1848660454Y*
	65	35.0	50.0	57.5	52.5	20.3	20	1300	19	20.5	4.0	3.5	310	280	MKP1848665454Y*
	70	35.0	50.0	57.5	52.5	20.3	20	1400	18	19	4.5	4.0	310	280	MKP1848670454Y*
	75	35.0	50.0	57.5	52.5	20.3	20	1500	19	20.5	4.0	3.5	310	280	MKP1848675454Y*
	80	35.0	50.0	57.5	52.5	20.3	20	1600	19	20.5	4.0	3.5	310	280	MKP1848680454Y*
	90	45.0	45.0	57.5	52.5	20.3	20	1800	-	21.5	-	3.0	-	280	MKP1848690454Y5
95	45.0	45.0	57.5	52.5	20.3	20	1900	-	21.5	-	3.0	-	280	MKP1848695454Y5	
100	45.0	45.0	57.5	52.5	20.3	20	2000	-	23.5	-	2.5	-	280	MKP1848710454Y5	
200	70.0	65.0	57.5	52.5	20.3	20	2000	-	30.5	-	2.0	-	310	MKP1848720454Y5 ⁽⁶⁾	
400	130	65.0	57.5	52.5	20.3	10	4000	-	50.5	-	1.5	-	380	MKP1848740454Y5 ⁽⁷⁾	
700	U _{OPDC} AT 70 °C = 800 V, U _{OPDC} AT 105 °C = 500 V														
	1	9	19	32	27.5	-	75	75	2.5	-	54	-	68	-	MKP1848510704K2
	2	9	19	32	27.5	-	75	150	3	-	34.5	-	68	-	MKP1848520704K2
	3	11	21	32	27.5	-	75	225	4	-	23	-	68	-	MKP1848530704K2
	4	13	23	32	27.5	-	75	300	5	-	17	-	68	-	MKP1848540704K2
	5	15	25	32	27.5	-	75	375	6	-	14	-	68	-	MKP1848550704K2
	6	18	28	32	27.5	-	75	450	7.5	-	11.5	-	68	-	MKP1848560704K2
	7	18	28	32	27.5	-	75	525	8	-	10	-	68	-	MKP1848570704K2
	8	18	28	32	27.5	-	75	600	8.5	-	8.5	-	68	-	MKP1848580704K2
	9	21	31	32	27.5	-	75	675	10	-	7.5	-	68	-	MKP1848590704K2
	10	21	31	32	27.5	-	75	750	10	-	7	-	68	-	MKP1848610704K2
	12	20	35	32	27.5	-	75	900	11.5	-	6	-	68	-	MKP1848612704K2
	10	18.5	35.5	43	37.5	10.2	40	400	7.5	8	13.5	12	135	120	MKP1848610704P*
	12	18.5	35.5	43	37.5	10.2	40	480	8	8.5	11.5	10	135	120	MKP1848612704P*
	15	18.5	35.5	43	37.5	10.2	40	600	9	10	9	8	135	120	MKP1848615704P*
	20	21.5	38.5	43	37.5	10.2	40	800	11	12	7	6	135	120	MKP1848620704P*
	22	24	44	42	37.5	10.2	40	880	13	13.5	6	5.5	135	120	MKP1848622704P*
	25	24	44	42	37.5	10.2	40	1000	13.5	14.5	5.5	5	135	120	MKP1848625704P*
30	30	45	42	37.5	10.2/20.3	40	1200	16	17	4.5	4	135	120	MKP1848630704P*	



ELECTRICAL DATA AND ORDERING CODE															
U _{NDC} AT 85 °C (V)	CAP. ⁽⁶⁾ (μF)	DIMENSION ⁽⁵⁾ (mm)			P1 (mm)	P2 (mm)	dV/dt (V/μs)	I _{PEAK} (A)	I _{RMS} ⁽²⁾ (A)		ESR ⁽³⁾ (mΩ)		tan δ 10 kHz ($< 10^{-4}$) ⁽⁴⁾		ORDERING CODE ⁽¹⁾
		w	h	l					2 PINS	4 PINS	2 PINS	4 PINS	2 PINS	4 PINS	
		U _{OPDC} AT 70 °C = 800 V, U _{OPDC} AT 105 °C = 500 V													
700	35	30	45	42	37.5	10.2/20.3	40	1400	17	18.5	4	3.5	135	120	MKP1848635704P*
	30	25	45	57.5	52.5	10.2	20	600	11	12	9	8	270	240	MKP1848630704Y*
	35	25	45	57.5	52.5	10.2	20	700	12	12.5	7.5	7	270	240	MKP1848635704Y*
	40	25	45	57.5	52.5	10.2	20	800	13	13.5	6.5	6	270	240	MKP1848640704Y*
	45	30	45	57.5	52.5	20.3	20	900	14.5	15	6	5.5	270	240	MKP1848645704Y*
	50	30	45	57.5	52.5	20.3	20	1000	15	15.5	5.5	5	270	240	MKP1848650704Y*
	55	35	50	57.5	52.5	20.3	20	1100	17	18	5	4.5	270	240	MKP1848655704Y*
	60	35	50	57.5	52.5	20.3	20	1200	18	19	4.5	4	270	240	MKP1848660704Y*
	65	35	50	57.5	52.5	20.3	20	1300	19	20.5	4	3.5	270	240	MKP1848665704Y*
	70	45	45	57.5	52.5	20.3	20	1400	-	20	-	3.5	-	240	MKP1848670704Y5
	75	45	45	57.5	52.5	20.3	20	1500	-	21.5	-	3	-	240	MKP1848675704Y5
	80	45	45	57.5	52.5	20.3	20	1600	-	21.5	-	3	-	240	MKP1848680704Y5
	160	70	65	57.5	52.5	20.3	20	3200	-	30.5	-	2.5	-	280	MKP1848716704Y5 ⁽⁶⁾
320	130	65	57.5	52.5	20.3	20	6400	-	54	-	1.3	-	280	MKP1848732704Y5 ⁽⁷⁾	
800	U _{OPDC} AT 70 °C = 900 V, U _{OPDC} AT 105 °C = 570 V														
	1	9	19	32	27.5	-	75	75	2	-	62.5	-	60	-	MKP1848510084K2
	2	11	21	32	27.5	-	75	150	3.5	-	31	-	60	-	MKP1848520084K2
	3	13	23	32	27.5	-	75	225	4.5	-	21	-	60	-	MKP1848530084K2
	4	15	25	32	27.5	-	75	300	5.5	-	15.5	-	60	-	MKP1848540084K2
	5	18	28	32	27.5	-	75	375	7	-	12.5	-	60	-	MKP1848550084K2
	6	18	28	32	27.5	-	75	450	7.5	-	10.5	-	60	-	MKP1848560084K2
	7	21	31	32	27.5	-	75	525	9	-	9	-	60	-	MKP1848570084K2
	8	21	31	32	27.5	-	75	600	9.5	-	8	-	60	-	MKP1848580084K2
	9	20	35	32	27.5	-	75	675	10	-	8	-	60	-	MKP1848590084K2
	10	18.5	35.5	43	37.5	10.2	40	400	8	8.5	12.5	11	122	110	MKP1848610084P*
	12	18.5	35.5	43	37.5	10.2	40	480	8.5	9	10.5	9	122	110	MKP1848612084P*
	15	21.5	38.5	43	37.5	10.2	40	600	10	11	8.5	7.5	122	110	MKP1848615084P*
	20	24	44	42	37.5	10.2	40	800	13	13.5	6	5.5	122	110	MKP1848620084P*
	22	30	45	42	37.5	10.2/20.3	40	880	14.5	15.5	5.5	5	122	110	MKP1848622084P*
	25	30	45	42	37.5	10.2/20.3	40	1000	15.5	16	5	4.5	122	110	MKP1848625084P*
	30	25	45	57.5	52.5	10.2	10	300	12	12	8	7.5	240	215	MKP1848630084Y*
	35	30	45	57.5	52.5	20.3	10	350	13	14.5	7	6	240	215	MKP1848635084Y*
	40	30	45	57.5	52.5	20.3	10	400	14.5	15	6	5.5	240	215	MKP1848640084Y*
	45	35	50	57.5	52.5	20.3	10	450	16	17	5.5	5	240	215	MKP1848645084Y*
	50	35	50	57.5	52.5	20.3	10	500	17	18	5	4.5	240	215	MKP1848650084Y*
55	45	45	57.5	52.5	20.3	10	550	-	18.5	-	4	-	215	MKP1848655084Y5	
60	45	45	57.5	52.5	20.3	10	600	-	20	-	3.5	-	215	MKP1848660084Y5	
120	70	65	57.5	52.5	20.3	10	1600	-	27	-	3.2	-	215	MKP1848712084Y5 ⁽⁶⁾	
240	130	65	57.5	52.5	20.3	10	3200	-	48.5	-	1.6	-	215	MKP1848724084Y5 ⁽⁷⁾	



ELECTRICAL DATA AND ORDERING CODE															
U _{NDC} AT 85 °C (V)	CAP. ⁽⁶⁾ (µF)	DIMENSION ⁽⁵⁾ (mm)			P1 (mm)	P2 (mm)	dV/dt (V/µs)	I _{PEAK} (A)	I _{RMS} ⁽²⁾ (A)		ESR ⁽³⁾ (mΩ)		tan δ 10 kHz ($< 10^{-4}$) ⁽⁴⁾		ORDERING CODE ⁽¹⁾
		w	h	l					2 PINS	4 PINS	2 PINS	4 PINS	2 PINS	4 PINS	
		U _{OPDC} AT 70 °C = 1100 V, U _{OPDC} AT 105 °C = 650 V													
900	1	9	19	32	27.5	-	40	40	2	-	63	-	50	-	MKP1848510094K2
	2	13	23	32	27.5	-	80	160	3.5	-	32	-	50	-	MKP1848520094K2
	3	15	25	32	27.5	-	80	240	5	-	21	-	50	-	MKP1848530094K2
	4	18	28	32	27.5	-	80	320	6	-	16	-	50	-	MKP1848540094K2
	5	21	31	32	27.5	-	80	400	7.5	-	13	-	50	-	MKP1848550094K2
	6	21	31	32	27.5	-	80	480	8.5	-	10	-	50	-	MKP1848560094K2
	7	20	35	32	27.5	-	80	560	9	-	9	-	50	-	MKP1848570094K2
	5	18.5	35.5	43	37.5	10.2	20	100	6	6.5	21	19	100	90	MKP1848550094P*
	6	18.5	35.5	43	37.5	10.2	40	240	6.5	7	18	16	100	90	MKP1848560094P*
	7	18.5	35.5	43	37.5	10.2	40	280	6.5	7	18	16	100	90	MKP1848570094P*
	8	18.5	35.5	43	37.5	10.2	40	320	7	7.5	16	14	100	90	MKP1848580094P*
	9	18.5	35.5	43	37.5	10.2	40	360	7.5	8	14	12	100	90	MKP1848590094P*
	10	21.5	38.5	43	37.5	10.2	40	400	8.5	9	12	11	100	90	MKP1848610094P*
	12	21.5	38.5	43	37.5	10.2	40	480	9.5	10	10	9	100	90	MKP1848612094P*
	15	24	44	42	37.5	10.2	40	600	11	12	8	7	100	90	MKP1848615094P*
	16	24	44	42	37.5	10.2	40	640	11	12	8	7	100	90	MKP1848616094P*
	20	30	45	42	37.5	10.2/20.3	40	800	14	15.5	6	5	100	90	MKP1848620094P*
	15	25	45	57.5	52.5	10.2	20	300	9	9.5	14	12	200	185	MKP1848615094Y*
	20	25	45	57.5	52.5	10.2	20	400	9.5	10	12	11	200	185	MKP1848620094Y*
	22	25	45	57.5	52.5	10.2	20	440	10	10.5	11	10	200	185	MKP1848622094Y*
25	30	45	57.5	52.5	20.3	20	500	11	11.5	10	9	200	185	MKP1848625094Y*	
30	30	45	57.5	52.5	20.3	20	600	12.5	13	8	7	200	185	MKP1848630094Y*	
35	35	50	57.5	52.5	20.3	20	700	14.5	15.5	7	6	200	185	MKP1848635094Y*	
40	35	50	57.5	52.5	20.3	20	800	15.5	17	6	5	200	185	MKP1848640094Y*	
45	45	45	57.5	52.5	20.3	20	900	-	16.5	-	5	-	185	MKP1848645094Y5	
50	45	45	57.5	52.5	20.3	20	1000	-	18.5	-	4	-	185	MKP1848650094Y5	
100	70	65	57.5	52.5	20.3	20	2000	-	26.5	-	3.3	-	205	MKP1848710094Y5 ⁽⁶⁾	
200	130	65	57.5	52.5	20.3	20	4000	-	48.5	-	1.6	-	205	MKP1848720094Y5 ⁽⁷⁾	
1100	U _{OPDC} AT 70 °C = 1350 V, U _{OPDC} AT 105 °C = 800 V														
	1	11	21	32	27.5	-	95	95	3	-	45.5	-	45	-	MKP1848510914K2
	2	15	25	32	27.5	-	95	190	4.5	-	23	-	45	-	MKP1848520914K2
	3	18	28	32	27.5	-	95	285	6	-	15.5	-	45	-	MKP1848530914K2
	4	21	31	32	27.5	-	95	380	8	-	11.5	-	45	-	MKP1848540914K2
	5	20	35	32	27.5	-	95	475	9	-	9.5	-	45	-	MKP1848550914K2
	5	18.5	35.5	43	37.5	10.2	45	225	6.5	7	18	16	90	80	MKP1848550914P*
	6	18.5	35.5	43	37.5	10.2	45	270	7	7.5	15	13.5	90	80	MKP1848560914P*
	7	21.5	38.5	43	37.5	10.2	45	315	8	8.5	13	11.5	90	80	MKP1848570914P*
	8	21.5	38.5	43	37.5	10.2	45	360	9	9.5	11	10	90	80	MKP1848580914P*
	9	24	44	42	37.5	10.2	45	405	10	10.5	10	9	90	80	MKP1848590914P*
	10	24	44	42	37.5	10.2	45	450	10.5	11	9	8	90	80	MKP1848610914P*
	12	30	45	42	37.5	10.2/20.3	45	540	12.5	13.5	7.5	6.5	90	80	MKP1848612914P*



ELECTRICAL DATA AND ORDERING CODE															
U _{NDC} AT 85 °C (V)	CAP. ⁽⁶⁾ (µF)	DIMENSION ⁽⁵⁾ (mm)			P1 (mm)	P2 (mm)	dV/dt (V/µs)	I _{PEAK} (A)	I _{RMS} ⁽²⁾ (A)		ESR ⁽³⁾ (mΩ)		tan δ 10 kHz ($< 10^{-4}$) ⁽⁴⁾		ORDERING CODE ⁽¹⁾
		w	h	l					2 PINS	4 PINS	2 PINS	4 PINS	2 PINS	4 PINS	
		U _{OPDC} AT 70 °C = 1350 V, U _{OPDC} AT 105 °C = 800 V													
1100	10	25	45	57.5	52.5	10.2	23	230	8	8.5	18	16	175	155	MKP1848610914Y*
	12	25	45	57.5	52.5	10.2	23	276	8.5	9	15	13	175	155	MKP1848612914Y*
	15	25	45	57.5	52.5	10.2	23	345	9.5	10.5	12	10.5	175	155	MKP1848615914Y*
	20	30	45	57.5	52.5	20.3	23	460	11.5	12.5	9	8	175	155	MKP1848620914Y*
	22	35	50	57.5	52.5	20.3	23	506	13.5	14.5	8	7	175	155	MKP1848622914Y*
	25	35	50	57.5	52.5	20.3	23	575	14.5	15	7	6.5	175	155	MKP1848625914Y*
	30	45	45	57.5	52.5	20.3	23	690	-	16.5	-	5	-	155	MKP1848630914Y5
	60	70	65	57.5	52.5	20.3	23	1380	-	40	-	2.5	-	180	MKP1848660914Y5 ⁽⁶⁾
	70	70	65	57.5	52.5	20.3	23	1610	-	34.5	-	2	-	180	MKP1848670914Y5 ⁽⁶⁾
	120	130	65	57.5	52.5	20.3	23	2760	-	39.5	-	2.4	-	180	MKP1848712914Y5 ⁽⁷⁾
140	130	65	57.5	52.5	20.3	23	3220	-	43.5	-	2	-	180	MKP1848714914Y5 ⁽⁷⁾	
1200	U _{OPDC} AT 70 °C = 1500 V, U _{OPDC} AT 105 °C = 850 V														
	1	11	21	32	27.5	-	100	100	3	-	43	-	40	-	MKP1848510924K2
	2	15	25	32	27.5	-	100	200	5	-	21.5	-	40	-	MKP1848520924K2
	3	18	28	32	27.5	-	100	300	6.5	-	14.5	-	40	-	MKP1848530924K2
	4	21	31	32	27.5	-	100	400	8	-	11	-	40	-	MKP1848540924K2
	5	18.5	35.5	43	37.5	10.2	48	240	6.5	7	17	15	80	70	MKP1848550924P*
	6	18.5	35.5	43	37.5	10.2	48	288	7.5	8	14	12.5	80	70	MKP1848560924P*
	7	21.5	38.5	43	37.5	10.2	48	336	8.5	9	12	11	80	70	MKP1848570924P*
	8	21.5	38.5	43	37.5	10.2	48	384	9	9.5	10.5	9.5	80	70	MKP1848580924P*
	9	24	44	42	37.5	10.2	48	432	10.5	11	9.5	8.5	80	70	MKP1848590924P*
	10	24	44	42	37.5	10.2	48	480	11	11.5	8.5	7.5	80	70	MKP1848610924P*
	12	30	45	42	37.5	10.2/20.3	48	576	13	13.5	7	6.5	80	70	MKP1848612924P*
	10	25	45	57.5	52.5	10.2	24	240	8	8.5	17	15	165	150	MKP1848610924Y*
	12	25	45	57.5	52.5	10.2	24	288	9	9.5	14	12.5	165	150	MKP1848612924Y*
	15	25	45	57.5	52.5	10.2	24	360	10	10.5	11	10	165	150	MKP1848615924Y*
	20	35	50	57.5	52.5	20.3	24	480	13	14	8.5	7.5	165	150	MKP1848620924Y*
	22	35	50	57.5	52.5	20.3	24	528	14	14.5	7.5	7	165	150	MKP1848622924Y*
	25	35	50	57.5	52.5	20.3	24	600	15	15.5	6.5	6	165	150	MKP1848625924Y*
	30	45	45	57.5	52.5	20.3	24	720	-	16.5	-	5	-	150	MKP1848630924Y5
	60	70	65	57.5	52.5	20.3	24	1440	-	23	-	4.5	-	170	MKP1848660924Y5 ⁽⁶⁾
120	130	65	57.5	52.5	20.3	24	2280	-	40.5	-	2.3	-	170	MKP1848712924Y5 ⁽⁷⁾	

Notes

- (1) Change the * symbol with special code for the terminals
- (2) Maximum RMS current at 10 kHz, + 85 °C, Δt = + 15 °C, capacitance tolerance ≤ ± 5 %
- (3) Equivalent series resistance typical values at f = 10 kHz to 100 kHz for P = 27.5 mm, at f = 10 kHz to 70 kHz for P = 37.5 mm, at f = 10 kHz to 50 kHz for P = 52.5 mm
- (4) Maximum tan δ values
- (5) Standard dimension
- (6) 6 pins
- (7) 12 pins
- (8) Intermediate capacitance values available on request



PACKAGING INFORMATION						
U _{NDC} AT 85 °C (V)	HEIGHT (mm)	CAP. ⁽⁵⁾ (µF)	Ø dt	ORDERING CODE ⁽¹⁾	MASS (g)	SPQ ⁽²⁾ (pcs)
450	U _{OPDC} AT 70 °C = 500 V, U _{OPDC} AT 105 °C = 300 V					
	19	1	0.8	MKP1848510454K2	6	160
	19	2	0.8	MKP1848520454K2	5.5	160
	21	3	0.8	MKP1848530454K2	8.5	130
	21	4	0.8	MKP1848540454K2	8.5	130
	23	5	0.8	MKP1848550454K2	10.5	115
	25	6	0.8	MKP1848560454K2	12.5	100
	25	7	0.8	MKP1848570454K2	11.5	100
	28	8	0.8	MKP1848580454K2	15	80
	28	9	0.8	MKP1848590454K2	16	80
	28	10	0.8	MKP1848610454K2	15	80
	31	12	0.8	MKP1848612454K2	21.5	65
	35	15	0.8	MKP1848615454K2	20	70
	35.5	10	1.0	MKP1848610454P*	34	105
	35.5	12	1.0	MKP1848612454P*	32	105
	35.5	15	1.0	MKP1848615454P*	30	105
	38.5	20	1.0	MKP1848620454P*	36	91
	38.5	22	1.0	MKP1848622454P*	38	91
	38.5	25	1.0	MKP1848625454P*	36	91
	44	30	1.0	MKP1848630454P*	48	77
	45	35	1.0	MKP1848635454P*	57	63
	45	40	1.0	MKP1848640454P*	60	63
	45	40	1.2	MKP1848640454Y*	66	55
	45	45	1.2	MKP1848645454Y*	70	55
	45	50	1.2	MKP1848650454Y*	88	45
	45	55	1.2	MKP1848655454Y*	96	45
	45	60	1.2	MKP1848660454Y*	91	45
	50	65	1.2	MKP1848665454Y*	100	40
	50	70	1.2	MKP1848670454Y*	112	40
	50	75	1.2	MKP1848675454Y*	108	40
50	80	1.2	MKP1848680454Y*	102	40	
45	90	1.2	MKP1848690454Y5	127	30	
45	95	1.2	MKP1848695454Y5	124	30	
45	100	1.2	MKP1848710454Y5	120	30	
65	200	1.2	MKP1848720454Y5 ⁽³⁾	266	20	
65	400	1.2	MKP1848740454Y5 ⁽⁴⁾	490	10	
700	U _{OPDC} AT 70 °C = 800 V, U _{OPDC} AT 105 °C = 500 V					
	19	1	0.8	MKP1848510704K2	6	160
	19	2	0.8	MKP1848520704K2	5.5	160
	21	3	0.8	MKP1848530704K2	8.5	130
	23	4	0.8	MKP1848540704K2	10.5	115
	25	5	0.8	MKP1848550704K2	12	100
	28	6	0.8	MKP1848560704K2	17	80
	28	7	0.8	MKP1848570704K2	16	80



PACKAGING INFORMATION						
U _{NDC} AT 85 °C (V)	HEIGHT (mm)	CAP. ⁽⁵⁾ (µF)	Ø dt	ORDERING CODE ⁽¹⁾	MASS (g)	SPQ ⁽²⁾ (pcs)
700	U_{OPDC} AT 70 °C = 800 V, U_{OPDC} AT 105 °C = 500 V					
	28	8	0.8	MKP1848580704K2	15	80
	31	9	0.8	MKP1848590704K2	22	65
	31	10	0.8	MKP1848610704K2	21	65
	35	12	0.8	MKP1848612704K2	20	70
	35.5	10	1.0	MKP1848610704P*	34	105
	35.5	12	1.0	MKP1848612704P*	32	105
	35.5	15	1.0	MKP1848615704P*	30	105
	38.5	20	1.0	MKP1848620704P*	36	91
	44	22	1.0	MKP1848622704P*	49	77
	44	25	1.0	MKP1848625704P*	47	77
	45	30	1.0	MKP1848630704P*	62	63
	45	35	1.0	MKP1848635704P*	55	63
	45	30	1.2	MKP1848630704Y*	76	55
	45	35	1.2	MKP1848635704Y*	71	55
	45	40	1.2	MKP1848640704Y*	66	55
	45	45	1.2	MKP1848645704Y*	95	45
	45	50	1.2	MKP1848650704Y*	88	45
	50	55	1.2	MKP1848655704Y*	112	40
	50	60	1.2	MKP1848660704Y*	107	40
	50	65	1.2	MKP1848665704Y*	100	40
45	70	1.2	MKP1848670704Y5	128	30	
45	75	1.2	MKP1848675704Y5	123	30	
45	80	1.2	MKP1848680704Y5	119	30	
65	160	1.2	MKP1848716704Y5 ⁽³⁾	264	20	
65	320	1.2	MKP1848732704Y5 ⁽⁴⁾	359	10	
800	U_{OPDC} AT 70 °C = 900 V, U_{OPDC} AT 105 °C = 570 V					
	19	1	0.8	MKP1848510084K2	6.5	160
	21	2	0.8	MKP1848520084K2	9	130
	23	3	0.8	MKP1848530084K2	11	115
	25	4	0.8	MKP1848540084K2	12	100
	28	5	0.8	MKP1848550084K2	17	80
	28	6	0.8	MKP1848560084K2	16	80
	31	7	0.8	MKP1848570084K2	23	65
	31	8	0.8	MKP1848580084K2	21	65
	35	9	0.8	MKP1848590084K2	21	70
	35.5	10	1.0	MKP1848610084P*	32	105
	35.5	12	1.0	MKP1848612084P*	30	105
	38.5	15	1.0	MKP1848615084P*	37	91
	44	20	1.0	MKP1848620084P*	47	77
	45	22	1.0	MKP1848622084P*	65	63
	45	25	1.0	MKP1848625084P*	61	63
	45	30	1.2	MKP1848630084Y*	69	55
	45	35	1.2	MKP1848635084Y*	97	45



PACKAGING INFORMATION						
U _{NDC} AT 85 °C (V)	HEIGHT (mm)	CAP. ⁽⁵⁾ (µF)	Ø dt	ORDERING CODE ⁽¹⁾	MASS (g)	SPQ ⁽²⁾ (pcs)
800	U_{OPDC} AT 70 °C = 900 V, U_{OPDC} AT 105 °C = 570 V					
	45	40	1.2	MKP1848640084Y*	91	45
	50	45	1.2	MKP1848645084Y*	112	40
	50	50	1.2	MKP1848650084Y*	104	40
	45	55	1.2	MKP1848655084Y5	131	30
	45	60	1.2	MKP1848660084Y5	125	30
	65	120	1.2	MKP1848712084Y5 ⁽³⁾	276	20
	65	240	1.2	MKP1848724084Y5 ⁽⁴⁾	393	10
900	U_{OPDC} AT 70 °C = 1100 V, U_{OPDC} AT 105 °C = 650 V					
	19	1	0.8	MKP1848510094K2	6	160
	23	2	0.8	MKP1848520094K2	11	115
	25	3	0.8	MKP1848530094K2	12	100
	28	4	0.8	MKP1848540094K2	16.5	80
	31	5	0.8	MKP1848550094K2	22.5	65
	31	6	0.8	MKP1848560094K2	21	65
	35	7	0.8	MKP1848570094K2	21	70
	35.5	5	1.0	MKP1848550094P*	32	105
	35.5	6	1.0	MKP1848560094P*	30	105
	35.5	7	1.0	MKP1848570094P*	33	105
	35.5	8	1.0	MKP1848580094P*	31	105
	35.5	9	1.0	MKP1848590094P*	30	105
	38.5	10	1.0	MKP1848610094P*	39	91
	38.5	12	1.0	MKP1848612094P*	36	91
	44	15	1.0	MKP1848615094P*	47	77
	44	16	1.0	MKP1848616094P*	45	77
	45	20	1.0	MKP1848620094P*	57	63
	45	15	1.2	MKP1848615094Y*	70	55
	45	20	1.2	MKP1848620094Y*	73	55
	45	22	1.2	MKP1848622094Y*	70	55
	45	25	1.2	MKP1848625094Y*	98	45
	45	30	1.2	MKP1848630094Y*	89	45
50	35	1.2	MKP1848635094Y*	109	40	
50	40	1.2	MKP1848640094Y*	99	40	
45	45	1.2	MKP1848645094Y5	124	30	
45	50	1.2	MKP1848650094Y5	117	30	
65	100	1.2	MKP1848710094Y5 ⁽³⁾	259	20	
65	200	1.2	MKP1848720094Y5 ⁽⁴⁾	608	10	
1100	U_{OPDC} AT 70 °C = 1350 V, U_{OPDC} AT 105 °C = 800 V					
	21	1	0.8	MKP1848510914K2	9	130
	25	2	0.8	MKP1848520914K2	12	100
	28	3	0.8	MKP1848530914K2	16	80
	31	4	0.8	MKP1848540914K2	21.5	65
	35.5	5	1.0	MKP1848550914P*	33	105



PACKAGING INFORMATION						
U _{NDC} AT 85 °C (V)	HEIGHT (mm)	CAP. ⁽⁵⁾ (µF)	Ø dt	ORDERING CODE ⁽¹⁾	MASS (g)	SPQ ⁽²⁾ (pcs)
1100	U_{OPDC} AT 70 °C = 1350 V, U_{OPDC} AT 105 °C = 800 V					
	35.5	6	1.0	MKP1848560914P*	30	105
	38.5	7	1.0	MKP1848570914P*	39	91
	38.5	8	1.0	MKP1848580914P*	37	91
	44	9	1.0	MKP1848590914P*	50	77
	44	10	1.0	MKP1848610914P*	48	77
	45	12	1.0	MKP1848612914P*	63	63
	45	10	1.2	MKP1848610914Y*	81	55
	45	12	1.2	MKP1848612914Y*	77	55
	45	15	1.2	MKP1848615914Y*	70	55
	45	20	1.2	MKP1848620914Y*	91	45
	50	22	1.2	MKP1848622914Y*	115	40
	50	25	1.2	MKP1848625914Y*	108	40
	45	30	1.2	MKP1848630914Y5	126	30
	65	60	1.2	MKP1848660914Y5 ⁽³⁾	256	20
	65	70	1.2	MKP1848670914Y5 ⁽³⁾	257	20
65	120	1.2	MKP1848712914Y5 ⁽⁴⁾	606	10	
65	140	1.2	MKP1848714914Y5 ⁽⁴⁾	608	10	
1200	U_{OPDC} AT 70 °C = 1500 V, U_{OPDC} AT 105 °C = 850 V					
	21	1	0.8	MKP1848510924K2	9	130
	25	2	0.8	MKP1848520924K2	11.5	100
	28	3	0.8	MKP1848530924K2	15	80
	31	4	0.8	MKP1848540924K2	20	65
	35.5	5	1.0	MKP1848550924P*	31	105
	35.5	6	1.0	MKP1848560924P*	29	105
	38.5	7	1.0	MKP1848570924P*	37	91
	38.5	8	1.0	MKP1848580924P*	35	91
	44	9	1.0	MKP1848590924P*	48	77
	44	10	1.0	MKP1848610924P*	45	77
	45	12	1.0	MKP1848612924P*	60	63
	45	10	1.2	MKP1848610924Y*	79	55
	45	12	1.2	MKP1848612924Y*	74	55
	45	15	1.2	MKP1848615924Y*	67	55
	50	20	1.2	MKP1848620924Y*	115	40
	50	22	1.2	MKP1848622924Y*	109	40
	50	25	1.2	MKP1848625924Y*	100	40
	45	30	1.2	MKP1848630924Y5	119	30
65	60	1.2	MKP1848660924Y5 ⁽³⁾	264	20	
65	120	1.2	MKP1848712924Y5 ⁽⁴⁾	612	10	

Notes

- (1) Change the * symbol with special code for the terminals
- (2) SPQ = Standard Packing Quantity
- (3) 6 pins
- (4) 12 pins
- (5) Intermediate capacitance values available on request

CONSTRUCTION DESCRIPTION

Low inductive wound cell elements of metallized polypropylene film, potted with resin in a flame retardant case.

Specific Method of Mounting to Withstand Vibration and Shock

The capacitor unit is designed for mounting on a printed circuit board.

In order to withstand vibration and shock tests, it must be insured that the stand-off pips are in good contact with the printed circuit board.

The capacitors shall be mechanically fixed by the leads and the body clamped.

Space Requirements on Printed-Circuit Board

The maximum length and width of film capacitors is shown in the figure:

- Product height with seating plane as given by "IEC 60717" as reference:

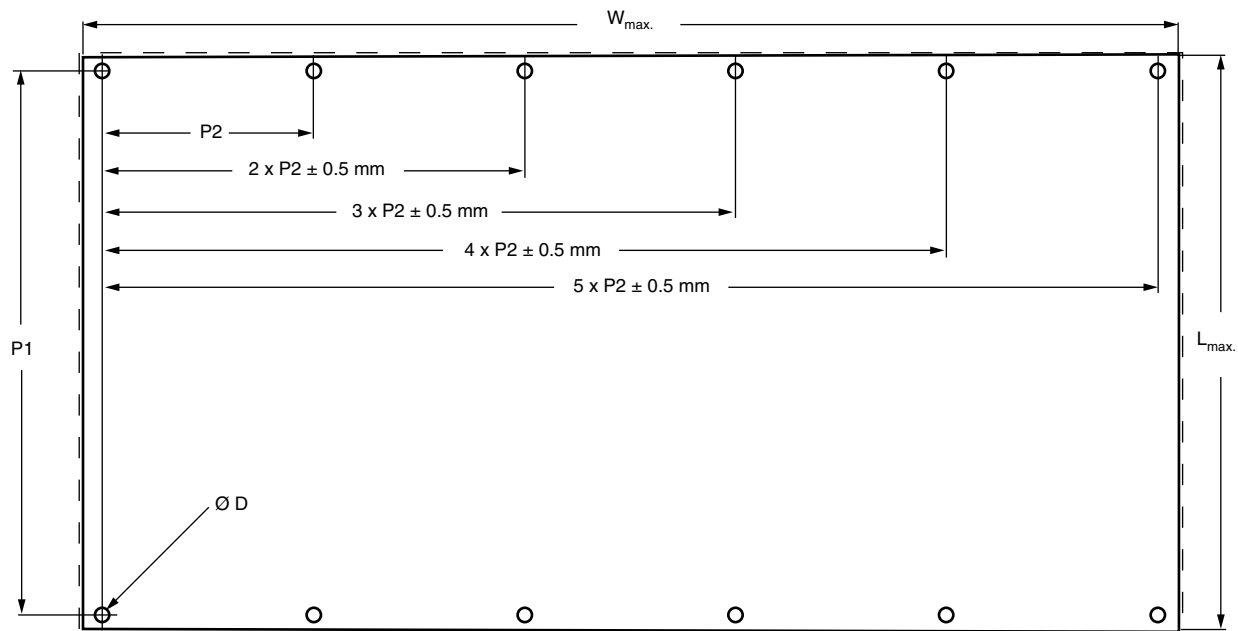

P1 (mm)	L _{max.} (mm)	W _{max.} (mm)	Ø D (mm)	H (mm)
27.5	l + 1.6	w + 2.0	1.2	h + 0.2
37.5	l + 2.0	w + 3.0	1.5	h + 0.5
52.5	l + 2.4	w + 4.0	1.7	h + 0.5

SOLDERING CONDITIONS

For general soldering conditions and wave soldering profile, we refer to the application note:

"Soldering Guidelines for Film Capacitors": www.vishay.com/doc?28171

Storage Temperature

T_{stg} = - 25 °C to + 35 °C with RH maximum 75 % without condensation.

Ratings and Characteristics Reference Conditions

Unless otherwise specified, all electrical values apply to an ambient temperature of 23 °C ± 1 °C, an atmospheric pressure of 86 kPa to 106 kPa and a relative humidity of 50 % ± 2 %.

For reference testing, a conditioning period shall be applied over 96 h ± 4 h by heating the products in a circulating air oven at the rated temperature and a relative humidity not exceeding 20 %.



CHARACTERISTICS

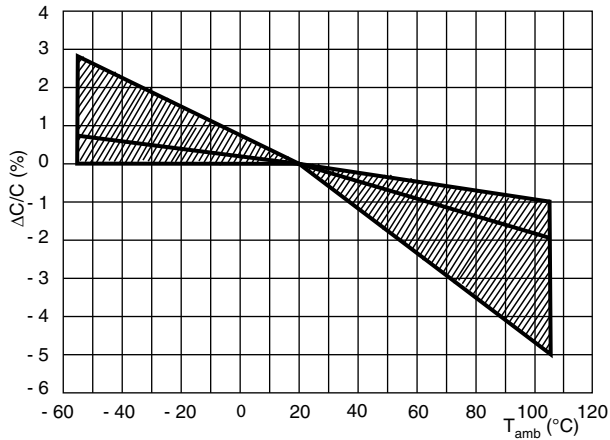

Capacitance (typical curve)

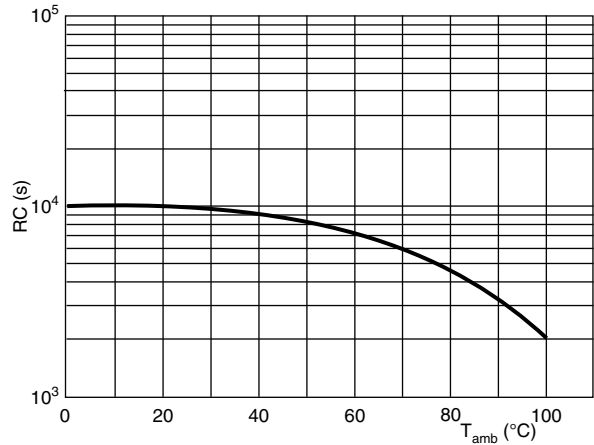

Insulation resistance (typical curve)

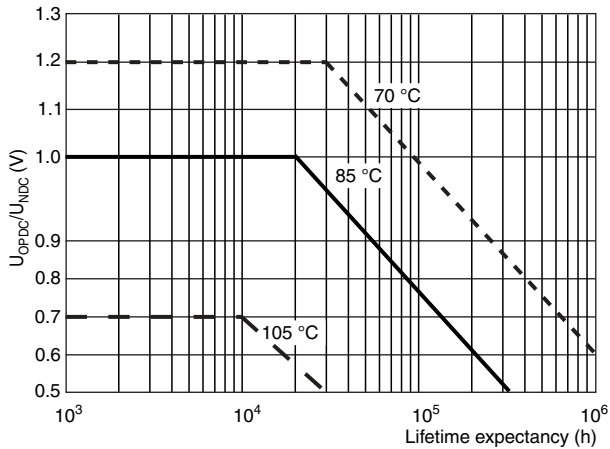

Lifetime expectancy (typical curve)

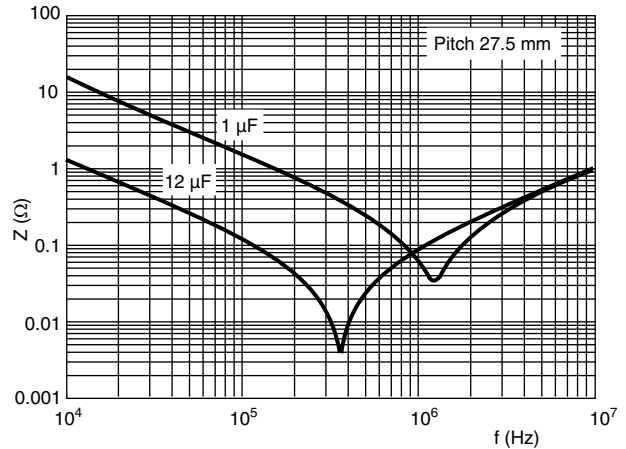

Impedance vs. frequency (typical curve)

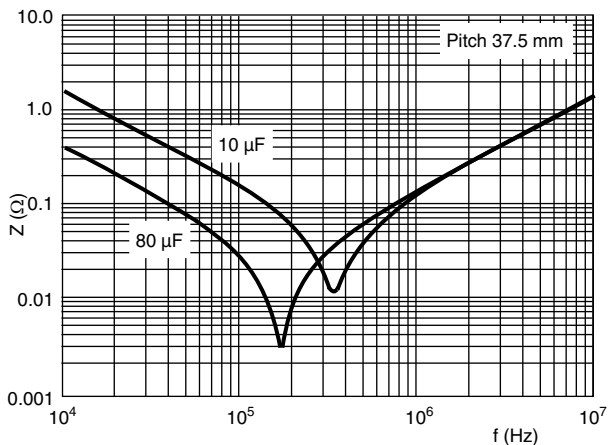

Impedance vs. frequency (typical curve)

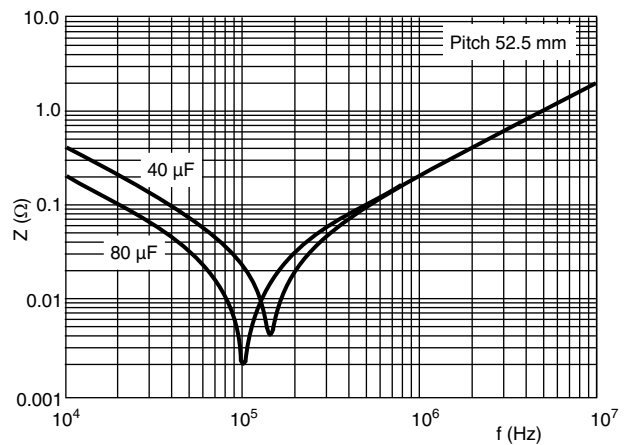

Impedance vs. frequency (typical curve)

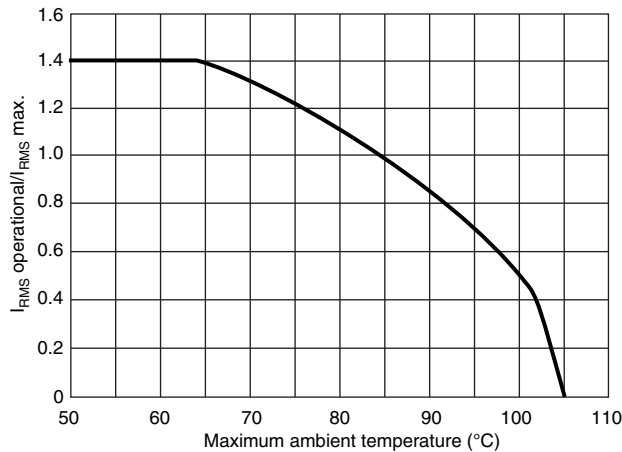

Maximum I_{RMS} current in function of the ambient temperature

HEAT CONDUCTIVITY			
DIMENSIONS (mm)			HEAT CONDUCTIVITY (mW/°C)
w	h	l	
9.0	19.0	32.0	24
11.0	21.0	32.0	28
13.0	23.0	32.0	32
15.0	25.0	32.0	36
18.0	28.0	32.0	44
21.0	31.0	32.0	51
21.0	35.0	32.0	56
18.5	35.5	43.0	54
21.5	38.5	43.0	61
24.0	44.0	42.0	70
30.0	45.0	42.0	81
25.0	45.0	57.5	77
30.0	45.0	57.5	85
35.0	50.0	57.5	100
45.0	45.0	57.5	94
70.0	65.0	57.5	152
130.0	65.0	57.5	243

POWER DISSIPATION AND MAXIMUM COMPONENT TEMPERATURE RISE

The power dissipation must be limited in order not to exceed the maximum allowed component temperature rise as a function of the free air ambient temperature.

The component temperature rise (ΔT) can be measured or calculated by $\Delta T = P/G$:

- $\Delta T = T_C - T_{amb}$ = Case temperature rise (°C) with a maximum of 15 °C at rated temperature.
- $P = I_{RMS}^2 \times ESR$ = Power dissipation of the component (mW)
- G = Heat conductivity of the component (mW/°C)

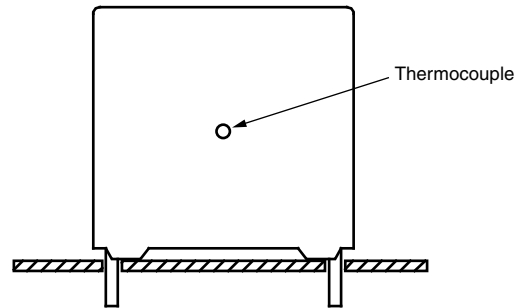
MEASURING THE COMPONENT TEMPERATURE

The case temperature is measured in unloaded (T_{amb}) and maximum loaded condition (T_C). To avoid thermal radiation or convection, the capacitor must be tested in a closed area from air circulation.

APPLICATION NOTE AND LIMITING CONDITIONS

These capacitors are not suitable for mains applications as across-the-line capacitors without additional protection. These mains applications are strictly regulated in safety standards and therefore electromagnetic interference suppression capacitors conforming the standards must be used.

To select the capacitor for a certain application, the following conditions must be checked:

- The continuous peak voltage (U_{P+}) shall not exceed the rated DC voltage rating (U_{NDC})
- The peak-to-peak ripple voltage (U_{PP}) shall not be greater than $0.2 \times (U_{NDC})$

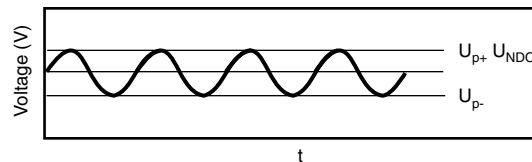
Non reversing recurrent waveform

- For capacitors connected in parallel, normally the proof voltage and possibly the rated voltage must be reduced. For information depending of the capacitance value and the number of parallel connections contact: dc-film@vishay.com
- The voltage peak slope (dU/dt) shall not exceed the pulse slope at the DC voltage rating. If the pulse voltage is lower than the rated DC voltage, the rated voltage pulse slope may be multiplied by U_{NDC} and divided by the applied voltage.

For all other pulses following equation must be fulfilled:

$$2 \times \int_0^T \left(\frac{dU}{dt} \right)^2 \times dt < U_{NDC} \times \left(\frac{dU}{dt} \right)_{rated}$$

T is the pulse duration

Maximum Repetitive Peak Voltages

The capacitor unit may be subjected to the following surge without any significant reduction of lifetime expectancy

REPETITIVE SURGE VOLTAGE	MAXIMUM DURATION PER DAY
$1.1 \times U_{NDC}$	30 % on load duration
$1.15 \times U_{NDC}$	30 min
$1.2 \times U_{NDC}$	5 min
$1.3 \times U_{NDC}$	1 min
$1.5 \times U_{NDC}$	110 ms



INSPECTION REQUIREMENTS

General Notes

Sub-clause numbers of tests and performance requirements refer to the “Sectional Specification, Publication IEC 61071”.

SUB-CLAUSE NUMBER AND TEST	CONDITIONS	PERFORMANCE REQUIREMENTS
ROUTINE TEST-FINAL INSPECTION		
5.14.2.1 External inspection, visual examination		Legible marking as specified
5.14.2.2 Dimensions		See specification drawing
5.3.1 Capacitance	1 kHz at room temperature	See specific reference data
5.3.2 tan δ	1 kHz at room temperature 10 kHz at room temperature	See specific reference data
5.5.1.2 Voltage test between terminal	1.5 x U _{NDC} at T _{amb} Duration 10 s	No visible damage or puncture No flashover
5.7 Insulation resistance	U _{NDC} ≤ 500 V measuring voltage 100 V at room temperature U _{NDC} > 500 V measuring voltage 500 V at room temperature Duration 1 min	See specific reference data
TYPE TESTS		
5.14.2 External inspection	Check for finish, marking and overall dimensions	Legible marking and finish as specified Dimensions: See specific drawing
5.14.0 Initial measurements	Capacitance at 1 kHz tan δ at 10 kHz	
5.14.1.1.4 Robustness of terminations IEC 60068-2-21	Tensile U _{a1} Wire diameter section load ≤ 0.8 mm ≤ 0.5 mm ² 10 N ≤ 1.25 mm ≤ 1.2 mm ² 20 N Duration 10 s ± 1 s Bending U _b method 1 Wire diameter section load ≤ 0.8 mm ≤ 0.05 mm ³ 10 N ≤ 1.25 mm ≤ 0.019 mm ³ 20 N 4 x 90 °, Duration 2 s to 3 s/bend	
5.14.1.6 Resistance to soldering heat IEC 60068-2-20	No predrying, Method 1A Solder bath: 260 °C Duration 10 s ± 1 s	
5.14.4 Final measurements	Capacitance tan δ	$\Delta C/C$ ≤ 0.5 % Increase of tan δ ≤ 0.0050 Compared to values measured in 5.14.0
5.14.0 Initial measurements	Capacitance at 1 kHz tan δ at 10 kHz	



SUB-CLAUSE NUMBER AND TEST	CONDITIONS	PERFORMANCE REQUIREMENTS
TYPE TESTS		
5.14.3.1 Vibration IEC 60068-2-6	10 Hz to 55 Hz: Amplitude ± 0.35 mm or acceleration 98 m/s ² Test duration: 10 frequency cycles, 3 axes offset from each other by 90° 1 octave/min Visual examination	No visible damages
5.14.3.2 Shock or impact IEC 60068-2-6	Pulse shape: Half sine Acceleration: 490 m/s ² Duration t of pulse: 11 ms Visual examination	No visible damage
5.14.4 Final measurements	Capacitance tan δ	$ \Delta C/C \leq 0.5 \%$ Increase of tan $\delta \leq 0.0050$ Compared to values measured in 5.14.0
5.5.3.1 Initial measurements	Capacitance at 1 kHz tan δ at 10 kHz R insulation	
5.5.3.2 Voltage test between terminal	$1.5 \times U_{NDC}$ at T_{amb} Duration 60 s	
5.5.3.3 Final measurements	Capacitance tan δ R insulation	
5.9.1 Initial measurements	Capacitance at 1 kHz tan δ at 10 kHz	
5.9.2 Surge discharge test	$1.1 \times U_{NDC}$ Number of discharges: 5 Time lapse: Every 2 min (10 min total)	
5.9.3 Voltage test between terminal	Within 5 min after the surge discharge test Duration 60 s $1.5 \times U_{NDC}$ at T_{amb}	
5.9.3 Final measurements	Capacitance tan δ at 10 kHz	
5.11.1 Initial measurements	Capacitance at 1 kHz tan δ at 10 kHz	
5.11.2 Self healing test	$1.5 \times U_{NDC}$ Duration 10 s Number of clearings ≤ 5 Clearing = Voltage drop of 5 % increase the voltage at 100 V/s till 5 clearings occur with a max. of $2.5 \times U_{NDC}$ for a duration of 10 s	
5.11.3 Final measurements	Capacitance tan δ	



SUB-CLAUSE NUMBER AND TEST	CONDITIONS	PERFORMANCE REQUIREMENTS
TYPE TESTS		
5.13.0 Initial measurements	Capacitance at 1 kHz tan δ at 10 kHz	
5.13.1 Change of temperature acc. to IEC 60068-2-14	Test Nb $T_{max.} = 85\text{ }^{\circ}\text{C}$ $T_{min.} = -40\text{ }^{\circ}\text{C}$ Transition time: 1 h, equivalent to $1\text{ }^{\circ}\text{C}/\text{min}$	
5.13.2 Damp heat steady state acc. to IEC 60068-2-78	Test Ca $T_{max.} = 40\text{ }^{\circ}\text{C} \pm 2\text{ }^{\circ}\text{C}$ RH = $93\% \pm 3\%$ Duration 56 days	
5.5.3.2 Voltage test between terminal	$1.5 \times U_{NDC}$ at ambient temperature Duration 60 s	
5.13.3 Final measurements	Visual examination Capacitance tan δ at $1 U_{RMS}$ 10 kHz	No puncturing or flashover Self healing punctures are permitted $ \Delta C/C \leq 2.0\%$ Increase of tan $\delta \leq 0.0150$ Compared to values measured in 5.13.0
5.10.0 Initial measurements	Capacitance at 1 kHz tan δ at 10 kHz	
5.10.1 Thermal stability test under overload conditions	Natural cooling $T_{amb} \pm 5\text{ }^{\circ}\text{C}$ $1.21 \times P_{max.} = (U_2/2) \times W_2 \times C \times \tan \delta =$ $121 \times (I_{max.}^2/W_2 \times c) \times \tan \delta_2$ with $W_2 = 2 \times p \times f_2$ for $I_{max.}$ (see specific reference data) $f_2 = 10\text{ kHz}$ Duration 48 h	
5.10.2 Final measurements	Measure the temperature every 1.5 h during the last 6 h Capacitance tan δ at 10 kHz	Temperature rise $< 1\text{ }^{\circ}\text{C}$ $ \Delta C/C \leq 2\%$ Increase of tan $\delta \leq 1.2 \times \text{initial } \delta + 0.0150$
5.12 Resonance frequency measurement	Impedance analyser at T_{amb}	< 0.9 times the value as specified in typical curve "Resonant frequency" of this specification
5.10.0 Initial measurements	Capacitance at 1 kHz tan δ at 10 kHz	
5.15.1 Endurance test between terminals	Sequence $1.4 \times U_{NDC}$ at $T_{max.} = 85\text{ }^{\circ}\text{C}$ $1.4 \times U_{OPDC}$ at $105\text{ }^{\circ}\text{C}$ Duration 250 h 1000 x discharge at $1.4 \times I$ (maximum repetitive peak current in continuous operation) $1.4 \times U_{NDC}$ at $T_{max.} = 85\text{ }^{\circ}\text{C}$ $1.4 \times U_{OPDC}$ at $105\text{ }^{\circ}\text{C}$ Duration 250 h	
5.15.2 Final measurements	Capacitance tan δ	$ \Delta C/C \leq 3\%$ Increase of tan $\delta \leq 0.0150$ Compared to values measured in 5.15.0



SUB-CLAUSE NUMBER AND TEST	CONDITIONS	PERFORMANCE REQUIREMENTS
TYPE TESTS		
5.16.3.0 Initial measurements	Capacitance at 1 kHz at $T_{max.} = 85\text{ °C}$	
5.16.3.1 Destruction test sequence High DC voltage test	Product enveloped with chees cloth 3 x U_{NDC} or DC voltage Until repetitive product healings occur Duration = 15 min	Audible healings or check healings with oscilloscope
High AC voltage test	AC_{RMS} voltage = $U_{NDC} \times 2 \sqrt{2}$ with minimum of 250 V_{AC} Duration = 5 min Repeat destruction sequence 3 x	
5.16.3.2 Final measurements	Visual examination	No puncturing or flashover Self healing punctures are permitted



Disclaimer

ALL PRODUCT, PRODUCT SPECIFICATIONS AND DATA ARE SUBJECT TO CHANGE WITHOUT NOTICE TO IMPROVE RELIABILITY, FUNCTION OR DESIGN OR OTHERWISE.

Vishay Intertechnology, Inc., its affiliates, agents, and employees, and all persons acting on its or their behalf (collectively, "Vishay"), disclaim any and all liability for any errors, inaccuracies or incompleteness contained in any datasheet or in any other disclosure relating to any product.

Vishay makes no warranty, representation or guarantee regarding the suitability of the products for any particular purpose or the continuing production of any product. To the maximum extent permitted by applicable law, Vishay disclaims (i) any and all liability arising out of the application or use of any product, (ii) any and all liability, including without limitation special, consequential or incidental damages, and (iii) any and all implied warranties, including warranties of fitness for particular purpose, non-infringement and merchantability.

Statements regarding the suitability of products for certain types of applications are based on Vishay's knowledge of typical requirements that are often placed on Vishay products in generic applications. Such statements are not binding statements about the suitability of products for a particular application. It is the customer's responsibility to validate that a particular product with the properties described in the product specification is suitable for use in a particular application. Parameters provided in datasheets and/or specifications may vary in different applications and performance may vary over time. All operating parameters, including typical parameters, must be validated for each customer application by the customer's technical experts. Product specifications do not expand or otherwise modify Vishay's terms and conditions of purchase, including but not limited to the warranty expressed therein.

Except as expressly indicated in writing, Vishay products are not designed for use in medical, life-saving, or life-sustaining applications or for any other application in which the failure of the Vishay product could result in personal injury or death. Customers using or selling Vishay products not expressly indicated for use in such applications do so at their own risk. Please contact authorized Vishay personnel to obtain written terms and conditions regarding products designed for such applications.

No license, express or implied, by estoppel or otherwise, to any intellectual property rights is granted by this document or by any conduct of Vishay. Product names and markings noted herein may be trademarks of their respective owners.

Material Category Policy

Vishay Intertechnology, Inc. hereby certifies that all its products that are identified as RoHS-Compliant fulfill the definitions and restrictions defined under Directive 2011/65/EU of The European Parliament and of the Council of June 8, 2011 on the restriction of the use of certain hazardous substances in electrical and electronic equipment (EEE) - recast, unless otherwise specified as non-compliant.

Please note that some Vishay documentation may still make reference to RoHS Directive 2002/95/EC. We confirm that all the products identified as being compliant to Directive 2002/95/EC conform to Directive 2011/65/EU.

Vishay Intertechnology, Inc. hereby certifies that all its products that are identified as Halogen-Free follow Halogen-Free requirements as per JEDEC JS709A standards. Please note that some Vishay documentation may still make reference to the IEC 61249-2-21 definition. We confirm that all the products identified as being compliant to IEC 61249-2-21 conform to JEDEC JS709A standards.