

## Datasheet

### 24 way cable mount plug

RS Stock number [239-1207](#)

Dimensions: (mm)

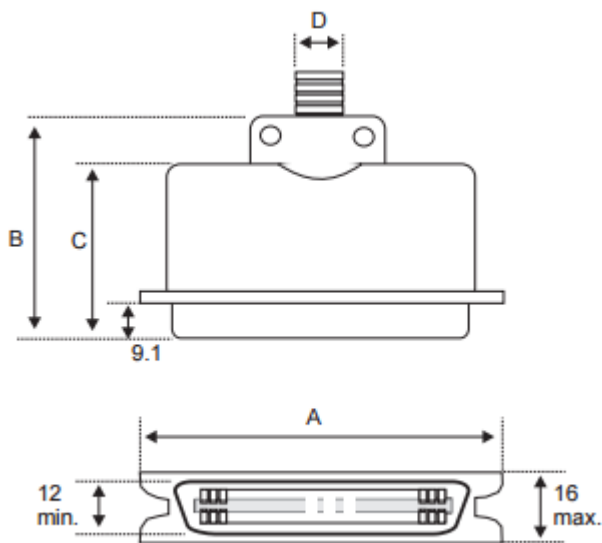

## Specifications

- Number of contacts: 14,24,36,50
- Current Rating: 5 Amp
- Dielectric Strength: 1000 V for 1 minute
- Insulation Resistance: 1000 M  $\Omega$  min ( at 500 V DC)
- Temperature: -55°C to +105°C
- Material and Finish:
  - Shell: Steel, Nickel Plated
  - Socket Contact: Phosphor Bronze / Gold plated over Nickel
  - Insulator: PBT and glass-fibre reinforced UL-94-VO