

ZXRE4041

SOT23 MICROPOWER 1.225V VOLTAGE REFERENCE

SUMMARY

DESCRIPTION

The ZXRE4041 is a bandgap circuit designed to achieve a precision micropower voltage reference of 1.225 volts. The device is available in the small outline SOT23 surface mount package which is ideal for applications where space saving is important.

SOT23 tolerance is available to 0.5% C grade for precision applications. Excellent performance is maintained over the 30 μ A to 12mA operating current range with a typical temperature coefficient of only 20ppm/ $^{\circ}$ C. The device has been designed to be highly tolerant of capacitive loads so maintaining excellent stability.

This device offers a SOT23 pin for pin compatible alternative to LM4041 voltage references.

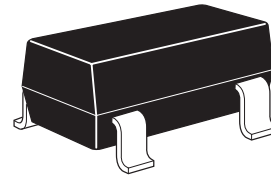

SOT23

FEATURES

- High performance alternative to LM4041
- Small outline SOT23
- 30 μ A knee current
- 20ppm/ $^{\circ}$ C typical temperature coefficient
- Unconditionally stable
- 0.5%, 1%, 2% and 3% tolerance

APPLICATIONS

- Battery powered equipment
- Precision power supplies
- Portable instrumentation
- Portable communications devices
- Notebook and palmtop computers
- Data acquisition systems
- A/D and D/A converters
- Test equipment

ORDERING INFORMATION

DEVICE	TOL%	GRADE	PACKAGE	PARTMARKING
ZXRE4041CF	0.5	C	SOT23	10J
ZXRE4041DF	1	D	SOT23	10H
ZXRE4041EF	2	E	SOT23	10G
ZXRE4041FF	3	F	SOT23	10F

NOTE:

For tape and reel options add suffix TA to part number - e.g. ZXRE4041DFTA

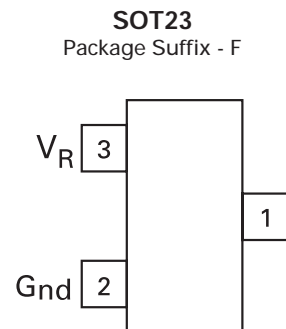

Top view -
Pin 1 floating or
connected to pin 2

ZXRE4041

ABSOLUTE MAXIMUM RATINGS

PARAMETER	SYMBOL	LIMIT	UNIT
Reverse current	V_Z	30	mA
Forward current		10	mA
Operating temperature	T_{OMP}	-40 to 125	°C
Storage temperature	T_{STG}	-55 to 125	°C

POWER DISSIPATION (at $T_{amb} = 25^{\circ}\text{C}$, $T_{jmax} = 25^{\circ}\text{C}$)

PACKAGE	VALUE	UNIT
SOT23	330	mW

ZXRE4041

SCHEMATIC DIAGRAM

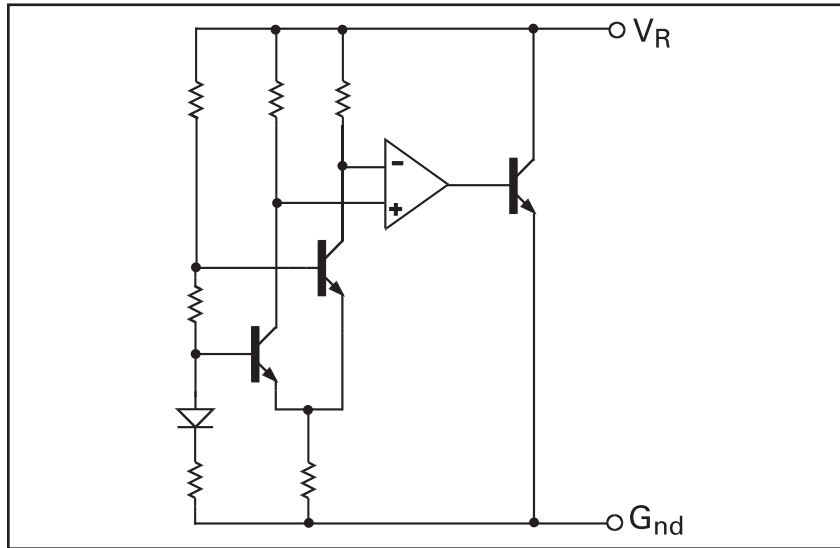

APPLICATIONS CIRCUIT

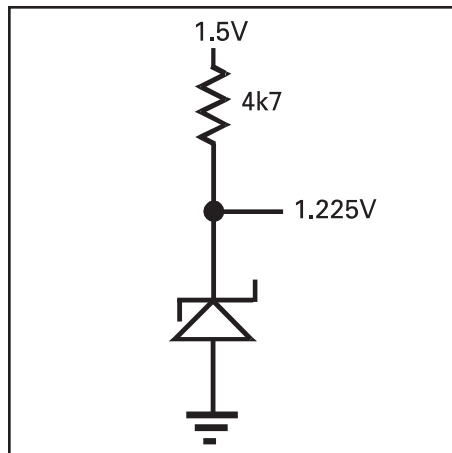

ZXRE4041

ELECTRICAL CHARACTERISTICS (at $T_{amb} = 25^{\circ}\text{C}$ unless otherwise stated)

PARAMETER	SYMBOL	CONDITIONS	MIN.	TYP.	MAX.	GRADE/ TOL%	UNITS
Reverse Breakdown Voltage	V_R	$I_R = 100\mu\text{A}$	1.219	1.225	1.231	C/0.5	V
			1.213	1.225	1.237	D/1	V
			1.200	1.225	1.250	E/2	V
			1.189	1.225	1.261	F/3	V
Minimum Knee Current	I_{MIN}			30		μA	
Recommended Operating Current Range	I_R		0.03	12		mA	
Average Reverse Breakdown Voltage Temperature Coefficient	$T_C^{(1)}$	$I_{R(min)}$ to $I_{R(max)}$		20	100		ppm/ $^{\circ}\text{C}$
Reverse Breakdown Change with Current Voltage	$\frac{\Delta V_R}{\Delta I_R}$	$I_R = 30\mu\text{A}$ to $1\mu\text{A}$ $I_R = 1\text{mA}$ to 12mA			1		mV
					10		mV
Reverse Dynamic Impedance	Z_R	$I_R = 1\text{mA}$ $f = 100\text{Hz}$ $I_{AC} = 0.1I_R$		0.2	0.6		Ω
Wideband Noise Voltage	E_N	$I_R = 8\mu\text{A}$ to $100\mu\text{A}$ $f = 10\text{Hz}$ to 10kHz		60			$\mu\text{V(rms)}$

NOTE:

$$(1) T_C = \frac{(V_{R(max)} - V_{R(min)}) \times 1000000}{V_R \times (T_{(max)} - T_{(min)})}$$

$V_{R(max)} - V_{R(min)}$ is the maximum deviation in reference voltage measured from -40°C to 85°C .

REVERSE CHARACTERISTICS

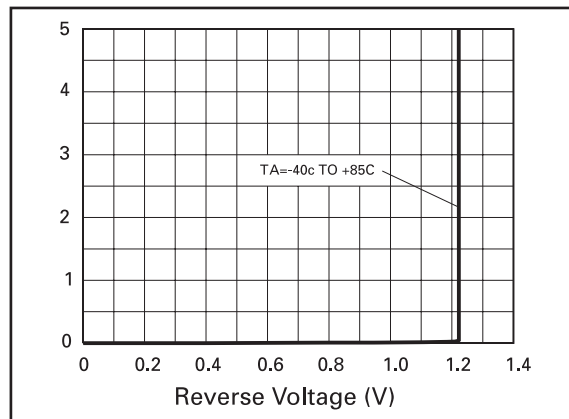

TYPICAL CHARACTERISTICS

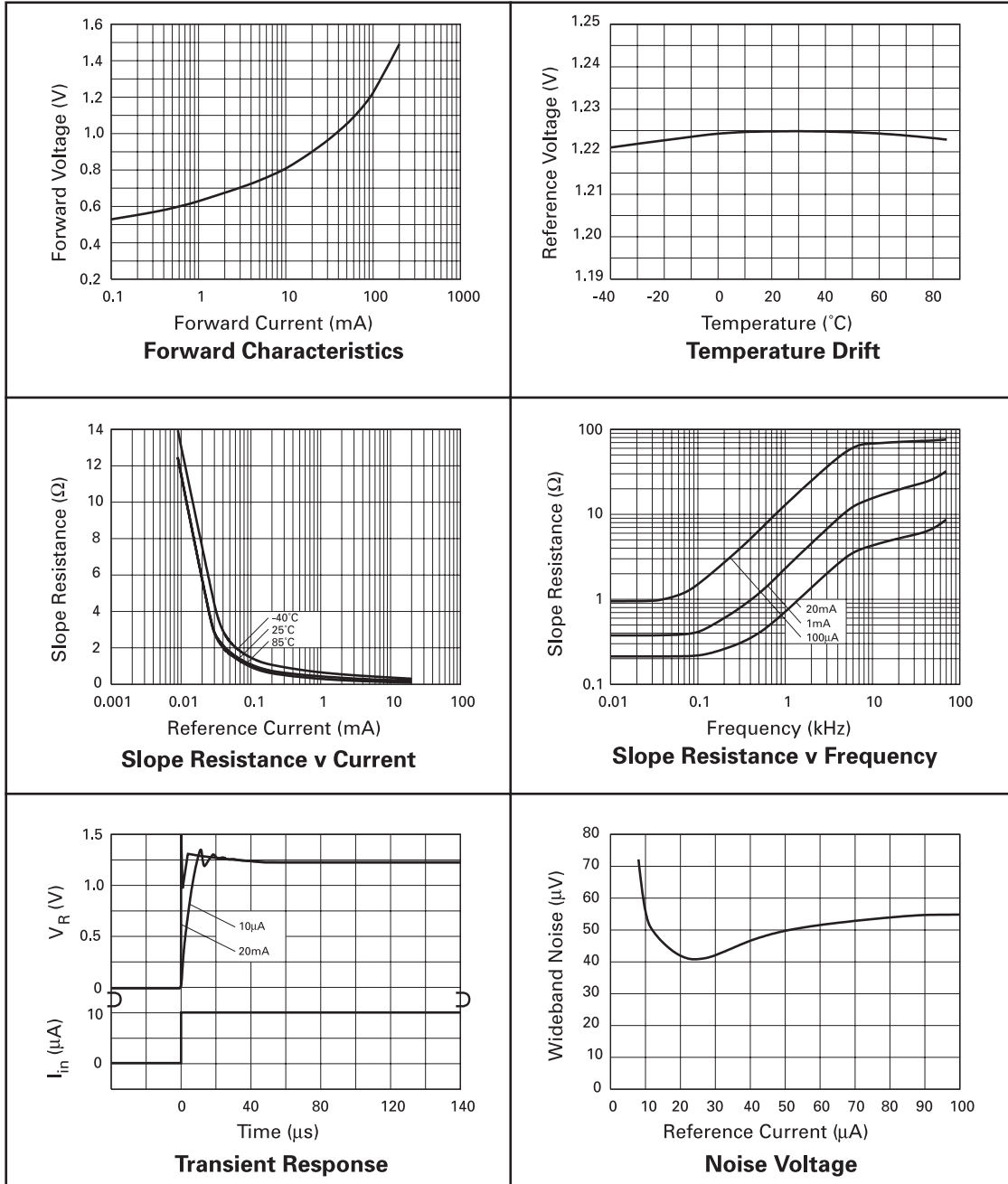

ZXRE4041

PACKAGE OUTLINE

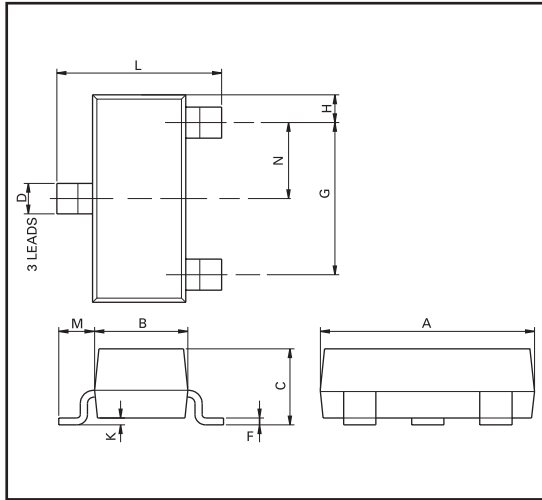

PAD LAYOUT

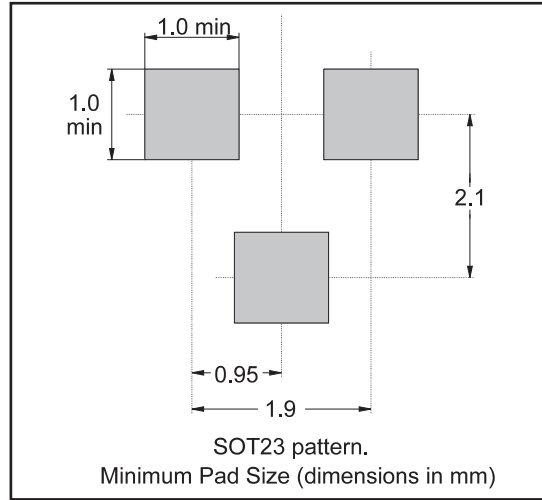

Controlling dimensions are in millimetres. Approximate conversions are given in inches

PACKAGE DIMENSIONS

DIM	Millimetres		Inches		DIM	Millimetres		Inches	
	Min	Max	Min	Max		Min	Max	Min	Max
A	2.67	3.05	0.105	0.120	G	NOM 1.9		NOM 0.037	
B	1.20	1.40	0.047	0.055	K	0.01	0.10	0.0004	0.004
C	-	1.10	-	0.043	L	2.10	2.50	0.083	0.0985
D	0.37	0.53	0.0145	0.021	N	NOM 0.95		NOM 0.037	
F	0.085	0.15	0.0033	0.0059					

© Zetex plc 2003

Europe	Americas	Asia Pacific
Zetex plc Fields New Road Chadderton Oldham, OL9 8NP United Kingdom Telephone (44) 161 622 4444 Fax: (44) 161 622 4446 hq@zetex.com	Zetex GmbH Streitfeldstraße 19 D-81673 München Germany Telefon: (49) 89 45 49 49 0 Fax: (49) 89 45 49 49 49 europe.sales@zetex.com	Zetex (Asia) Ltd 3701-04 Metroplaza Tower 1 Hing Fong Road Kwai Fong Hong Kong Telephone: (852) 26100 611 Fax: (852) 24250 494 asia.sales@zetex.com

These offices are supported by agents and distributors in major countries world-wide.

This publication is issued to provide outline information only which (unless agreed by the Company in writing) may not be used, applied or reproduced for any purpose or form part of any order or contract or be regarded as a representation relating to the products or services concerned. The Company reserves the right to alter without notice the specification, design, price or conditions of supply of any product or service.

For the latest product information, log on to www.zetex.com



ISSUE 5 - AUGUST 2003