

# FUSIBLE WIRE WOUND FIXED RESISTOR

## TYPE FWFU SERIES

### INTRODUCTION

TE Connectivity (TE)'s Fusible Wire Wound Fixed (FWFU) Resistor are a special type of resistor that also act as a safety fuse. They allow current to flow normally but break the circuit when the current exceeds a safe level, protecting electronic devices from damage. These resistors are commonly used in power supplies, chargers, and household appliances to help prevent overheating and short circuits. Unlike traditional fuses, they provide some resistance before they “blow,” making them useful for controlling inrush current.

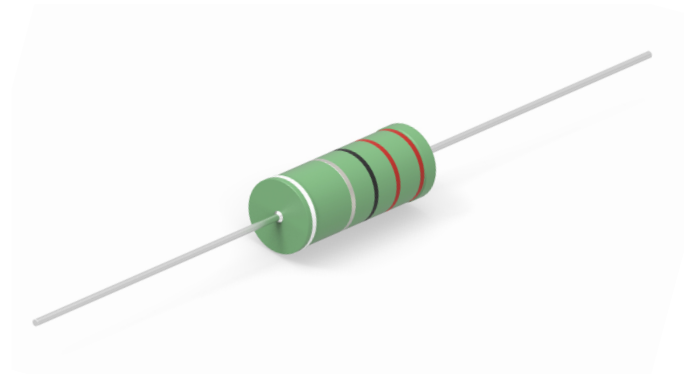

### FEATURES

- UL Approved (UL1412)\*
- Power up to 7 watts
- RoHS compliant with no exemptions
- Moisture sensitivity level-MSL1
- Flame resistant coating meets UL 94 V0 requirements
- Fusing time up to 120s

\*Estimated 15 July 2025

### APPLICATIONS

- LED lighting/LED Drivers
- EV chargers
- Power supply
- Test measurement equipment
- Surge protection and voltage divider
- Energy meter

### ELECTRICAL CHARACTERISTICS

Size	Standard Size					Small Size			
Type	FWFU 1W	FWFU 2W	FWFU 3W	FWFU 5W	FWFU 7W	FWFU 1WSS	FWFU 1WS	FWFU 2WS	FWFU 3WS
Rated Power @70°C Watts	1	2	3	5	7	1	1	2	3
Resistance tolerance	±5%								
Ohmic value Min (Ω)	R47					10R	R47		
Ohmic value Max (Ω)	240R				47R	-	240R		
Dielectric withstand Voltage	1000VAC								
Max working voltage	$RCWV = \sqrt{(P \times R)}$								
Max overload voltage	$2.5 \sqrt{(P \times R)}$								
Operating temperature	-55°C - 155°C								
Climatic category	55/155/42								
Net weight (mg)	630	990	1620	2590	3940	185	350	630	990

# Fusible Wire Wound Fixed Resistor

Type FWFU Series

## POWER RATING

Resistors shall have a power rating based on continuous full load operation at an ambient temperature of 70°C. For temperature in excess of 70°C, the load shall be derated as shown on the derating curve.

## VOLTAGE RATING

Resistors shall have a rated direct-current (DC) continuous working voltage or an approximate sine-wave root-mean-square (RMS) alternating-current (AC) continuous working voltage at commercial line frequency and waveform corresponding to the power rating, as determined from the following formula:

$$RCWV = \sqrt{P \times R}$$

Were: RCWV = Rated DC or RMS AC continuous working voltage at commercial-line frequency and waveform (volt)

P = Power Rating (watt)

R = Nominal Resistance (ohm)

In no case shall the rated DC or RMS AC continuous working voltage be greater than the applicable maximum value.

## DERATING CURVE

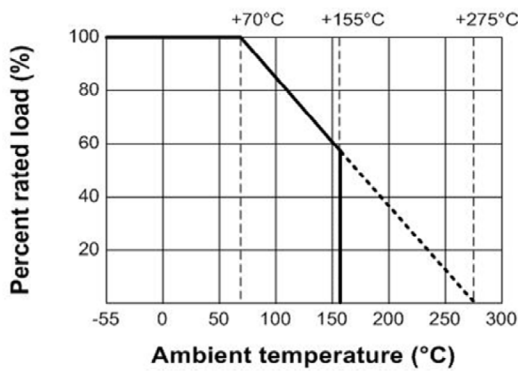

## HEAT RISE CHART

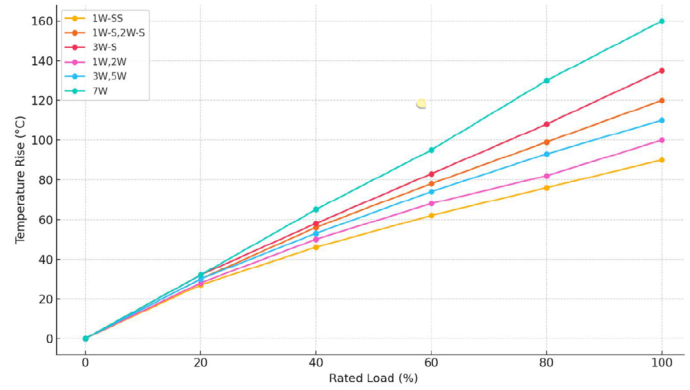

## THERMAL RESISTANCE

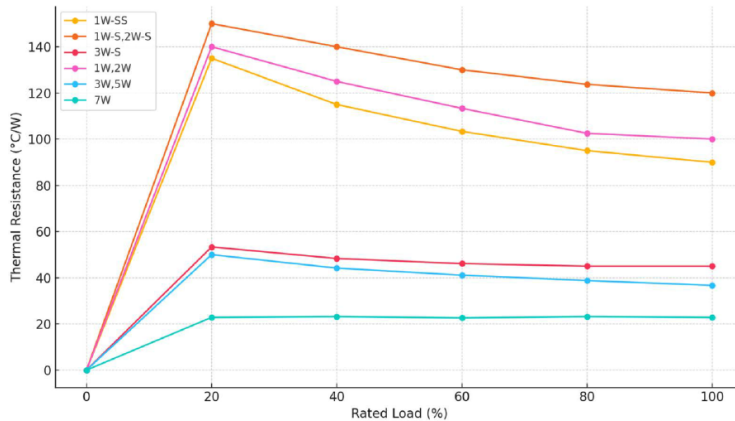

## FUSING GRAPH

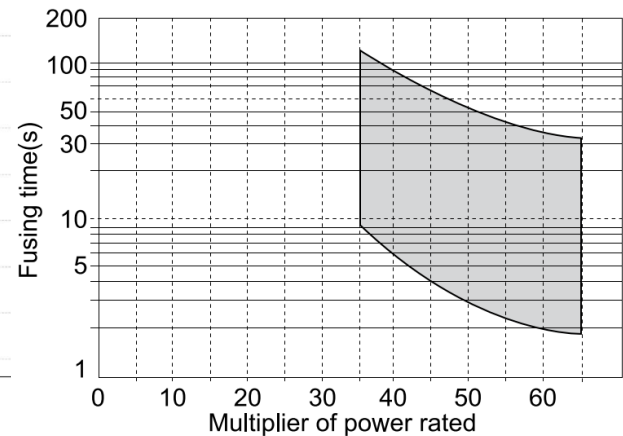

# Fusible Wire Wound Fixed Resistor

Type FWFU Series

## CONSTRUCTION

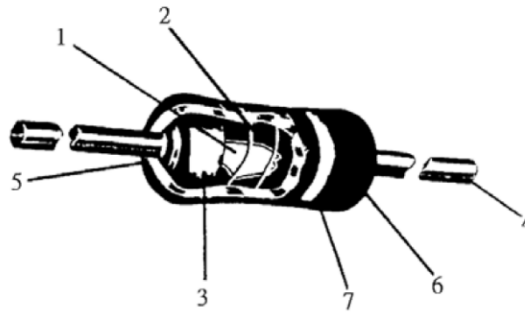

No.	Name	Material
1	Basic Body	Rod Type Ceramics
2	Resistance Wire	Resistance Wire Alloy
3	End Cap	Steel (tin plated iron surface)
4	Lead Wire	Annealed Copper wire with a tin matte finish
5	Connection	Lead wire to end cap attachment method: welded
6	Coating	Insulated and non-flame paint (colour: green)
7	Colour Code	Non-flame epoxy resin

## PERFORMANCE CHARACTERISTICS

Characteristics	Limits	Test Methods (JIS C 5201-1)
DC. Resistance	Must be within the specified tolerance	The limit of error of measuring apparatus shall not exceed allowable range or 5% of the resistance tolerance (Sub-clause 4.5)
Dielectric withstanding voltage	No evidence of flashover mechanical damage, arcing or insulation break down	Resistors shall be clamped in the trough of a 90° metallic V-block or foil method use a metal foil shall be wrapped closely around the body of the resistor. After that shall be tested at AC potential respectively specified in the electrical characteristic, for 60 +10/-0 secs. (Sub-clause 4.7)
Temperature coefficient	<20Ω : ± 400 PPM/°C ≥20Ω : ± 300 PPM/°C	Natural resistance change per temp. degree centigrade. $\frac{R2-R1}{R1(t2-t1)} \times 10^6$ (PPM/°C) R1 : Resistance value at room temperature (t1) R2 : Resistance value at room temperature plus 100°C (t2) (Sub-clause 4.8)
Short time overload	Resistance change rate is ± (2% + 0.05Ω) Max. with no evidence of mechanical damage	Permanent resistance change after the application of a potential of 2.5 times RCWV or Max. overload voltage, whichever is lesser for 5 seconds (Sub-clause 4.13)
Terminal strength	No evidence of mechanical damage	<b>Direct load:</b> Resistance to a 2.5kgs direct load for 10 secs. In the direction of the longitudinal axis of the terminal leads <b>Twist test:</b> Terminal leads shall be bent through 90° at a point of about 6mm from the body of the resistor and shall be rotated through 360° about the original axis of the bent terminal in alternating direction for a total of 3 rotations (Sub-clause 4.16)

# Fusible Wire Wound Fixed Resistor

Type FWFU Series

Characteristics	Limits	Test Methods (JIS C 5201-1)															
Solderability	95% coverage Min.	The area covered with a new, smooth, clean, shiny and continuous surface free from concentrated pinholes. Test temp. of solder : 245°C ±3°C Dwell time in solder : 2 ~ 3 seconds (Sub-clause 4.17)															
Soldering temp. reference	Electrical characteristics shall be satisfied. Without distinct deformation in appearance.  (95% coverage Min.)	The leads immersed into solder bath to 3.2 to 4.8mm. from the body. Permanent resistance change shall be checked. <b>Wave soldering condition: (2 cycles Max.)</b> Pre-heat : 100-120°C, 30±5 sec. Suggestion solder temp : 235-255°C, 10 sec. (Max.) Peak temp : 260°C <b>Hand soldering condition:</b> Hand soldering bit temp : 380±10°C Dwell time in solder : 3 +1/-0 sec.															
Resistance to soldering heat	Resistance change rate is ±(1%+0.05Ω) Max. with no evidence of mechanical damage	Permanent resistance change when leads immersed to 3.2mm to 4.8mm from the body in 350°C ± 10°C solder for 3 ± 0.5 seconds.(Sub-clause 4.18)															
Temperature cycling	Resistance change rate is ± (2% + 0.05Ω) Max. with no evidence of mechanical damage	Resistance change after continuous 100 cycles for duty shown below: <table border="1"> <thead> <tr> <th>Step</th> <th>Temperature</th> <th>Time</th> </tr> </thead> <tbody> <tr> <td>1</td> <td>-55°C±3°C</td> <td>30 mins</td> </tr> <tr> <td>2</td> <td>Room temp.</td> <td>10-15 mins</td> </tr> <tr> <td>3</td> <td>+155°C±2°C</td> <td>30 mins</td> </tr> <tr> <td>4</td> <td>Room temp.</td> <td>10-15 mins</td> </tr> </tbody> </table> (Sub-clause 4.19)	Step	Temperature	Time	1	-55°C±3°C	30 mins	2	Room temp.	10-15 mins	3	+155°C±2°C	30 mins	4	Room temp.	10-15 mins
Step	Temperature	Time															
1	-55°C±3°C	30 mins															
2	Room temp.	10-15 mins															
3	+155°C±2°C	30 mins															
4	Room temp.	10-15 mins															
Load life in humidity	Resistance change rate is ±(5% + 0.05Ω) Max. with no evidence of mechanical damage	Resistance change after 1,000 hours (1.5 hours “on”, 0.5 hour “off”) at RCWV in a humidity test chamber controlled at 40°C ± 2°C and 90 to 95% relative humidity (Sub-clause 4.24.2.1)															
Load life	Resistance change rate is ±(5% + 0.05Ω) Max. with no evidence of mechanical damage	Permanent resistance change after 1,000 hours operating at RCWV with duty cycle of (1.5 hours “on”, 0.5 “hour off”) at 70°C ± 2°C ambient (Sub-clause 4.25.1)															
Flammability	No ignition of the tissue paper or scorching of the pine wood board	V-0 or V-1 are acceptable. Electrical test not required (UL 94 rating)															
Fusing test	Resistance should be opened (The resistance value is over than 50 times from before test value) follow fusing curve condition <table border="1"> <thead> <tr> <th>Magnification of power</th> <th>Fusing</th> </tr> </thead> <tbody> <tr> <td>35 times</td> <td>120s (max)</td> </tr> </tbody> </table>	Magnification of power	Fusing	35 times	120s (max)	<p>Fusing curve</p>											
Magnification of power	Fusing																
35 times	120s (max)																

# Fusible Wire Wound Fixed Resistor

Type FWFU Series

## DIMENSIONS (Unit:mm)

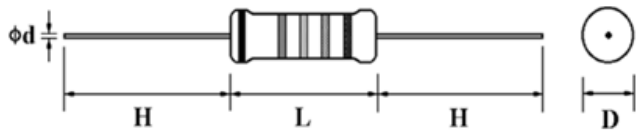

Type	D (Max)	L (Max)	d $\pm$ 0.05	H $\pm$ 3
FWFU 1W	5.0	12.0	0.70	28
FWFU 2W	5.5	16.0	0.70	28
FWFU 3W	6.5	17.5	0.75	28
FWFU 5W	8.0	20.0	0.75	38
FWFU 7W	8.5	25.0	0.75	38
FWFU 1WSS	3.0	8.5	0.54	28
FWFU 1WS	4.3	9.0	0.6	28
FWFU 2WS	5.0	12.0	0.7	28
FWFU 3WS	5.5	16.0	0.7	28

## PULSE LIMIT POWER

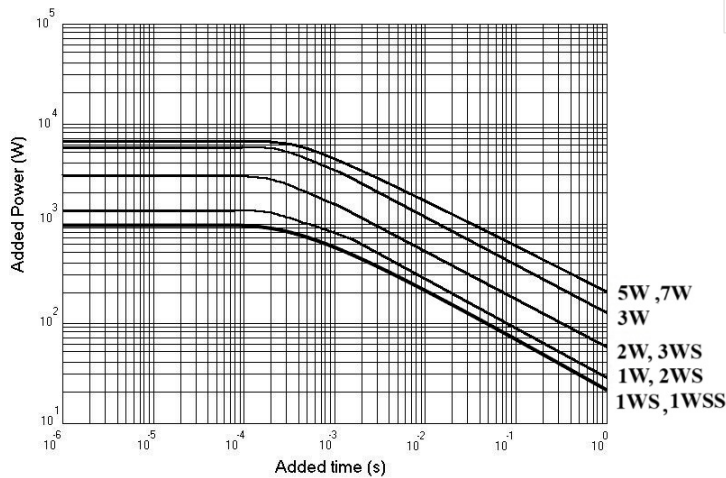

## PULSE CHARACTERISTICS (REPEAT)

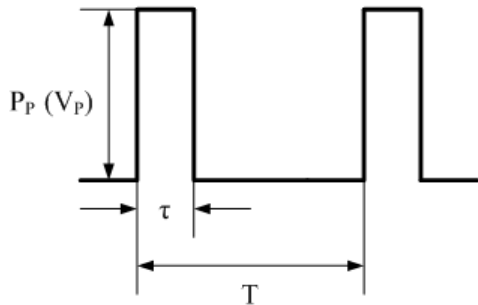

- $P_p$  : Pulse limit power (W)
- $V_p$  : Pulse limit voltage (V)
- $\tau$  : Pulse continuous times (s)
- $T$  : Period (s)
- $V_R$  : Rated voltage (V)
- $P$  : Rated power (W)
- $R$  : Nominal resistance ( $\Omega$ )
- $V_{p\max}$  : Max pulse limit voltage (V)

Withstand pulse limit power is calculated by the next method.

$$P_p = K \cdot P \cdot T / \tau$$

$$V_p = \sqrt{(K \cdot P \cdot R \cdot T / \tau)}$$

Reference to the right about a fixed number of  $V_{p\max}$

- $T > 1(s) \rightarrow T = 1(s)$
- $T / \tau > 100 \rightarrow T / \tau = 100$
- $P_p < P \rightarrow P$  stands for  $P_p$  ( $V_p < V_R \rightarrow V_R$  stands for  $V_p$ )
- Added voltage  $\leq V_{p\max}$
- $P_p$  or  $V_p$  is referent value

Condition : Pulse added time = 1000h

Resistance change =  $\pm 5\%$

Room temperature

Type	Power	K	$V_{p\max}$
FWFU	All power rate	0.70	500

# Fusible Wire Wound Fixed Resistor

Type FWFU Series

## THE DISCHARGE WAVEFORM OF A CAPACITOR

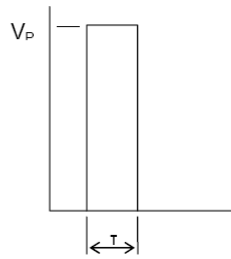
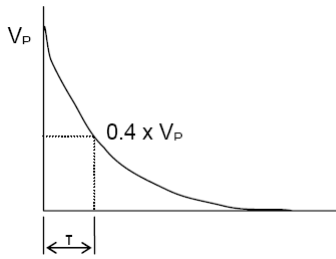

## SINE CURVE

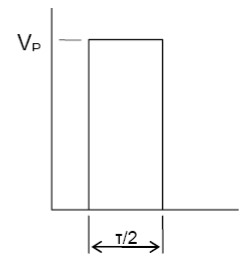
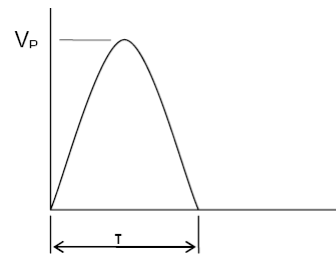

## TRIANGULAR WAVE

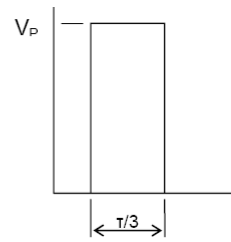
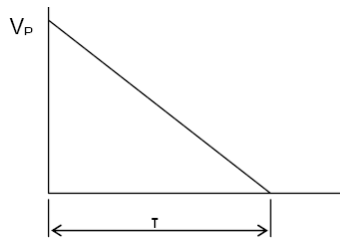

## SPECIAL WAVE

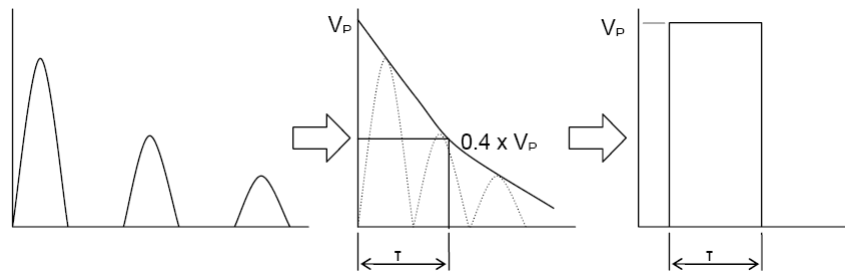

## 1.2/50μS LIGHTNING SURGE (IEC61000-4-5)

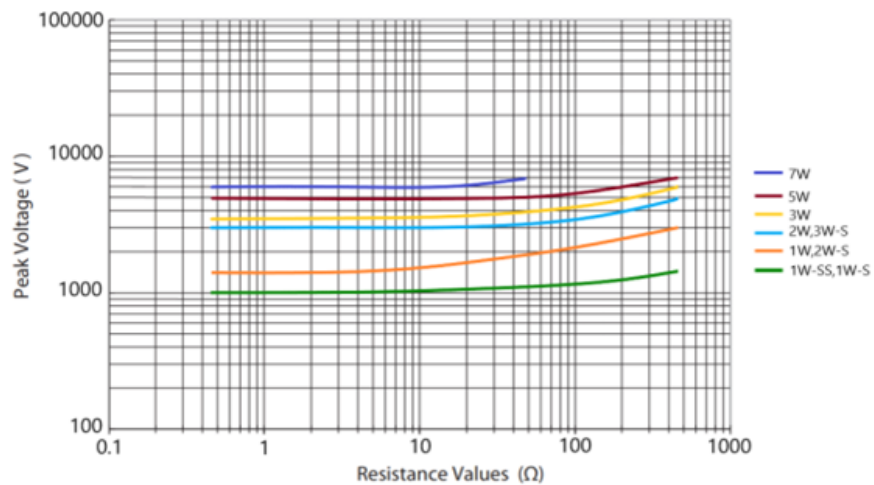

# Fusible Wire Wound Fixed Resistor

Type FWFU Series

## PAINTING METHOD

Welding point, terminal and lead wire, is permissible to be exposed without the outer coated cover. The extent should be within  $\frac{1}{2}$  of cap diameter

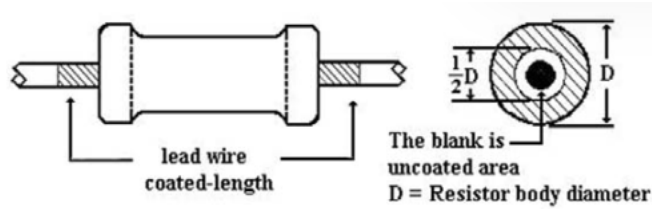

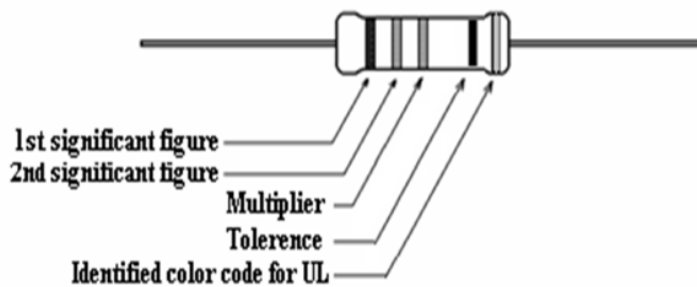

## MARKING

Resistors shall be marked with colour coding. Colours shall be in accordance with JIS C 0802



## LABELS

Label shall be marked with the following items:

TYCO Pn	5-2176794-7
DESC	FWFU 5W $\pm 5\%$ 100 R
QTY	1000 Pcs.
LOT	5220228
REF	TEST RoHS 3 (2015/863/EU)
 <span style="margin-left: 20px;">DC : 2522</span> 	

- (1) Type and style, resistance tolerance, nominal resistance
- (2) Quantity
- (3) Lot number

# Fusible Wire Wound Fixed Resistor

Type FWFU Series

## PACKAGING

### TAPING DIMENSIONS (mm)

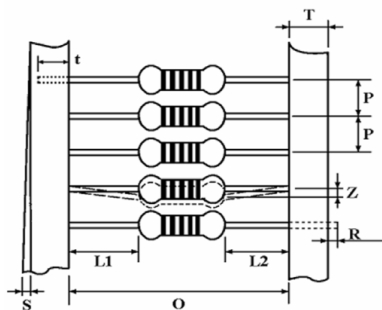

Type	Style	O	P	L1-L2	T	Z	R	t	S
FWFU 1W	PT-52	52 ± 1	5 ± 0.3	1 Max.	6 ± 1	1 Max.	0	4 ± 1	0.5 Max.
FWFU 2W	PT-64	64 ± 1	5 ± 0.3	1 Max.	6 ± 1	1 Max.	0	4 ± 1	0.5 Max.
FWFU 3W	PT-64	64 ± 1	10 ± 0.5	1 Max.	6 ± 1	1 Max.	0	6 ± 1	0.5 Max.
FWFU 1WSS	PT-52	52 ± 1	5 ± 0.3	1 Max.	6 ± 1	1 Max.	0	4 ± 1	0.5 Max.
FWFU 1WS	PT-52	52 ± 1	5 ± 0.3	1 Max.	6 ± 1	1 Max.	0	4 ± 1	0.5 Max.
FWFU 2WS	PT-52	52 ± 1	5 ± 0.3	1 Max.	6 ± 1	1 Max.	0	4 ± 1	0.5 Max.
FWFU 3WS	PT-64	64 ± 1	10 ± 0.5	1 Max.	6 ± 1	1 Max.	0	6 ± 1	0.5 Max.

### TAPE IN BOX PACKAGING (mm)

#### AMMO PACK

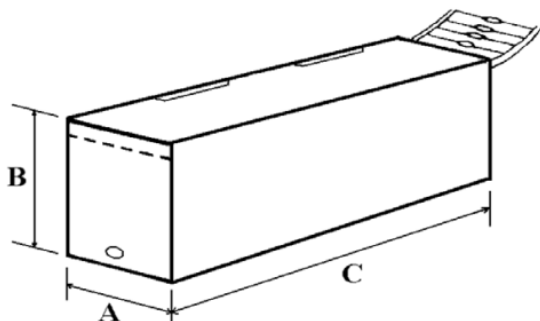

Type	Style	C ± 5	A ± 5	B ± 5	Quantity Per Box (pcs)
FWFU 1W	PT-52	262	86	80	1,000
FWFU 2W	PT-64	262	92	108	1,000
FWFU 3W	PT-64	256	92	80	500
FWFU 1WSS	PT-52	260	85	70	1,000
FWFU 1WS	PT-52	262	92	106	1,000
FWFU 2WS	PT-52	262	86	80	1,000
FWFU 3WS	PT-64	262	92	108	1,000

### TAPE ON REEL PACKAGING (mm)

(On request)

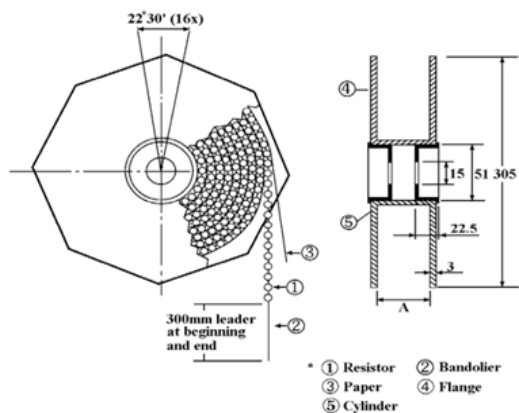

Type	Style	Across Flange (A)	Quantity Per Reel
FWFU 1W	PT-52	73 ± 2	2,500
FWFU 2W	PT-64	81 ± 5	1,000
FWFU 3W	PT-64	81 ± 5	500
FWFU 1WSS	PT-52	73 ± 2	2,500
FWFU 1WS	PT-52	73 ± 2	2,500
FWFU 2WS	PT-52	73 ± 2	2,500
FWFU 3WS	PT-64	81 ± 5	1000



# Fusible Wire Wound Fixed Resistor

Type FWFU Series

## BOX PACKING (PLASTIC CASE) (mm)

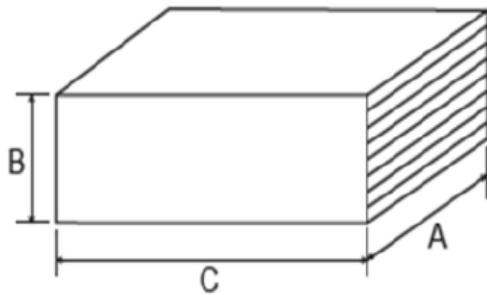

## BULK IN INNER BOX PACKING (PLASTIC CASE) (mm)

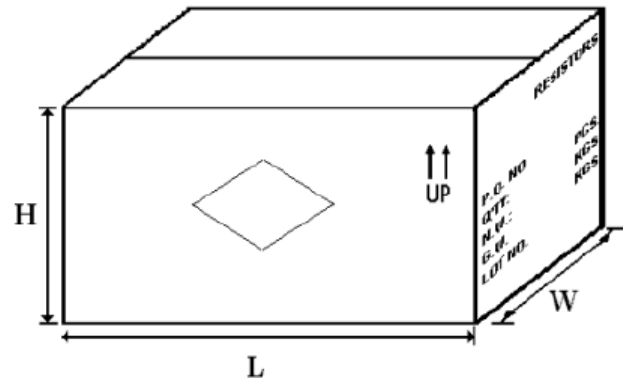

Type	C ± 5	A ± 5	B ± 5	Quantity Per Case/Box (pcs.)	L ± 5	W ± 5	H ± 5	Quantity Per Case/Box (pcs.)
FWFU 5W	36	20	8	100/1000	350	175	90	4,000
FWFU 7W	36	20	8	100/1000	350	175	90	4,000

## ENVIRONMENTAL RELATED SUBSTANCE

This product complies to EU RoHS directive, EU PAHs directive, EU PFOS directive and Halogen free.

Ozone layer depleting substances.

Ozone depleting substances are not used in our manufacturing process of this product. This product is not manufactured using Chloro fluorocarbons (CFCs), Hydrochlorfluorocarbons (HCFCs), Hydrobromofluorocarbons (HBFCs) or other ozone depleting substances in any phase of the manufacturing process.

## STORAGE CONDITION

The performance of these products, including the solderability, is guaranteed for a year from the date of arrival at your company, provided that they remain packed as they were when delivered and stored at a temperature of  $25^{\circ}\text{C} \pm 10^{\circ}\text{C}$  and a relative humidity of  $60\%\text{RH} \pm 10\%\text{RH}$ , chemical and dust free atmosphere.

Even within the above guarantee periods, do not store these products in the following conditions, otherwise their electrical performance and/or solderability may be deteriorated, and the packaging materials (e.g. taping materials) may be deformed or deteriorated, resulting in mounting failures.

1. In salty air or in air with a high concentration of corrosive gas, such as  $\text{Cl}_2$ ,  $\text{H}_2\text{S}$ ,  $\text{NH}_3$ ,  $\text{SO}_2$ , or  $\text{NO}_2$
2. In direct sunlight

## ORDERING INFORMATION

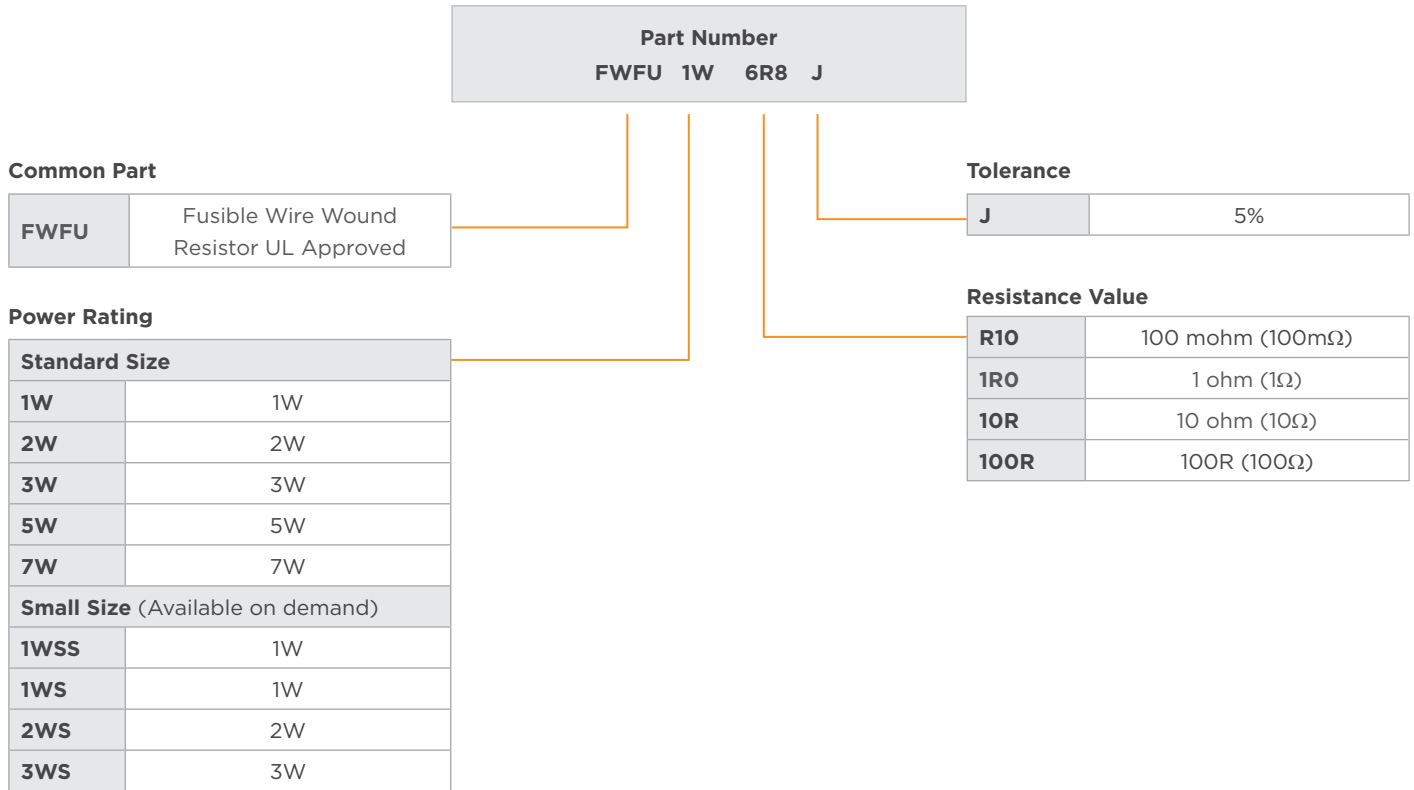

## te.com

©2025 TE Connectivity Plc. Family of Companies. All Rights Reserved.

TE Connectivity, TE connectivity (logo) and Every Connection Counts are trademarks owned or licensed by the TE Connectivity plc. family of companies. All other logos, products and/or company names referred to herein might be trademarks of their respective owners.

While TE has made every reasonable effort to ensure the accuracy of the information in this document, TE does not guarantee that it is error-free, nor does TE make any other representation, warranty or guarantee that the information is accurate, correct, reliable or current. TE reserves the right to make any changes to the information contained herein without prior notice. TE Connectivity assumes only those obligations set forth in the terms and conditions for this product and shall in no event be liable for any incidental, indirect, or consequential damages arising out of the sale, resale, use, or misapplication of the product. TE expressly disclaims any implied warranties with respect to the information contained herein, including, but not limited to, implied warranties of merchantability or fitness for a particular purpose. Dimensions, specifications and/or information contained herein are for reference purposes only and are subject to change without notice. Consult TE for the latest dimensions, specifications and/or information. Users of TE Connectivity products must make their own assessment as to whether the respective product is suitable for the respective desired application.

05/25 1773451 ED