

BUMPER

Features

- **Durable Construction** – Premium NR + SBR blend for superior strength and resilience.
- **Easy Installation:** Pre-drilled countersunk holes for quick, secure fixing
- **Impact Absorption:** Cushions shocks to protect vehicles, equipment, and property.

Rectangular Buffer 200L x 50W x 50H

SKU.: 0734093



RS Professionally Approved Products bring to you professional quality parts across all product categories. Our product range has been tested by engineers and provides a comparable quality to the leading brands without paying a premium price.

BUMPER

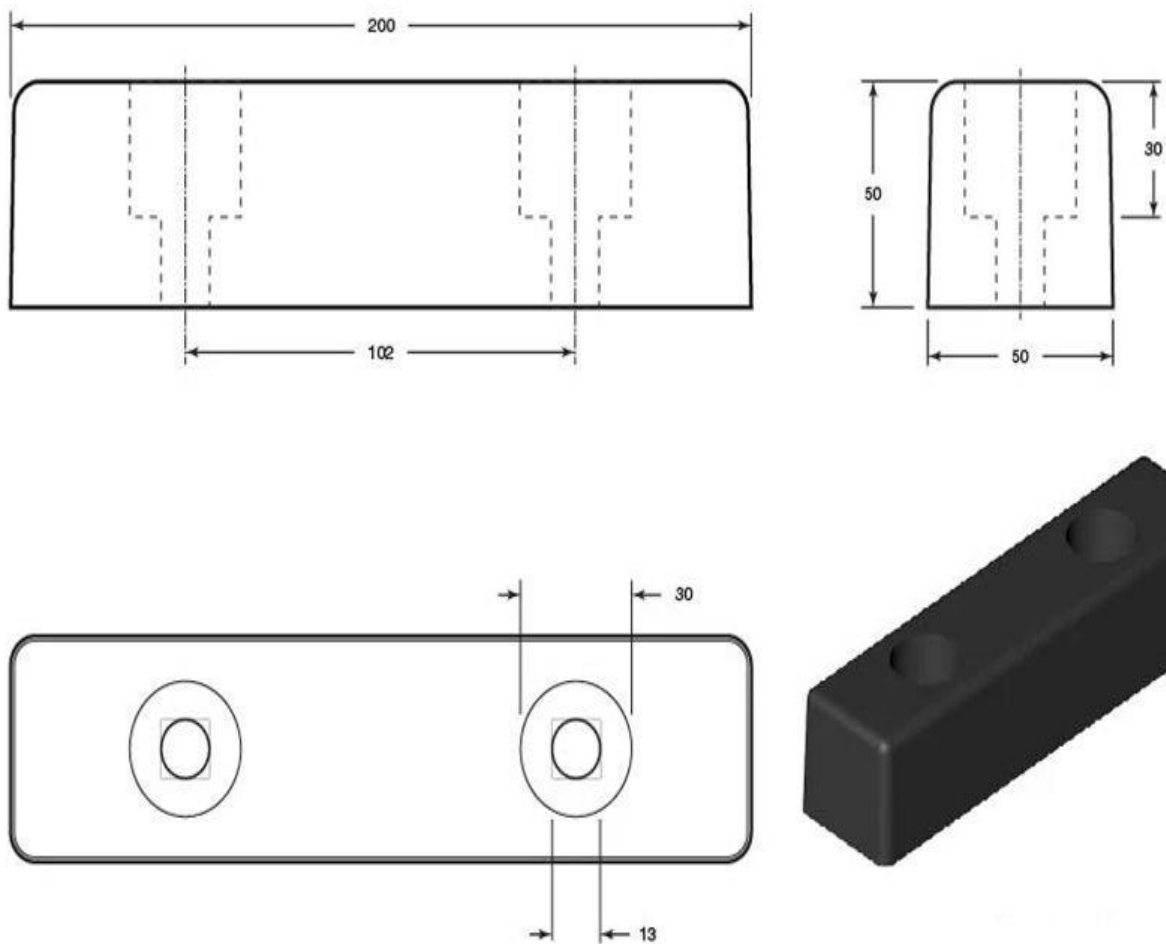

Bumper Dimensions

Length (mm)	200
Width (mm)	50
Height (mm)	50

BUMPER

Product Description

Rectangular Buffers are a versatile solution designed for a wide range of applications, including use on boats, lorries, trailers, and docking bays. Manufactured from a durable blend of NR and SBR rubber, these heavy-duty buffers deliver exceptional abrasion resistance, tear strength, and impact resilience, making them ideal for safeguarding vehicles, equipment, and property against damage. Their robust design ensures reliable performance in demanding environments, whether protecting fleets of vans and lorries during loading and unloading, cushioning forklift trucks in warehouses and loading bays, preventing impact damage to fragile glass rack carriers in transit, or serving as effective door and furniture buffers to reduce wear and scratches. Built to endure harsh outdoor conditions and easy to install with pre-drilled countersunk holes, Rectangular Buffers provide long-lasting protection and enhanced safety across industrial, commercial, and residential settings.

General Specifications

Material	NR/SBR
Colour	Black

Mechanical Specifications

Weight	0.09KG
Tensile Strength	4Mpa
Elongation	200%
Hardness	75ShA

Operation Environment Specifications

Maximum Temperature	70°C
Minimum Temperature	-15°C