

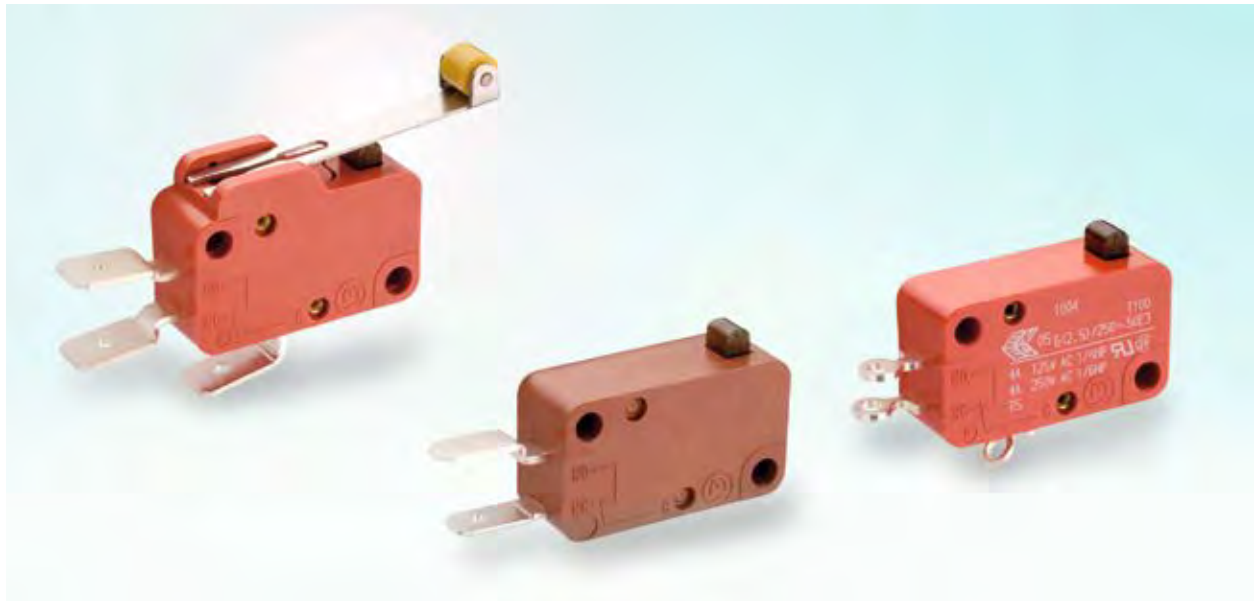

SERIES 1005 - MINIATURE SNAP-ACTION SWITCHES

TO 21 (8) A 250 V AC



PRODUCT FEATURES

- Friction contact system whose shearing movement can loosen welding
- Very high inrush currents (capacitive)
- Contact distances less and greater than 3 mm
- Operating forces from 0.2 to 4.2 N

ON REQUEST

- Material conformant with the filament wire test acc. to IEC 60335-1:2001 chap. 30
- Side bearing terminal
- Electrical rating 16 (16) A 250 V 5E4 for normally closed and normally open version

Design	DIN 41635 A
Mechanical life endurance	5E6 version with lever or contact spacing > 3 mm 10E6 standard version 5E4 version with curved spring steel lever
Contact resistance (new condition)	< 100 mOhm (1 A 12 V DC)
Insulation resistance (new condition)	> 100 MOhm (500 V DC)
Proof tracking	250 PTI
Ambient temperature	-40 °C ... +100 °C on request ... +125 °C ... +85 °C
Flammability	UL 94 (housing: V-0, actuator: V-2) UL 94 V-2
Glow wire test temperature	850 °C
Material additional actuator housing terminals	galvanized steel / spring steel / stainless steel Duroplast type 182 / PA glass fiber-reinforced / PA Latamid silver plated / chromated
Bounce time	< 10 ms
Approval marks	
Suitable for appliances of protection class II under compliance with the installation conditions required on the equipment side	

ROCKER SWITCHES

PUSHBUTTON SWITCHES

TOGGLE SWITCHES

SLIDE SWITCHES

ROTARY SWITCHES

FOOT SWITCHES

TACT AND KEY SWITCHES

SNAP-ACTION SWITCHES

MICRO-SIGNAL SWITCHES

SENSORS



























ECO

PUSH N' DRIVE



SERIES 1005 - MINIATURE SNAP-ACTION SWITCHES































TO 21 (8) A 250 V AC

	Normally closed contact (SPNC)			Normally open contact (SPNO)			Changeover switch (SPDT momentary)						
	1005.1105	1005.1101	1006.3402	1005.2809	1005.1207	1005.1226	1005.2505	1005.0904	1005.1204	1005.1201	1005.4001	1005.0404	1005.1004
21 (8) A 250 V AC 25E3				○									
20 (4) A 400 V AC 1E4					○							○	○
16 (16) A 250 V AC 5E4						○							
16 (4) A 400 V AC 5E4					○							○	○
16 (4) A 250 V AC 5E4													
16 (4) A 250 V AC 25E3													
12 (12) A 250 V AC 5E4							○						
10 (6) A 250 V AC 5E4	○				○			○	○			○	○
10 (4) A 400 V AC 1E4		○	○							○	○		
10 (4) A 250 V AC 5E4													
8 (8) A 250 V AC 5E4													
6 (2.5) A 400 V AC 5E4		○	○							○	○		
6 (2.5) A 250 V AC 5E4													
21 A 250 V AC 2 HP													
21 A 125 V AC 1 HP													
16 A 250 V AC 2 HP													
16 A 125 V AC 1 HP													
16 A 125 - 250 V AC 1/2 HP												○	○
10 A 125 - 250 V AC 1/2 HP	○								○				
10 A 125 - 250 V AC 1/4 HP		○	○							○	○		
8 A 125 - 250 V AC 1/3 HP													
4 A 125 - 250 V AC 1/6 HP													
Terminal type													
Terminal description	6.3	6.3	6.3	4.8 top side	6.3	6.3 straight	4.8 straight		6.3	6.3			6.3
Contact distance (mm)	Ag > 3	Ag < 3	Ag > 3	Ag > 3	Ag < 3	Ag < 3	Ag > 3	Ag > 3	Ag > 3	Ag < 3	Ag < 3	Ag < 3	Ag < 3
Contact material	Ag	Ag	Ag	Ag	Ag	Ag	Ag	Ag	Ag	Ag	Ag	Ag	Ag
Operating force (N)	2.6 - 4.2	1.5 - 2.5	1.6 - 2.8	2.4 - 3.8	2.4 - 3.8	2.4 - 3.8	3.5 - 4.9	2.4 - 3.8	2.4 - 3.8	1.5 - 2.5	1.5 - 2.5	2.4 - 3.8	2.4 - 3.8
Operating position (OP) (mm)	14.6±0.4	14.8±0.4	20.5±0.4	14.5±0.3	14.7±0.5	14.7±0.5	14.4±0.3	14.4±0.3	14.4±0.3	14.7±0.5	14.7±0.5	14.7±0.5	14.7±0.5
Difference travel max. (mm)	1.0	0.3	1.0	1.2	0.3	0.3	1.2	1.2	1.2	0.3	0.3	0.3	0.3
Free position (FP) max. (mm)	16	16	22.0	16	16	16	16	16	16	16	16	16	16
Permissible total travel position (TP) (mm)	13.4	13.4	19.3	13.4	13.4	13.4	13.4	13.4	13.4	13.4	13.4	13.4	13.4
Actuator description													
Lever drawing			L21										
Miscellaneous													
Stock version	○	○			○				○			○	○



SERIES 1005 - MINIATURE SNAP-ACTION SWITCHES

TO 21 (8) A 250 V AC















	Changeover switch (SPDT momentary)														
	1006.1514	1005.0507	1005.1010	1004.0509	1005.0101	1005.0401	1005.1001	1005.3501	1006.0701	1006.0901	1006.1011	1006.1101	1006.1201	1006.1301	1006.1401
21 (8) A 250 V AC 25E3	○														
20 (4) A 400 V AC 1E4															
16 (16) A 250 V AC 5E4	○														
16 (4) A 400 V AC 5E4		○	○												
16 (4) A 250 V AC 5E4				○											
12 (12) A 250 V AC 5E4															
10 (6) A 250 V AC 5E4	○	○													
10 (4) A 400 V AC 1E4					○	○	○	○	○	○	○	○	○	○	○
10 (4) A 250 V AC 5E4				○											
8 (8) A 250 V AC 5E4			○												
6 (2.5) A 400 V AC 5E4					○	○	○	○	○	○	○	○	○	○	○
6 (2.5) A 250 V AC 5E4															
21 A 250 V AC 2 HP															
21 A 125 V AC 1 HP															
16 A 250 V AC 2 HP															
16 A 125 V AC 1 HP															
16 A 125 - 250 V AC 1/2 HP	○	○		○											
10 A 125 - 250 V AC 1/2 HP			○												
10 A 125 - 250 V AC 1/4 HP					○	○	○	○	○	○	○	○	○	○	○
8 A 125 - 250 V AC 1/3 HP															
4 A 125 - 250 V AC 1/6 HP															
Terminal type															
Terminal description	6.3		6.3		M3		6.3					6.3	6.3	6.3	6.3
Contact distance (mm)	Ag < 3	Ag < 3	Ag > 3	Ag < 3	Ag < 3	Ag < 3	Ag < 3	Ag < 3	Ag < 3	Ag < 3	Ag < 3	Ag < 3	Ag < 3	Ag < 3	Ag < 3
Contact material	Ag	Ag	Ag	Ag	Ag	Ag	Ag	Ag	Ag	Ag	Ag	Ag	Ag	Ag	Ag
Operating force (N)	1.2 - 2.1	2.4 - 3.8	2.4 - 3.8	0.8 - 1.8	1.5 - 2.5	1.5 - 2.5	1.5 - 2.5	1.5 - 2.5	1.5 - 2.5	0.8 - 1.4	0.7 - 1.25	1.5 - 2.5	1.5 - 2.5	0.3 - 0.55	0.8 - 1.4
Operating position (OP) (mm)	20.8 ± 1.2	14.7 ± 0.5	14.4 ± 0.3	14.7 ± 0.5	14.7 ± 0.5	14.7 ± 0.5	14.7 ± 0.5	14.7 ± 0.5	20.8 ± 0.5	15.4 ± 1.2	20.8 ± 1.2	15.3 ± 0.5	20.8 ± 0.5	15.7 ± 2.7	15.4 ± 1.2
Difference travel max. (mm)	0.9	0.3	1.2	0.1 - 0.25	0.3	0.3	0.3	0.3	0.3	0.7	0.9	0.3	0.3	1.8	0.7
Free position (FP) max. (mm)	23.5	16	16	16	16	16	16	16	22.1	18.2	23.5	16.6	22.1	21.5	18.2
Permissible total travel position (TP) (mm)	18	13.4	13.4	13.4	13.4	13.4	13.4	13.4	19.5	12.6	18	14	19.5	9.8	12.6
Actuator description															
Lever drawing	L12								L11	L02	L12	L01	L11	L04	L02
Miscellaneous				milled bearing blade											
Stock version					○	○	○		○	○			○	○	○

ROCKER SWITCHES
PUSHBUTTON SWITCHES
TOGGLE SWITCHES
SLIDE SWITCHES
ROTARY SWITCHES
FOOT SWITCHES
TACT AND KEY SWITCHES
SNAP-ACTION SWITCHES
MICRO-SIGNAL SWITCHES
SENSORS
ECO
PUSH IN DRIVE



SERIES 1005 - MINIATURE SNAP-ACTION SWITCHES

TO 21 (8) A 250 V AC

	Changeover switch (SPDT momentary)						
	1006.1511	1006.1801	1006.4103	1006.4203	1004.4601	1004.0402	1004.1002
							
21 (8) A 250 V AC 25E3							
20 (4) A 400 V AC 1E4							
16 (16) A 250 V AC 5E4							
16 (4) A 400 V AC 5E4							
16 (4) A 250 V AC 5E4							
16 (4) A 250 V AC 25E3							
12 (12) A 250 V AC 5E4							
10 (6) A 250 V AC 5E4							
10 (4) A 400 V AC 1E4	○	○	○	○			
10 (4) A 250 V AC 5E4					○		
8 (8) A 250 V AC 5E4							
6 (2.5) A 400 V AC 5E4	○	○	○	○			
6 (2.5) A 250 V AC 5E4						○	○
21 A 250 V AC 2 HP							
21 A 125 V AC 1 HP							
16 A 250 V AC 2 HP							
16 A 125 V AC 1 HP							
16 A 125 - 250 V AC 1/2 HP							
10 A 125 - 250 V AC 1/2 HP							
10 A 125 - 250 V AC 1/4 HP	○	○	○	○			
8 A 125 - 250 V AC 1/3 HP					○		
4 A 125 - 250 V AC 1/6 HP						○	○
Terminal type							
Terminal description	6.3	6.3			6.3		6.3
Contact distance (mm)	< 3	< 3	< 3	< 3	< 3	< 3	< 3
Contact material	Ag	Ag	Ag	Ag	Ag	Ag	Ag
Operating force (N)	0.7 - 1.25	1.5 - 2.5	1.5 - 2.5	1.5 - 2.5	0.5 - 1.1	0.2 - 0.6	0.2 - 0.6
Operating position (OP) (mm)	20.8 ± 1.2	22 ± 1	20.8 ± 0.5	20.8 ± 0.5	20.8 ± 0.5	14.7 ± 0.5	14.7 ± 0.5
Difference travel max. (mm)	0.9	0.6	0.3	0.3	0.3	0.3	0.3
Free position (FP) max. (mm)	23.5	24.5	22.1	22.1	22.1	16	16
Permissible total travel position (TP) (mm)	18	18.5	19.5	19.5	19.5	13.4	13.4
Actuator description							
Lever drawing	L12	L31	L11	L11	L11		
Miscellaneous					milled bearing blade	milled bearing blade	milled bearing blade
Stock version	○					○	○





SERIES 1005 - MINIATURE SNAP-ACTION SWITCHES

TO 21 (8) A 250 V AC

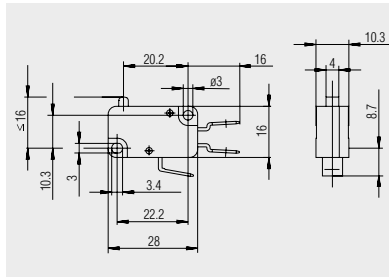

Basic type 1005



 Quick-connect terminal 6.3 x 0.8

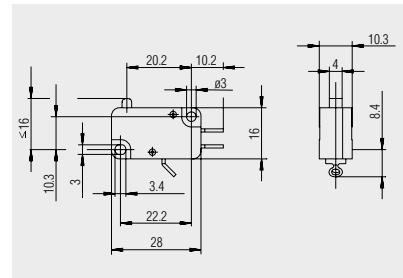

 Solder terminal

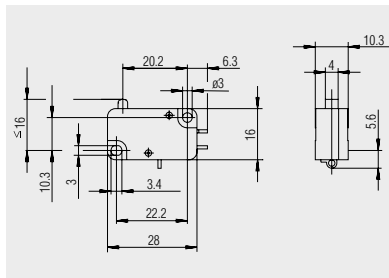

 Short solder terminal

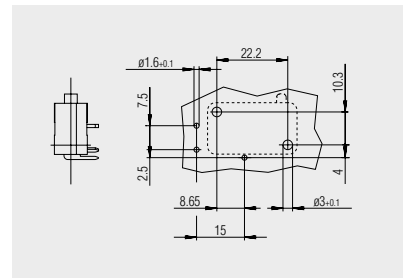

 PCB terminal (cover side)
right angled

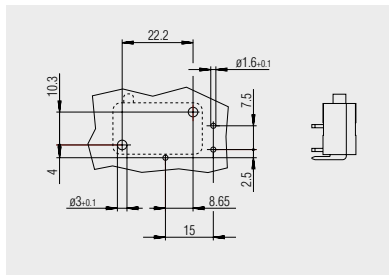

 PCB terminal (base side)
left angled

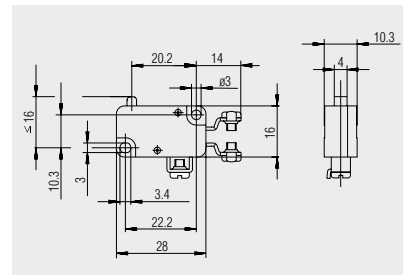

 Screw terminal M3

ROCKER SWITCHES

PUSHBUTTON SWITCHES

TOGGLE SWITCHES

SLIDE SWITCHES

ROTARY SWITCHES

FOOT SWITCHES

TACT AND KEY SWITCHES

SNAP-ACTION SWITCHES

MICRO-SIGNAL SWITCHES

SENSORS

ECO

PUSH N' DRIVE



SERIES 1005 - MINIATURE SNAP-ACTION SWITCHES

TO 21 (8) A 250 V AC



Basic type 1005

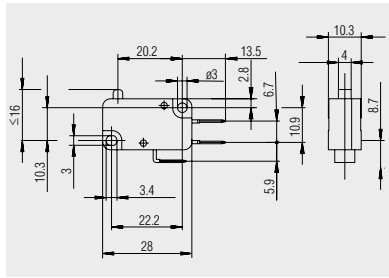

Quick-connect terminal 4.8 x 0.8 straight

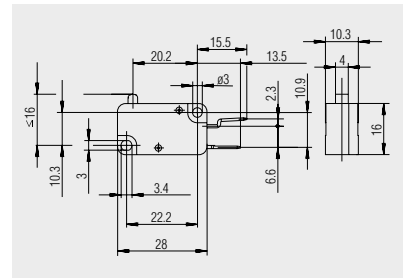

Quick-connect terminal 4.8 x 0.8 top side

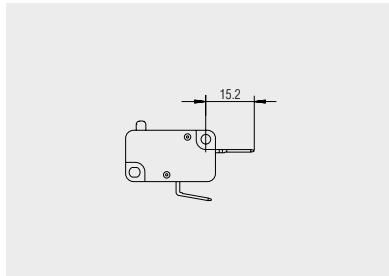

Quick-connect terminal 6.3 x 0.8 normally open contact version

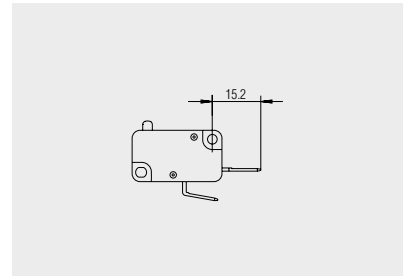

Quick-connect terminal 6.3 x 0.8 normally closed contact version



Basic types 1004 and 1005 switching positions

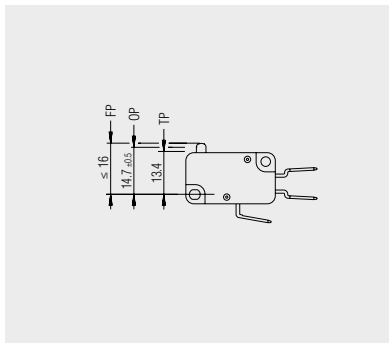

FP: free position

OP: operating position

TP: permissible total travel position

ROCKERSWITCHES

PUSHBUTTON SWITCHES

TOGGLE SWITCHES

SLIDE SWITCHES

ROTARY SWITCHES

FOOT SWITCHES

TACT AND KEY SWITCHES

SNAP-ACTION SWITCHES

MICRO-SIGNAL SWITCHES

SENSORS

ECO

PUSH'N'DRIVE



SERIES 1005 - MINIATURE SNAP-ACTION SWITCHES

TO 21 (8) A 250 V AC



Basic type 1006
auxiliary actuator

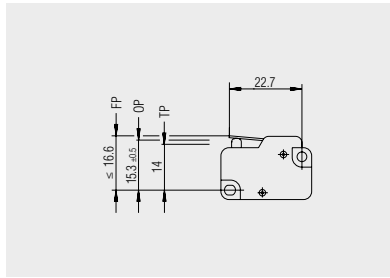

L01: straight lever

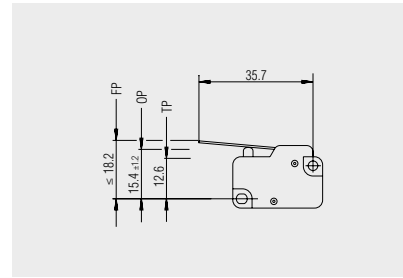

L02: straight lever

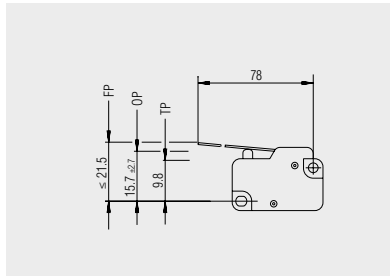

L04: straight lever

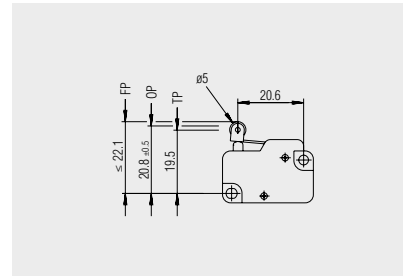

L11: roller lever

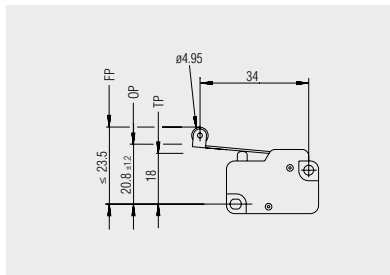

L12: roller lever

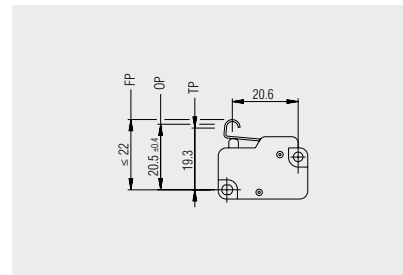

L21: simulated roller

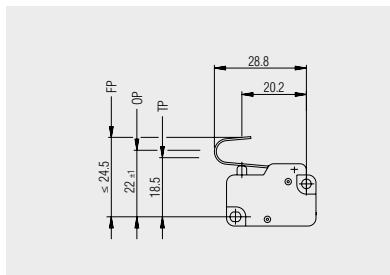

L31: spring lever

ROCKER SWITCHES

PUSHBUTTON SWITCHES

TOGGLE SWITCHES

SLIDE SWITCHES

ROTARY SWITCHES

FOOT SWITCHES

TACT AND KEY SWITCHES

SNAP-ACTION SWITCHES

MICRO-SIGNAL SWITCHES

SENSORS

ECO

PUSH 'N' DRIVE



SERIES 1005 - MINIATURE SNAP-ACTION SWITCHES

TO 21 (8) A 250 V AC

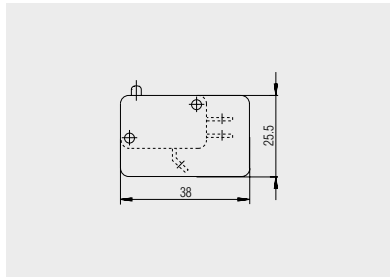

Insulating plate for solder terminal
0.5 mm: 231.009.011

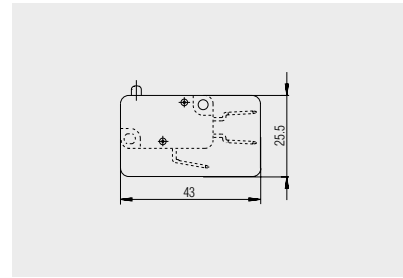

Insulating plate for quick-connect terminal
0.5 mm: 231.010.011
0.8 mm: 231.010.021

Additional parts

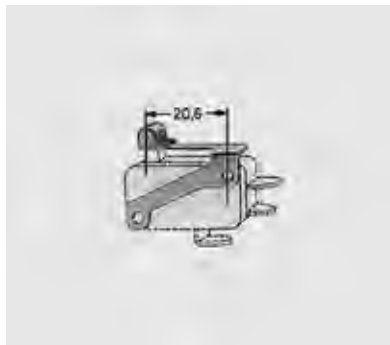

Stainless spring steel

Lever 20.6 long with roller diameter
5 out of PA yellow (to be mounted
lateral with the switch using screws)

191.013.013

Further information under

WWW.MARQUARDT-SWITCHES.COM

ROCKERSWITCHES

PUSHBUTTON SWITCHES

TOGGLE SWITCHES

SLIDE SWITCHES

ROTARY SWITCHES

FOOT SWITCHES

TACT AND KEY SWITCHES

SNAP-ACTION SWITCHES

MICRO-SIGNAL SWITCHES

SENSORS

ECO

PUSH'N'DRIVE

THIS DRAWING IS THE EXCLUSIVE PROPERTY OF MARQUARDT. WITHOUT THEIR CONSENT IT MAY NOT BE REPRODUCED OR GIVEN TO THIRD PARTIES.

CONFIDENTIAL

VERTRAULICH

Alle Rechte bei Marquardt, auch fuer den Fall von Schutzrechtsverletzungen. Jede Verueugungsbezugnis, wie Kopier- und Weitergaberecht, bei uns.

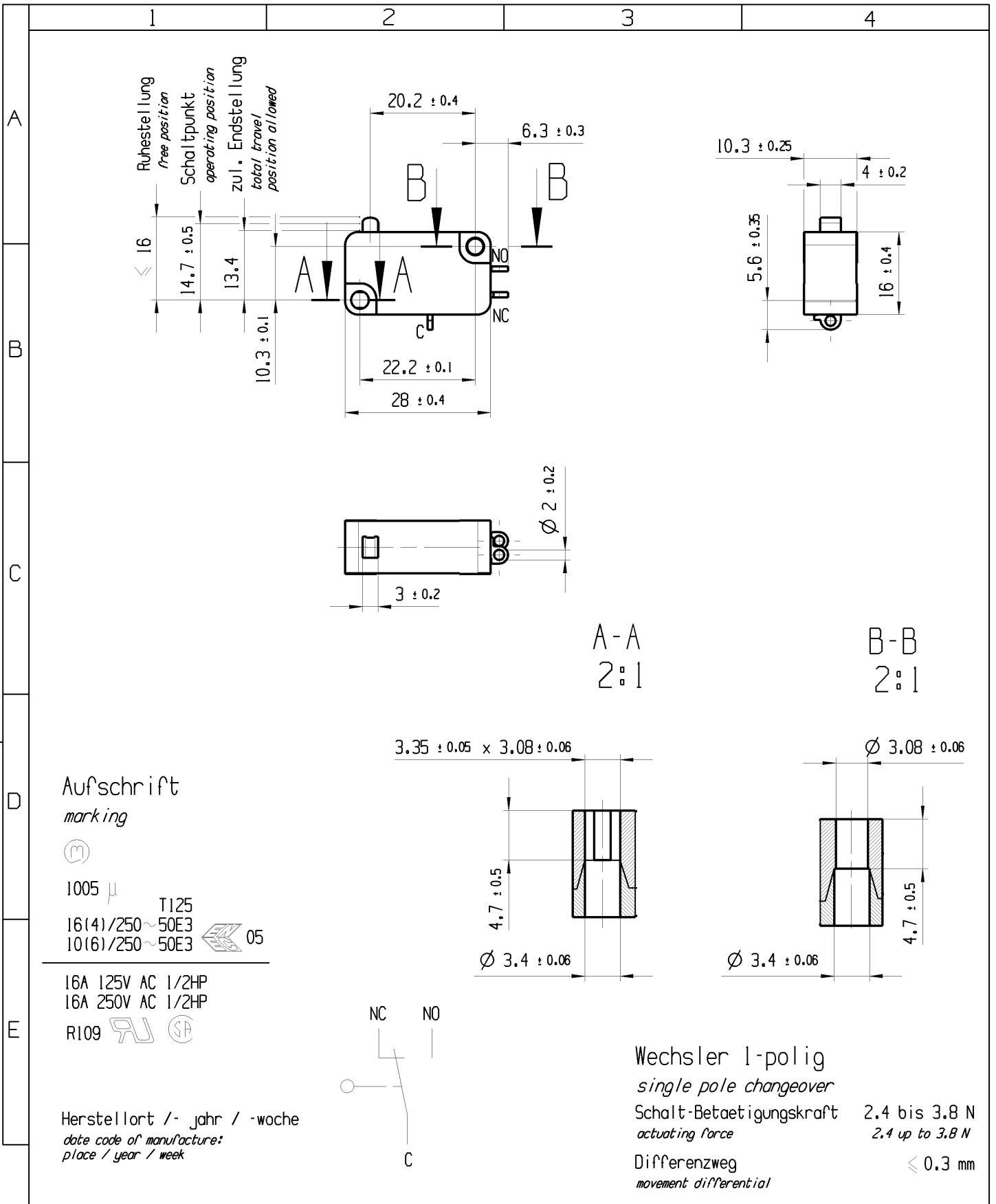

Aufschrift
marking



1005 μ

T125

16(14)/250~50E3

10(16)/250~50E3



16A 125V AC 1/2HP
16A 250V AC 1/2HP

R109

Herstellort /- jahr / -woche
date code of manufacture:
place / year / week

Wechsler 1-polig
single pole changeover

Schalt-Betaetigungskraft 2.4 bis 3.8 N
actuating force 2.4 up to 3.8 N

Differenzweg ≤ 0.3 mm
movement differential

fuer Form und Lage FOR SHAPE AND LOC.	⊙ =	Allgemeintoleranzen UNTOLERANCED DIMENSIONS				Pause COPY	Blatt SHEET 01	TYP K	Zeichn./DRAWING NO. 10050507	Index b
	fuer Winkel FOR ANGLE. ± 2	PROJEKTION	Abmasse und Nennmassbereiche Angaben in mm	Laenge LENGTH	Radial RADII					
			0-6 ± 0.1	± 0.2				SCHNAPPSCHALTER		
			>6-15 ± 0.15	± 0.3				snap action switch		
			>15-30 ± 0.2	± 0.5						
			>30-70 ± 0.3							
			>70-120 ± 0.4	± 10%						
			>120 ± 0.8							
b	85443	30.09.13	BRC			CAD: NX v6.0				
a	29121	02.02.00	PFU			gez./DRAWN BY 19.06.13 BCY				
		22.05.95				gepr./CHECKED BY				
Ausg. ISSUE	Aenderung REVISION	gez. DRAWN BY	Ausg. ISSUE	Aenderung REVISION	gez. DRAWN BY	Ersatz fuer/REPLACEMENT OF Zg.gl.Nr.v.22.05.1995		MARQUARDT		