

# ANT-DB1-WRT-ccc

## Data Sheet



### Product Description

The dual-band WRT Series antenna supports legacy 2.4GHz WiFi and newer 5.8GHz band applications in a single, compact antenna. The WRT's low profile and tamper resistant design is perfect for challenging applications such as wireless vending, security, traffic, and power equipment. The antenna is installed through a small hole in the enclosure and has an integrated closed-cell PSA ring to seal against the enclosure, protecting critical equipment from harsh, external elements. The WRT Series antenna features an integrated counterpoise that eliminates the need for additional ground plane in the product. It is optimized for applications with non-conductive or RF transparent enclosures.

The WRT Series antenna has a 216.0 mm (8.5") long coax cable with an RP-SMA, SMA or U.FL/MHF-compatible connector as standard options. It is easily customized with different cable lengths and connectors for volume orders. Contact Linx for details.

### Features

- Low cost
- Unobtrusive
- Tamper resistant
- Integral counterpoise
- Indoor / outdoor
- Adhesive or permanent mount

### Ordering Information

ANT-DB1-WRT-RPS (with RP-SMA connector)  
ANT-DB1-WRT-SMA (with SMA connector)  
ANT-DB1-WRT-UFL (with U.FL / MHF compatible connector)

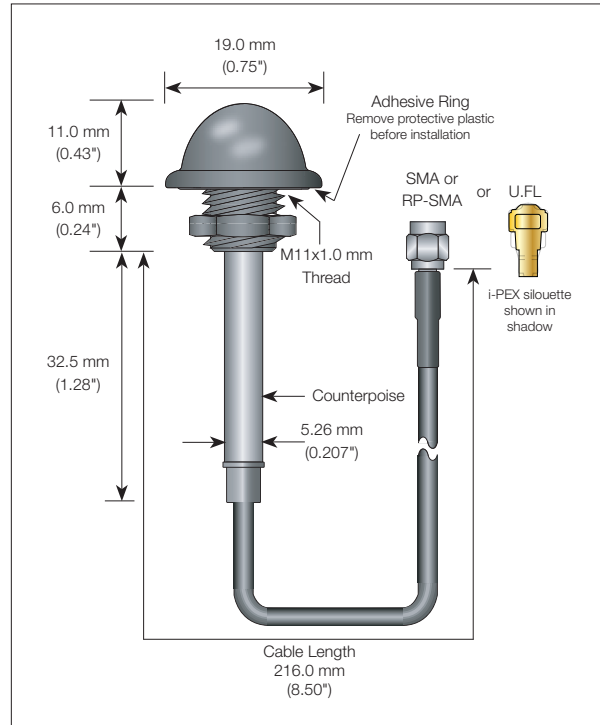

### Electrical Specifications

Center Frequency:	Band 1: 2.45GHz Band 2: 5.8GHz
Recom. Freq. Range:	Band 1: 2.40–2.50GHz Band 2: 5.725–5.875GHz
Bandwidth:	Band 1: 100MHz Band 2: 150MHz
Wavelength:	1/2-wave
VSWR:	< 2.0 typical at center
Peak Gain:	Band 1: 5dBi max Band 2: 4.3dBi max
Impedance:	50-ohms
Max. Power:	5W
Connector:	RP-SMA, SMA or U.FL / MHF
Cable:	RG-174, RP-SMA & SMA 1.32 mm U.FL
Oper. Temp. Range:	–40°C to +90°C
Max. Recom. Torque:	4.0 kgf-cm

Electrical specifications and plots measured on 10.16 cm x 10.16 cm (4.00" x 4.00") reference ground plane

## VSWR Graph

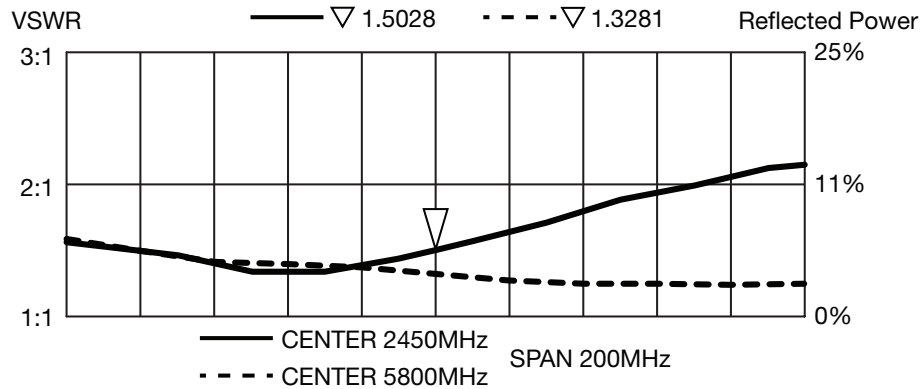

### What is VSWR?

The Voltage Standing Wave Ratio (VSWR) is a measurement of how well an antenna is matched to a source impedance, typically 50-ohms. It is calculated by measuring the voltage wave that is headed toward the load versus the voltage wave that is reflected back from the load. A perfect match has a VSWR of 1:1. The higher the first number, the worse the match, and the more inefficient the system. Since a perfect match cannot ever be obtained, some benchmark for performance needs to be set. In the case of antenna VSWR, this is usually 2:1. At this point, 88.9% of the energy sent to the antenna by the transmitter is radiated into free space and 11.1% is either reflected back into the source or lost as heat on the structure of the antenna. In the other direction, 88.9% of the energy recovered by the antenna is transferred into the receiver. As a side note, since the “:1” is always implied, many data sheets will remove it and just display the first number.

### How to Read a VSWR Graph

VSWR is usually displayed graphically versus frequency. The lowest point on the graph is the antenna's operational center frequency. In most cases, this is different than the designed center frequency due to fabrication tolerances. The VSWR at that point denotes how close to 50-ohms the antenna gets. Linx specifies the recommended bandwidth as the range where the typical antenna VSWR is less than 2:1.

# Gain Plots

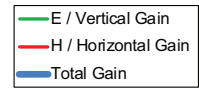

## 2450MHz

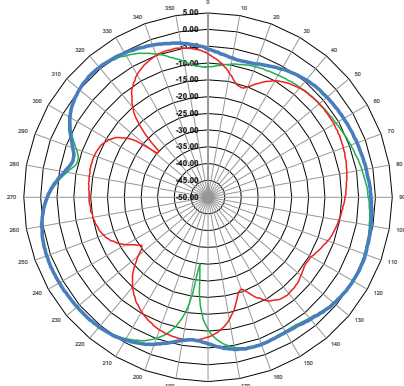

XZ-Plane Gain

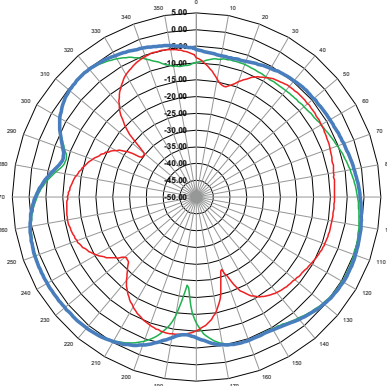

YZ-Plane Gain

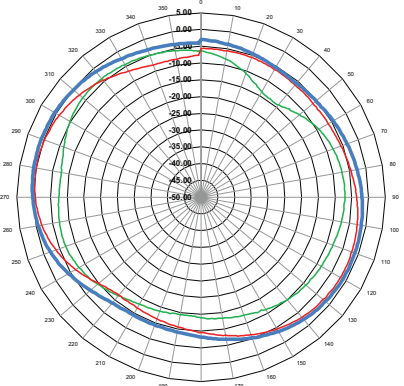

XY-Plane Gain

## 5800MHz

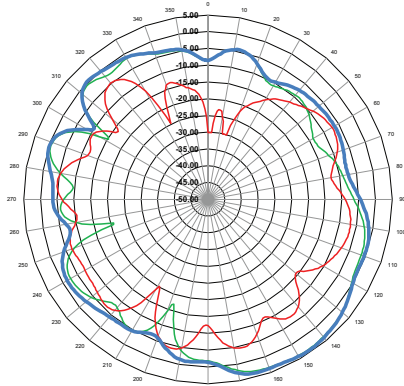

XZ-Plane Gain

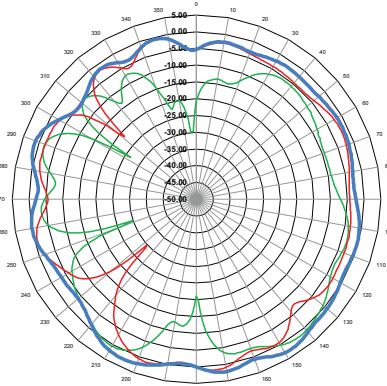

YZ-Plane Gain

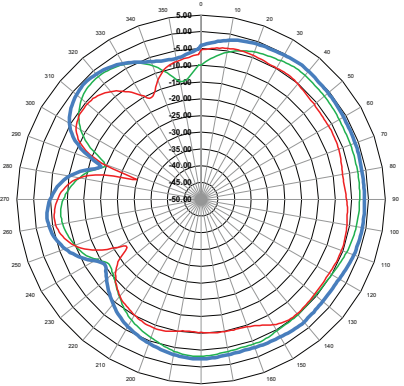

XY-Plane Gain

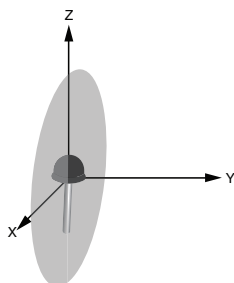

XZ-Plane Gain

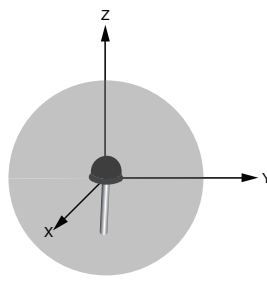

YZ-Plane Gain

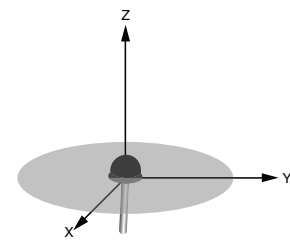

XY-Plane Gain

## About Gain Plots

The true measure of the effectiveness of an antenna in any given application is determined by the gain and radiation pattern measurement. For antennas gain is typically measured relative to a perfect (isotropic) radiator having the same source power as the antenna under test, the units of gain in this case will be decibels isotropic (dBi). The radiation pattern is a graphical representation of signal strength measured at fixed distance from the antenna.

Gain when applied to antennas is a measure of how the antenna radiates and focuses energy into free space. Much like a flashlight focuses light from a bulb in a specific direction, antennas focus RF energy into specific directions. Gain in this sense refers to an increase in energy in one direction over others.

It should also be understood that gain is not “free”, gain above 0dBi in one direction means that there must be less gain in another direction. Pictorially this can be pictured as shown in the figures to the right. The orange pattern represents the radiation pattern for a perfect dipole antenna, which is shaped like a donut. The pattern for an omnidirectional antenna with gain is shown in blue. The gain antenna is able to work with a device located further from the center along the axis of the pattern, but not with devices closer to the center when they are off the axis – the donut has been squished.

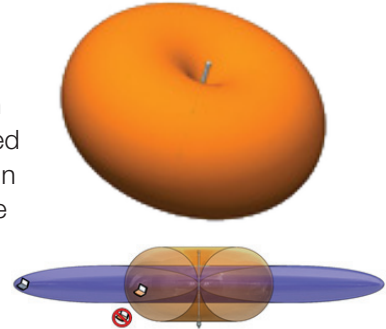

Gain is also related to the overall physical size of the antenna, as well as surrounding materials. As the geometry of the antenna is reduced below the effective wavelength (considered an electrically small antenna) the gain decreases. Also, the relative distance between an electrically small antenna and its associated ground impacts antenna gain.