RS Components

Your sensing guide

Panorama



Limit switches: OsiSense XC	Page 2
Pressure switches: OsiSense XM	Page 4
Inductives: OsiSense XS	Page 5
Photo-electrics: OsiSense XU	Page 6
Ultrasonic: OsiSense XX	Page 7
Forks: OsiSense XUV	Page 7

Simply easy!™

Limit switches: OsiSense XC



Choose : **1** > **2** > **3** > **4** > Reference
 Body Head Contact Connection

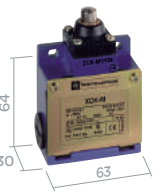
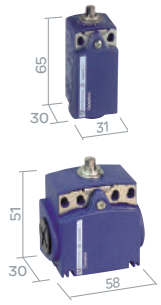

Model	Material	Contact	Connection	1	2	3	4	5	6	7	
XC KD	Metal	NO+NC Snap	M16	447-3480	447-3474	447-3496		447-3468	447-3519		
			M12 5P	814-7851	814-7848	814-7867		814-7845	814-7860	814-7879	
XC KP	Plastic	NO+NC Snap	M16	447-3418	447-3402	447-3430		609-6619	447-3395	447-3452	
			Pg11	700-4258	700-4254	700-4260		700-4169	700-4267	700-4166	
			M12 4P	814-7810	814-7804	814-7829		814-7801	814-7817	814-7835	
XC KT	Plastic	NO+NC Snap	M16	447-3525	447-3531	447-3553		283-555	447-3547	447-3569	
XC MD	Metal	NO+NC Snap	1 m	447-3834	447-3840	700-4157	700-4311	199-260	447-3878	283-577	
			NO+NC Slow	1 m		199-264			199-254	814-7794	
			NO+NC Snap	M12 5P		609-6625					814-7996
			1 C/O Snap	M12 4P	814-7797	609-6631	814-7790		814-8002		

Model	Material	Contact	Connection	1	2	3	4	5	6
XC KM	Metal	NO+NC Snap	M20	235-975	235-981	235-997		236-007	236-013
			Pg11	230-1923	700-4245	230-1951		230-1967	280-8799
XC KL	Metal	NO+NC Snap	CG	609-6546	609-6524	609-6568		609-6552	609-6530
XC KJ	Metal	NO+NC Snap	M20		235-931	700-4305	244-749	700-4309	700-4318
			Pg13	235-925		235-947	609-6518	235-953	235-969
			1/2NPT		814-7949	814-7933		814-7936	
			M12 5P						814-7930

(1) Plastic roller (2) Steel roller

Model	Material	Contact	Connection	1	2	3	Accessories
XC SA	Metal	NC+2NO Slow	M20	263-3595	263-3624	133-0083	252-3836
			Pg13	252-3757	397-2150	397-2166	252-3858
			1/2NPT	133-0084	700-4298	133-0086	
XC SPA	Plastic	NC+NO Slow	M16	296-4669	296-4675	132-9178	252-3870
			Pg11	252-3864	305-1966	132-9177	132-9180
			1/2NPT	700-4292	700-4302		

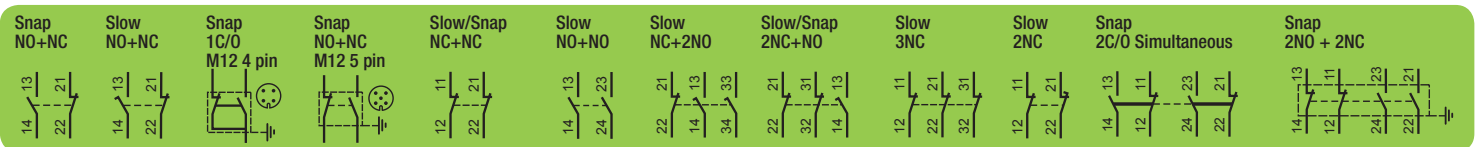

- M16 Tapped M16x1.5 for ISO cable gland
- M20 Tapped M20x1.5 for ISO cable gland
- Pg11 Tapped for a N°11 cable gland
- Pg13 Tapped for a N°13 cable gland
- 1/2NPT Tapped for a 1/2" NPT
- PF1/2 Tapped for a PF1/2"
- M12 5P Connector M12, 5 pin
- M12 4P Connector M12, 4 pin
- CG Tapped with cable gland include

Cabling XC

PUR pre-wired connectors (female)*			Connectors (female)	
M12			M12	
4 pin	2 m	695-6946	straight	521-201
	5 m	612-2235	elbowed	695-6886
	10 m	695-6943	elbowed PNP LED	695-6883
5 pin	5 m	695-6861	straight	695-6895
			elbowed	695-6889

(1) Steel ring (2) Plastic ring

*PVC version available on www.rs-online.com

Pressure switches: OsiSense XM

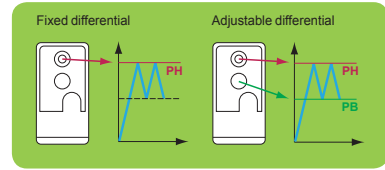
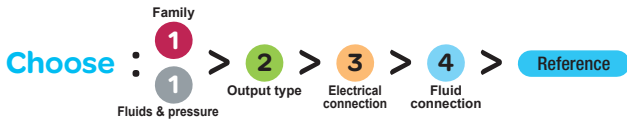

XMLA / XMLB Electromechanical

Hydraulic oils, air, fresh water, sea water / Temp: up to 70°C

1 C/O single pole contact fixed differential

1 C/O single pole contact adjustable differential

Screw terminal

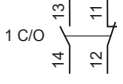

Bar	psi	ISO M20	Pg13	DIN connector	ISO M20	Pg13
-1	-14.5		609-6984		361-3508	324-1030
2.5	36.3		609-6912			324-0992
4	58	361-3435	302-5822		361-3378	324-1002
10	145	361-3441	302-5838	609-6928	361-3384	324-1018
20	290	361-3457	302-5844		361-3390	324-1024
35	508		609-6934			609-7016

Hydraulic oils / Temp: up to 160°C

G 1/4 (female)

Bar	psi	ISO M20	Pg13	DIN connector	ISO M20	Pg13
1	14.5		609-6906			609-6990
70	1015	361-3407	324-0958	124-2130		609-7022
160	2320	361-3413	324-0964			609-7038
300	4350	361-3429	324-0986			609-7044
500	7250	752-2692	609-6962		752-2529	609-7050

XMLR Electronic + Display

Hydraulic oils, air, fresh water, refrigerant fluids

-20... +80°C

Analogue output

Analogue + switching output

2 switching outputs

PNP - NO/NC programmable

PNP - NO/NC prog.

M12 4 pin or 5 pin



G 1/4A (female)

Bar	psi	Analogue output	Analogue + switching output	2 switching outputs
-1	-14.5			124-2161
1	14.5	124-2152		
10	145	835-2835	835-2848	835-2845
16	232	124-2154		
40	580			835-2857
100	1450		124-2156	124-2157
250	3625		835-2860	124-2158
400	5800	124-2159	124-2160	835-2867
				835-2879

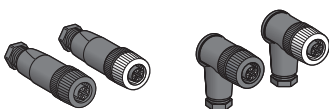

Cabling XM

Connectors (female)

PUR pre-wired connectors (female)*

	M12	straight	elbowed
(1)	4 pin	521-201	695-6886
(2)	4 pin	695-6895	695-6883
(1)	5 pin	695-6892	695-6889

	M12	straight	elbowed	elbowed PNP LED
(1)	4 pin	2 m	695-6946	695-6959
		5 m	612-2235	612-2257
		10 m	695-6943	695-6940

(1) Steel ring (2) Plastic ring

*PVC version available on www.rs-online.com

Inductives: OsiSense XS



Choose : **1** > **2** > **3** > **4** > Reference

Body size
Sensing distance Output type Connection Output function

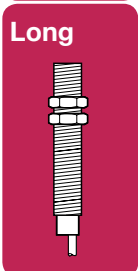

			M8		M12		M18		M30	
Sensing distance			1.5 mm	2.5 mm	2 mm	4 mm	5 mm	8 mm	10 mm	15 mm
DC3	PNP	cable	512-4448	695-6710	512-4482	695-6722	512-4511	695-6735	512-4561	695-6732
		connector	609-7347	695-6729	512-4498	695-6726	512-4533	695-6738	512-4577	695-6741
	NPN	cable	198-661		198-374		816-7621		816-7640	829-5102
		connector	816-3796		816-7615		816-7637		816-7334	
DC3	PNP	cable	700-1460	444-3243	700-1463	444-3265		444-3287	700-1479	444-3300
		connector	695-6744	444-3259	700-1467	444-3271	700-1476	444-3293	700-1473	444-3316
	NPN	cable		198-554		609-7353		695-6776		198-497
		connector	816-7596	695-6750		198-425	700-1476	198-532		816-7583
DC2	cable	512-4426		512-4454		512-4505		512-4555		
	connector	512-4432		512-4476		512-4549		512-4583		
AC/DC	cable				444-3322		444-3344		444-3366	
	connector				444-3338		444-3350		444-3388	

Accessories

M8	334-1720
M12	302-5850
M18	302-5872
M30	334-1758

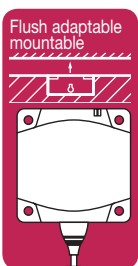
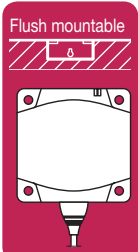

			∅ 8x22x8 mm	∅ 15x32x8 mm	∅ 26x26x13 mm	∅ 40x40x15 mm	∅ 80x80x26 mm
Sensing distance			2.5 mm	5 mm	10 mm	15 mm	40 mm
DC3	PNP	cable		753-7023	753-6994		753-6969
		connector	753-7051			753-6840	
	NPN	cable		753-7013		753-6922	
		connector					
DC2	cable	816-3654	753-7007			816-7338	
	connector						

			∅ 26x26x13 mm	∅ 40x40x15 mm	∅ 80x80x26 mm
Sensing distance			15 mm	25 mm	60 mm
DC3	PNP	cable	444-3136	444-3164	444-3186
		connector	444-3142	444-3170	444-3192
	NPN	cable	753-6907	753-6868	
		connector			
AC/DC	cable		695-6791	695-6794	
	connector		695-6782	829-5108	

			Cubic	∅ 40x40x117 mm	20 mm	40 mm
DC4	PNP	NO+NC		772-9828	772-9843	
	NPN	NO+NC		772-9837	772-9846	
DC2		NO		772-9830	772-9840	
AC/DC		NO		772-9834	772-9859	

DC3 24 V

DC4 24 V

Accessories

For 40x40 447-4001 447-4017

AC/DC 24...240 V

DC2 24 V

	Connector M8 3 pin
	Connector M12 4 pin
	Connector 1/2" 3 pin

Cabling XS

PUR pre-wired connectors (female)*

M8	straight	elbowed	
3 pin	2 m	695-6912	695-6924
	5 m	695-6851	695-6855
	10 m	695-6918	695-6921
1/2"			
	3 pin	5 m	695-6873

PUR pre-wired connectors (female)*

M12	straight	elbowed	elbowed PNP LED	
4 pin	2 m	695-6946	695-6959	695-6956
	5 m	612-2235	612-2257	695-6965
	10 m	695-6943	695-6940	695-6952

Connectors (female)

M12	straight	elbowed	
4 pin	(1)	521-201	695-6886
	(2)	695-6895	695-6883

(1) Steel ring (2) Plastic ring

*PVC version available on www.rs-online.com

Photo-electrics: OsiSense XU

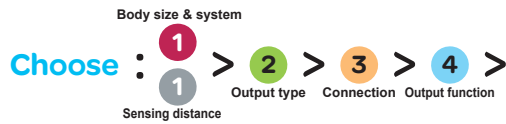

Sensing distance		M18 metal		M18 plastic		Miniature		Compact 50x50 mm		Compact 92x71 mm								
	0.6 m	DC3	PNP	cable	283-533	609-0778	1 m	686-2227	1 m	DC3	PNP	cable	753-0261	2.1 m	DC3	PNP	terminals	753-0397
				connector 4P	695-6823	609-0784		connector 4P				695-6839	connector 4P				753-0387	
	0.1 m	DC3	PNP	cable	752-5039	752-5023		816-7558	NPN	cable	753-0258	NPN	terminals	753-0390				
				connector 4P	752-5051	752-5045		816-7552		connector 4P			connector 4P					
				connector 4P	695-6817	695-6811		AC/DC		Relay	cable		512-4662	AC/DC	Relay	terminals	695-6845	
				connector 4P	695-6820	695-6811												

Sensing distance		M18 metal		M18 plastic		Miniature		Compact 50x50 mm		Compact 92x71 mm								
	2 m	DC3	PNP	cable	752-5133	752-5124	5 m	686-2205	5 m	DC3	PNP	cable	753-0299	11 m	DC3	PNP	terminals	753-0422
				connector 4P	695-6827	752-5143		connector 4P				695-6833	connector 4P				753-0413	
	2 m	DC3	NPN	cable	752-5155	752-5146		816-7561	NPN	cable	753-0286	NPN	terminals					
				connector 4P	752-5155	752-5146		816-7564		connector 4P			connector 4P					
				connector 4P	281-1751	281-1751		281-1751		AC/DC	Relay		cable	512-4656	AC/DC	Relay	terminals	695-6849
				Accessory: Reflector	281-1751	281-1751		281-1751										

Sensing distance		M18 metal		M18 plastic		Miniature		Compact 50x50 mm		Compact 92x71 mm								
	4 m	DC3	PNP	cable	752-5231	198-469	7 m	686-2205	7 m	DC3	PNP	cable	744-1060	14 m	DC3	PNP	terminals	753-0476
				connector 4P	695-6805	695-6801		connector 4P				695-6836	connector 4P				753-0466	
	4 m	DC3	NPN	cable	752-5228	752-5212		816-7561	NPN	cable	753-0331	NPN	terminals	753-0479				
				connector 4P	752-5240	752-5234		816-7564		connector 4P			connector 4P					
				connector 4P	281-1751	281-1751		281-1751		AC/DC	Relay		cable	512-4640	AC/DC	Relay	terminals	609-0813
				Accessory: Reflector	281-1751	281-1751		281-1751										

Sensing distance		M18 metal		M18 plastic		Miniature		Compact 50x50 mm		Compact 92x71 mm								
	15 m	DC3	PNP	cable	752-5180	198-992	15 m	686-2220	30 m	DC3	PNP	cable	753-0315	40 m	DC3	PNP	terminals	
				connector 4P	752-5219	752-5193		connector 4P				753-0325	connector 4P					
	15 m	DC3	NPN	cable	752-5161	752-5196		816-7546	NPN	cable	753-0303	NPN	terminals					
				connector 4P	752-5196	752-5196		816-7555		connector 4P			connector 4P					
				connector 4P	695-6814	752-5060		686-2217		cable	744-1063		terminals	444-3603				
				Accessory: Transmitter	752-5067	198-952		686-2217		connector 4P	753-0274		connector 4P	444-3580				

Sensing distance		M18 metal		M18 plastic		Miniature		Compact 50x50 mm		Compact 92x71 mm								
	Background suppression (BGS)	DC3	PNP	cable	444-3445	444-3394	15 m	686-2220	30 m	DC3	PNP	cable	444-3524	40 m	DC3	PNP	terminals	444-3574
				connector 4P	444-3451	444-3401		connector 4P				444-3530	connector 4P				444-3568	
	Diffuse (D)	DC3	NPN	cable	752-5102	695-6798		662-6241	NPN	cable	455-4983	NPN	terminals	444-3619				
				connector 4P	752-5109	695-6808		753-0353		connector 4P			connector 4P					
				connector 4P	444-3467	444-3417		444-3502		DC	cable		444-3546	DC	terminals	444-3603		
				Accessory: Transmitter	444-3473	444-3423		444-3518		AC/DC	cable		444-3552	AC/DC	connector 4P	444-3580		

Reflectors

281-1739 281-1767 281-1751 324-1585

3D fixings with ball joint

Bracket with ball joint for sensors and reflector 281-1751

XUB 444-3631
XUM0 444-3647
XUK... 444-3669
XUX... 444-3675

Other fixings

Single bracket

standard with ball joint

XUB 609-0829 (stainless steel) 370-4317 (plastic)
XUK 512-4606
XUX 609-0835

DC3 24 V

AC/DC Relay 24...240 V

Cabling XU

M8		M12		M12			M12				
PUR pre-wired connectors (female)*		PUR pre-wired connectors (female)*		PUR pre-wired connectors (female)*			Connectors (female)				
straight		elbowed		straight	elbowed	elbowed PNP LED	straight	elbowed			
4 pin	2 m	695-6937	695-6934	4 pin	2 m	695-6946	695-6959	695-6956	4 pin (1)	521-201	695-6886
	5 m	695-6864	695-6867		5 m	612-2235	612-2257	695-6965	4 pin (2)	695-6895	695-6883
	10 m	695-6928	695-6930		10 m	695-6943	695-6940	695-6952			

(1) Steel ring (2) Plastic ring

*PVC version available on www.rs-online.com

Ultrasonic: OsiSense XX



Body size

Choose : **1** > **2** > **3** > **4** > Reference

Sensing distance

Output function

Output type

Connection

	M12		M18		M18 metal	M30		M30 stainless
Sensing distance	0.05 m	0.1 m	0.15 m	0.5 m Adjust.	0.05 m fixed	1 m Adjust.	8 m Adjust.	1 m Adjust.
Connectors/Cables	M8 4 pin	M8 3 pin	M12 4 pin	M12 4 pin	M12 4 pin	M12 4 pin	M12 4 pin	M12 4 pin
NO	DC4 PNP/NPN 753-0508	612-2241	283-599	612-2229 (1)	764-0605	695-6858	753-0551 (1)	
NO+NC	DC4 PNP					612-2106	612-2128	742-0827
Analogue	4...20 mA 0...10 V		753-0511 (1) 753-0517 (1)			753-0545 (1) 753-0542 (1)	612-2112 612-2162	742-0824

(1) Adjustable with 612-2184

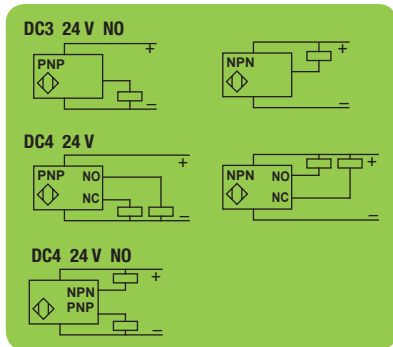

	Flat 7.6x19x33	Flat 60x30x18 + M18
Sensing distance	0.1 m	0.5 m Adjust.
Connectors	M12 4 pin	M12 4 pin
NO	DC3 PNP 612-2156	612-2190 (1)

(1) Adjustable with 612-2184

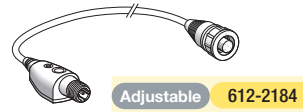
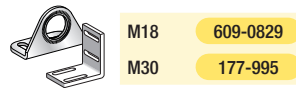
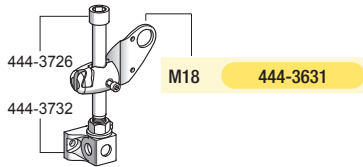

Forks: OsiSense XUV

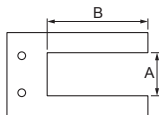

	A: 50 mm / B: 60 mm		A: 80 mm / B: 60 mm		A: 120 mm / B: 120 mm		A: 180 mm / B: 120 mm	
DC3	PNP	M8 3 pin	695-6968	695-6978	695-6993	695-7006		
	NPN	M8 3 pin		695-6987		695-7000		

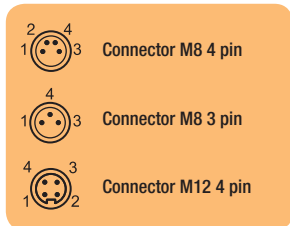
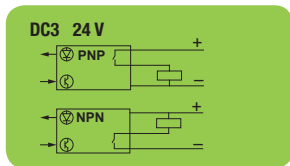

Cabling XX & XUV

M8	PUR pre-wired connectors (female)*			Connectors (female)		
	straight	elbowed	elbowed PNP LED	M12 straight	M12 elbowed	
3 pin	2 m	695-6912	695-6924	(1) 4 pin	521-201	695-6886
	5 m	695-6851	695-6855	(2) 4 pin	695-6895	695-6883
	10 m	695-6918	695-6921	(1) Steel ring (2) Plastic ring		
4 pin	2 m	695-6937	695-6934			
	5 m	695-6864	695-6867			
	10 m	695-6928	695-6930			
M12				Connectors (male)		
				M12 straight	M12 elbowed	
	4 pin	2 m	695-6946	695-6959	695-6956	
	5 m	612-2235	612-2257	695-6965		
	10 m	695-6943	695-6940	695-6952		
				4 pin	695-6902	695-6899
				5 pin	695-6906	695-6909

*PVC version available on www.rs-online.com

RS Components

Birchington Road
Corby
Nothants
NN17 5JF

www.rs-online.com

Telemecanique Sensors

United Kingdom
Strafford Park 5,
Telford
Shropshire
TF3 3BL

www.tesensors.com

Due to evolution of standards and equipment, characteristics indicated in texts and images in this document are binding only after confirmation by our departments.

Design : IGS-CP
Photos : Schneider Electric
Print :