

KEMET Part Number: OHD5R-115B
(USEO5R115B0000)

KEMET, OHD, Thermal Reed Switch, Radial, 5C Temperature Accuracy, High Reliability, High-Speed Response, Long Operational Life, Excellent Environmental Durability, High Temperature Accuracy, 115°C, Break

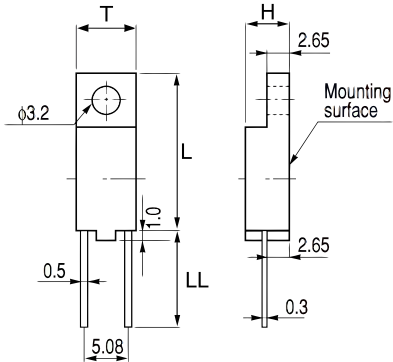

General Information	
Series:	OHD
Type:	Thermal Reed Switch
Style:	Radial
Description:	Thermal Guard
Features:	High Reliability, High-Speed Response, Long Operational Life, Excellent Environmental Durability, High Temperature Accuracy
Lead:	Wire Leads
RoHS:	Yes

Dimensions	
L	18.1mm
H	5mm
T	6.7mm
LL	10mm

Packaging Specifications	
Packaging:	Tray, Box
Packaging Quantity:	700
Weight:	1.1 g

Specifications	
Switching Temperature:	115C +/-5C
Temperature Range:	-20/+150C
Contact Type:	Break
Voltage DC:	30 VDC MAX (Opening/Closing), 1500 VAC /1 minute or 1800 VAC /1 second
Current:	0.1 Amps DC MAX (Opening/ Closing), 0.1 mAmps MIN (1VDC, Opening/Closing)
Resistance:	300 mOhms MAX (Contact Resistance)
Max Opening/Closing Power:	1 W (DC)
Max Opening/Closing Voltage:	30 V (DC)
Differential Temperature:	10C Maximum