

TOLERANCES (UNLESS SPECIFIED)	
0-10mm	±0.2mm
10.1-50mm	±0.5mm
50.1-250mm	±1.0mm
>250mm	±2.0mm

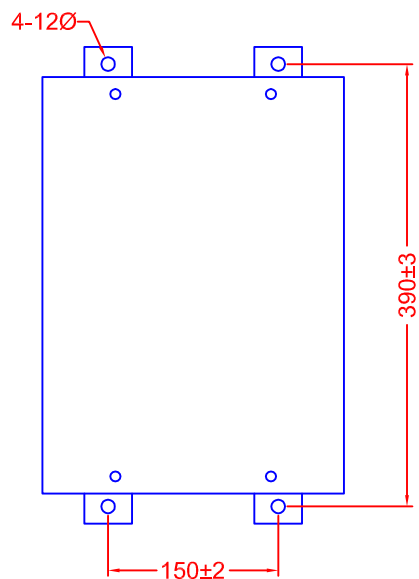
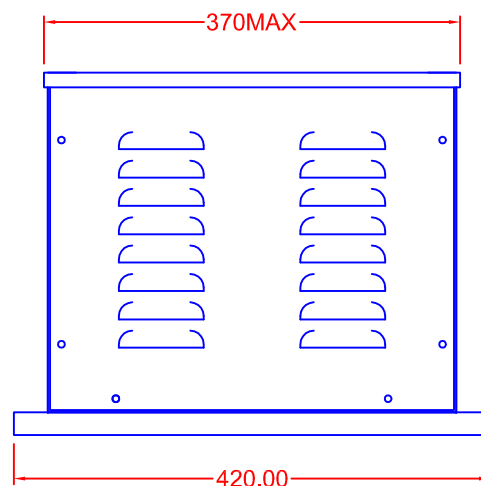
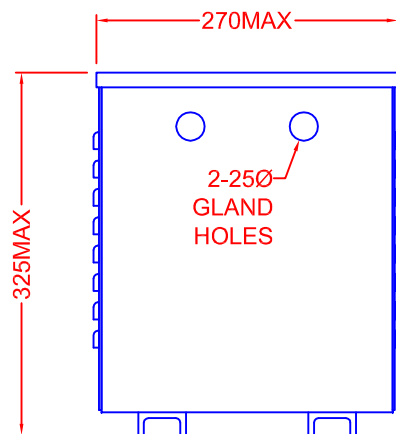

FLOOR MOUNTING TRANSFORMER
 TYPE: 3 PHASE AUTOTRANSFORMER
 STEP UP OR STEP DOWN
 VOLTAGES 380V / 400V / 415V
 RATING: 10KVA
 ENCLOSURE: MILD STEEL
 RATED IP22
 COLOUR: RAL 7032

REV	
4	
3	
2	
1	

CARROLL & MEYNELL
 TRANSFORMERS LIMITED
 TEL: 01642 617406 FAX: 01642 614178
 enquiries@carroll-meynell.com

TITLE 3 PHASE
 AUTOTRANSFORMER
 CMA10K/FM0
 ALL DIMENSIONS IN mm

DRAWN	PROJECTION	DATE	SCALE
SH		26/4/8	NTS
DRAW No	REV	PAGE	
3290	0	1/1	