

DETAILS

Product Number	C13299_STRADA-2X2-ME
Family	Strada-Module
Type	Lens array
Color	clear
Diameter	50 + 50 mm
Height	7,1 mm
Style	square
Optic Material	PMMA
Holder Material	
Fastening	screw, pin, glue
Status	ready
ROHS Compliant	Yes
Date Updated	6/10/2015



OPTICAL PROPERTIES

LED	Viewing Angle	Light Beam	Efficiency	cd/lm	Connector
XT-E	Asymmetric deg	Streetligh...	94 %	1.000	-
XM-L	Asymmetric deg	Streetligh...	94 %	0.700	-
NS9x383	Asymmetric deg	Streetligh...	94 %	0.600	-
XB-D	Asymmetric deg	Streetligh...	94 %	1.150	-
XP-G2	Asymmetric deg	Streetligh...	94 %	1.100	-
XP-G	Asymmetric deg	Streetligh...	94 %	1.000	-
Oslon Square PC	Asymmetric deg	Streetligh...	94 %	1.000	-
LUXEON R	Asymmetric deg	Streetligh...	94 %	0.900	-
LUXEON Rebel ES	Asymmetric deg	Streetligh...	94 %	1.000	-
LUXEON T	asymmetric deg	Streetligh...	94 %	0.970	-
Z5P	Asymmetric deg	Streetligh...	94 %	1.000	-
Acrich MJT 4040	Asymmetric deg	Streetligh...	94 %	0.800	-
H35C1 (LEMWA33)	Asymmetric deg	Streetligh...	94 %	0.900	-
LUXEON Z ES	Asymmetric deg	Streetligh...	94 %	1.400	-
XQ-E	sim: Asymmetric	Streetligh...	sim: 90 %	sim: 0.000	-
XP-E2	Asymmetric deg	Streetligh...	94 %	1.300	-
Z5M	Asymmetric deg	Streetligh...	94 %	1.000	-
LUXEON Q	asymmetric deg	Streetligh...	94 %	1.000	-
LUXEON H50-2	sim: Asymmetric	Streetligh...	-	sim: 0.000	-
Z5M1/Z5M2	asymmetric deg	Streetligh...	94 %	0.800	-
XM-L2	asymmetric deg	Streetligh...	94 %	0.700	-
XP-L	Asymmetric deg	Streetligh...	94 %	0.720	-
XB-H	sim: Asymmetric	Streetligh...	sim: 91 %	sim: 0.000	-
LUXEON MZ	asymmetric deg	Streetligh...	94 %	0.700	-
NVSxx19B/NVSxx19C	asymmetric deg	Streetligh...	94 %	0.900	-

D C B A

4

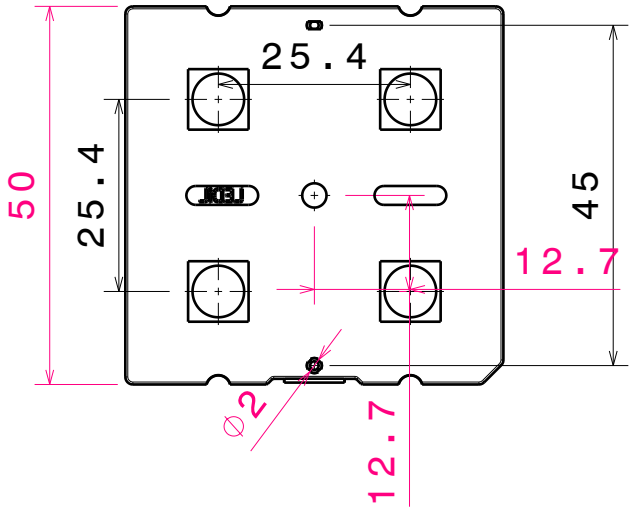

Bottom view

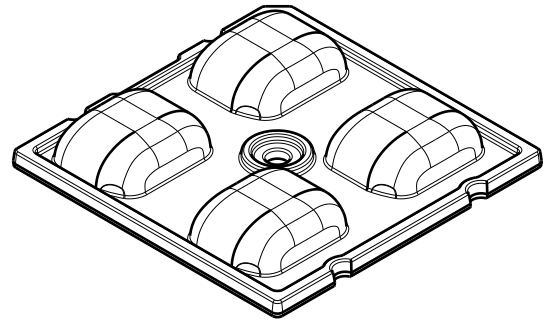

Isometric view

3

Beam Direction

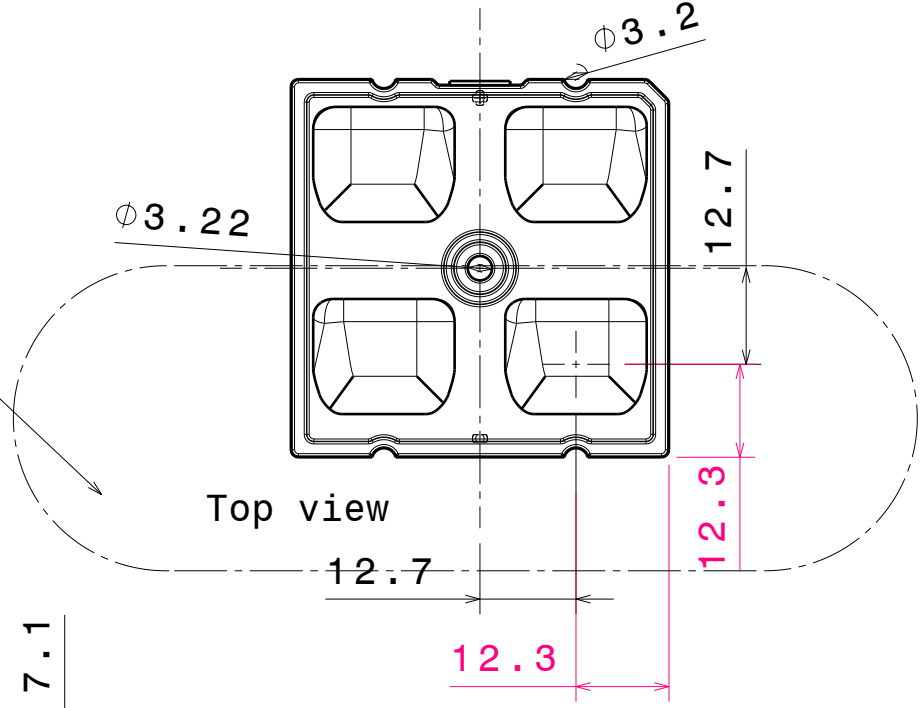

Top view

2

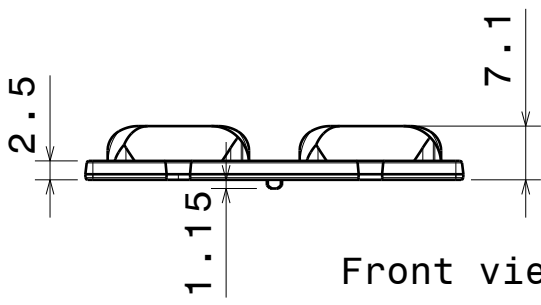

Front view

4

3

2

INDEX	PART NO	DESCRIPTION	MATERIAL	COLOUR
1	C13299	STRADA-2X2-ME	PMMA 8N	TRANSPARENT

Tolerances if not otherwise shown
According to DIN ISO 2768-1
Linear measures:
Up to 30mm class M, otherwise class C.
According to DIN ISO 2768-2
Form and position: class L

LEDiL LediL Oy
Salorankatu 10
FIN 24240 SALO
Finland

THIRD ANGLE PROJECTION:

DRAWING TITLE
C13299_STRADA-2X2-ME

This drawing is the property of LEDiL Oy. It may not be reproduced, copied or communicated without a written agreement with LEDiL Oy."

SIZE	PART NUMBER
A4	C13299

SCALE	1:1	WEIGHT	SHEET	1/1
-------	-----	--------	-------	-----

1

1

D A

Luminaire: LEDiL Oy C13299_STRADA-2X2-ME_(XT-E)_3 Eff.94.0%
Lamps: 1 x CREE_XT-E_385.199lm@250mA_CCT=5717K

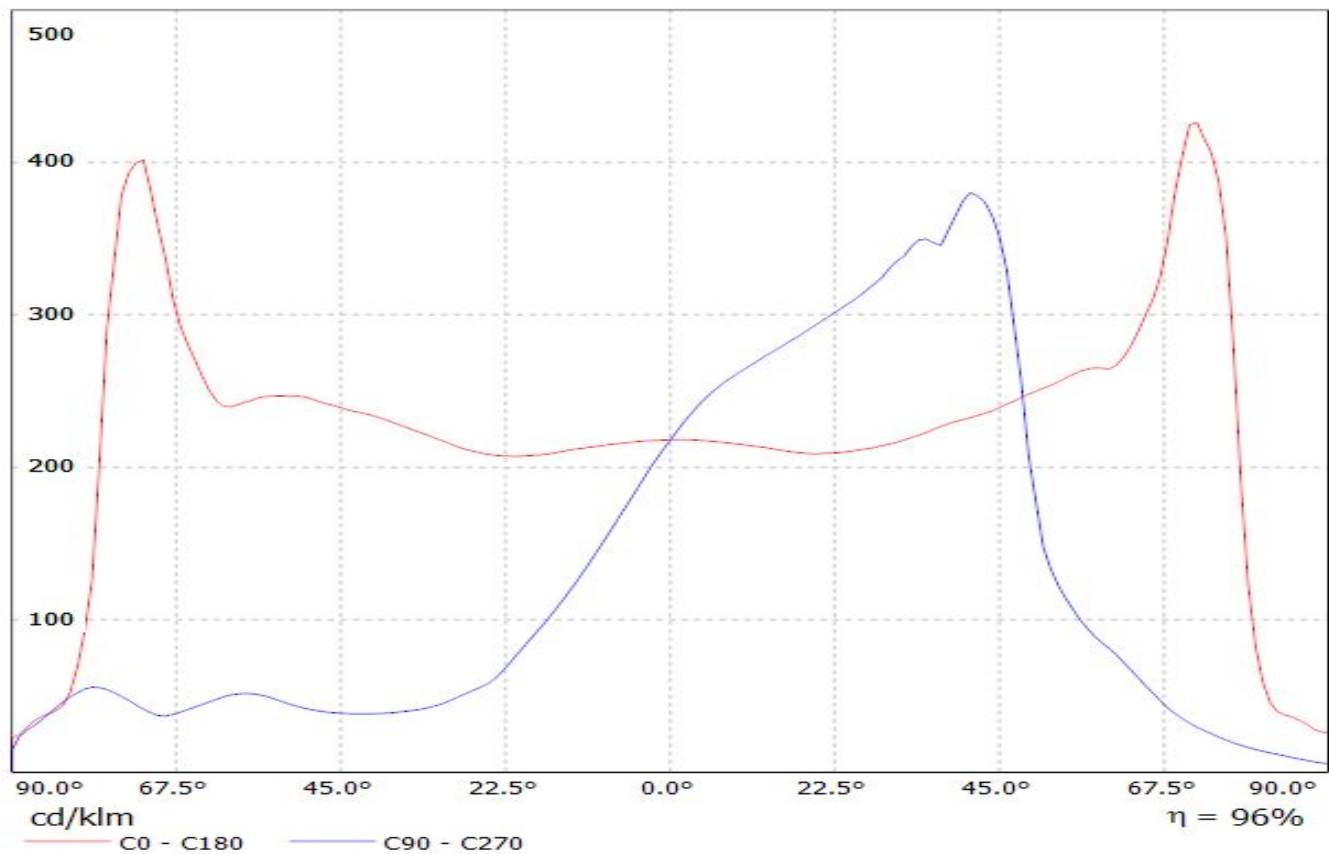

LEDiL Oy C13299_STRADA-2X2-ME_(XM-L) Eff.94.0% / LDC (Linear)

Luminaire: LEDiL Oy C13299_STRADA-2X2-ME_(XM-L) Eff.94.0%
Lamps: 1 x XM-L_2x2_360.4lm@250mA_P=2.82462W_I=249.9mA

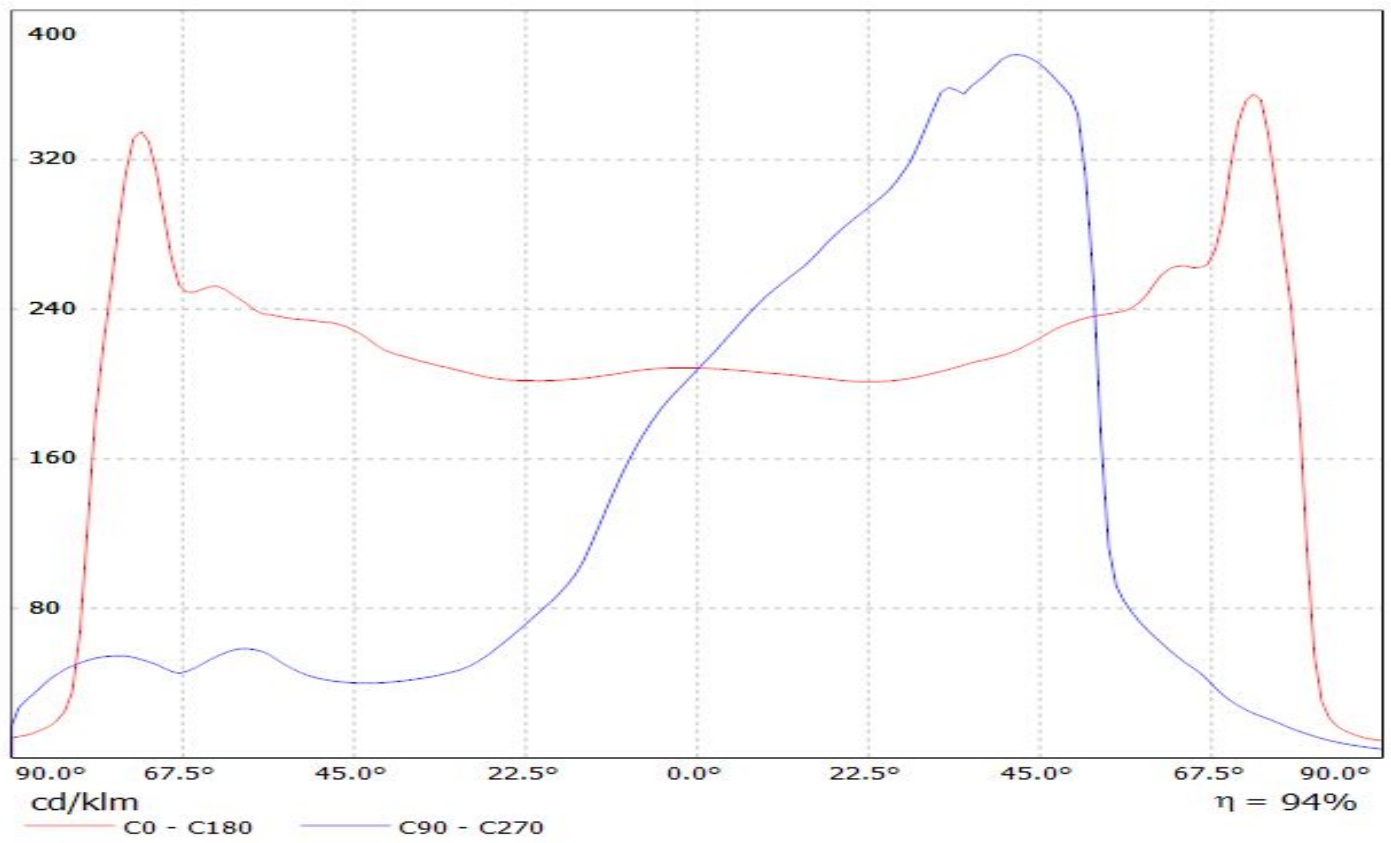

LEDiL Oy C13299_STRADA-2X2-ME_(N383) Eff.94.0% / LDC (Linear)

Luminaire: LEDiL Oy C13299_STRADA-2X2-ME_(N383) Eff.94.0%

Lamps: 1 x NICHIA_N383_2x2_(NS9W383T)_376.958lm@250mA_P=2.88194W_I=249.9mA

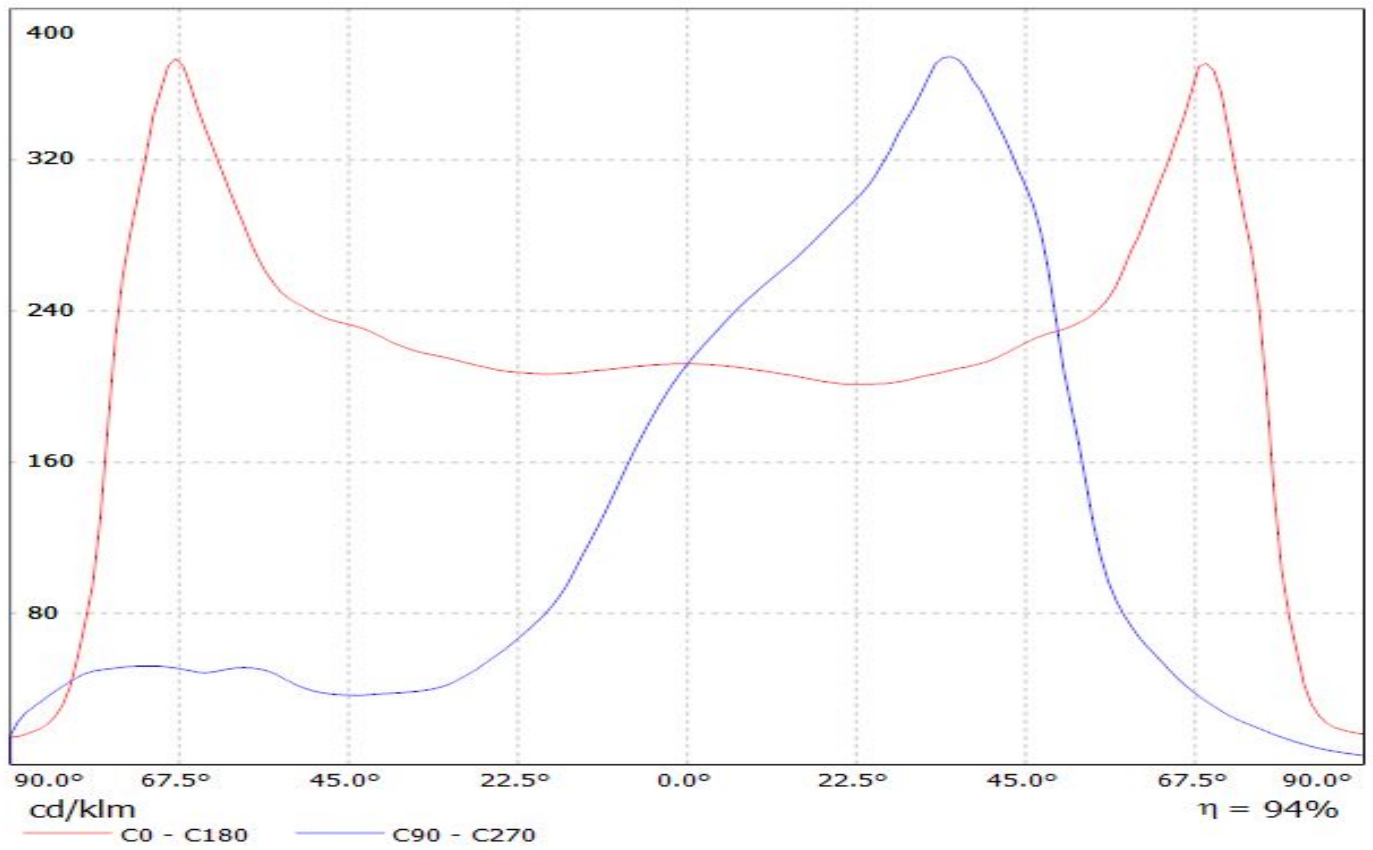

LEDiL Oy C13299_STRADA-2X2-ME_(XB-D) Eff.94.0% / LDC (Linear)

Luminaire: LEDiL Oy C13299_STRADA-2X2-ME_(XB-D) Eff.94.0%
Lamps: 1 x XB-D_2x2_368.85lm@250mA_P=3.06227W_I=249.9mA

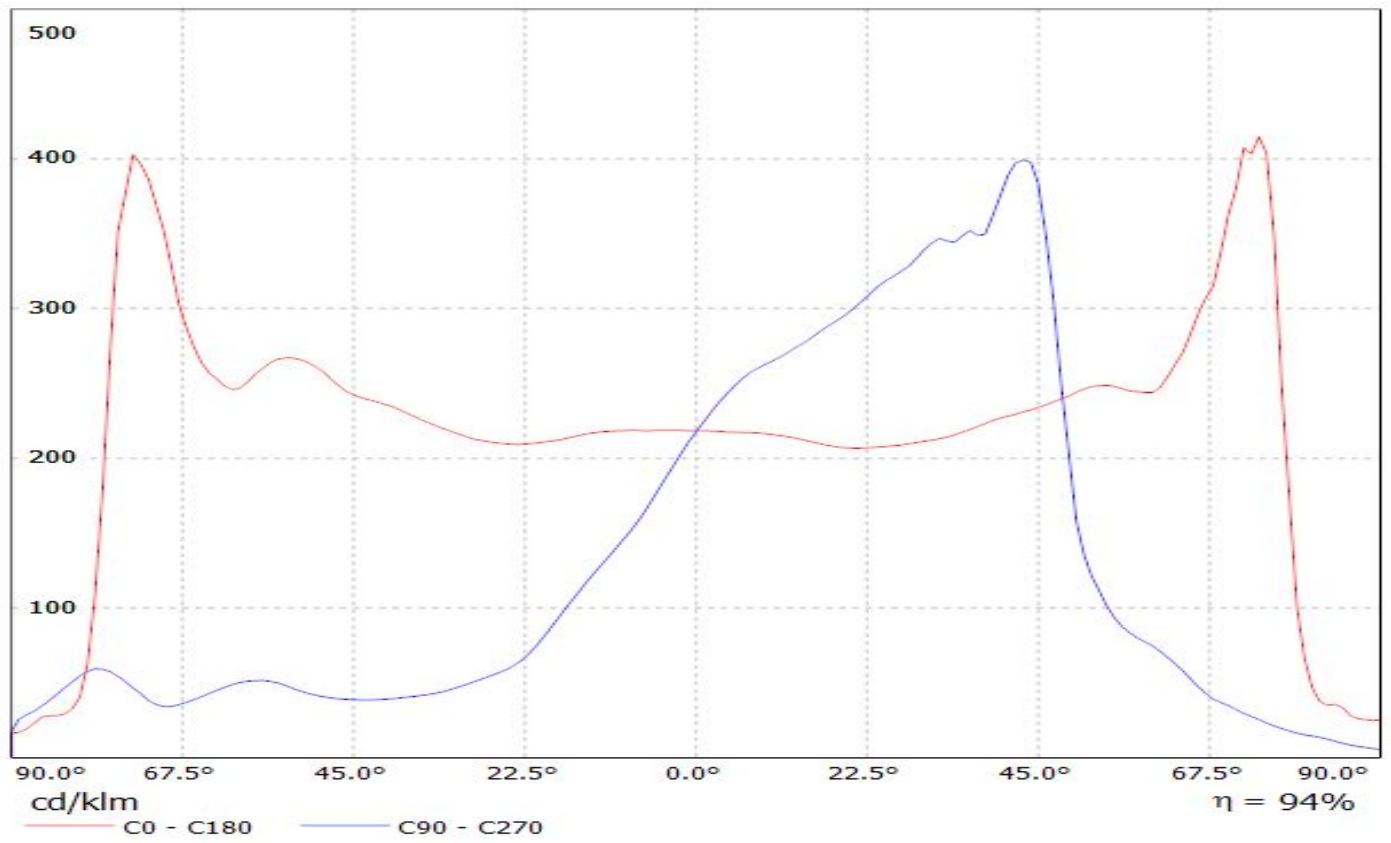

LEDiL Oy C13299_STRADA-2X2-ME_(XP-G2) Eff.94.0% / LDC (Linear)

Luminaire: LEDiL Oy C13299_STRADA-2X2-ME_(XP-G2) Eff.94.0%
Lamps: 1 x XP-G2_2x2_(XPGBWT-L1-000-00G51)
_418.9lm@250mA_CCT=7181K_P=2.93358W_I=249.9mA

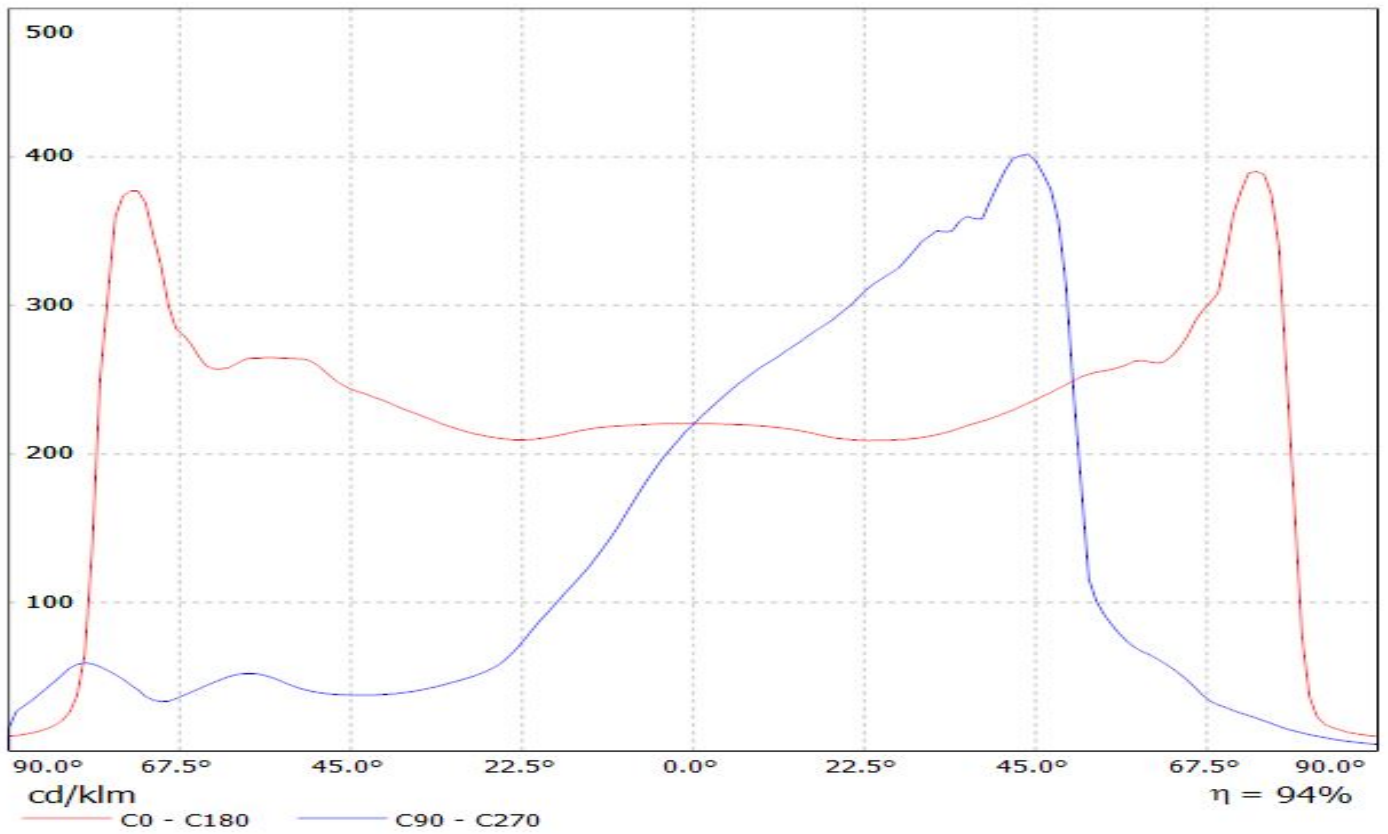

LEDiL Oy C13299_STRADA-2X2-ME_(XP-G) / LDC (Linear)

Luminaire: LEDiL Oy C13299_STRADA-2X2-ME_(XP-G)
Lamps: 1 x XP-G_2x2_258.35lm@250mA_P=2.88734W_I=249.9mA

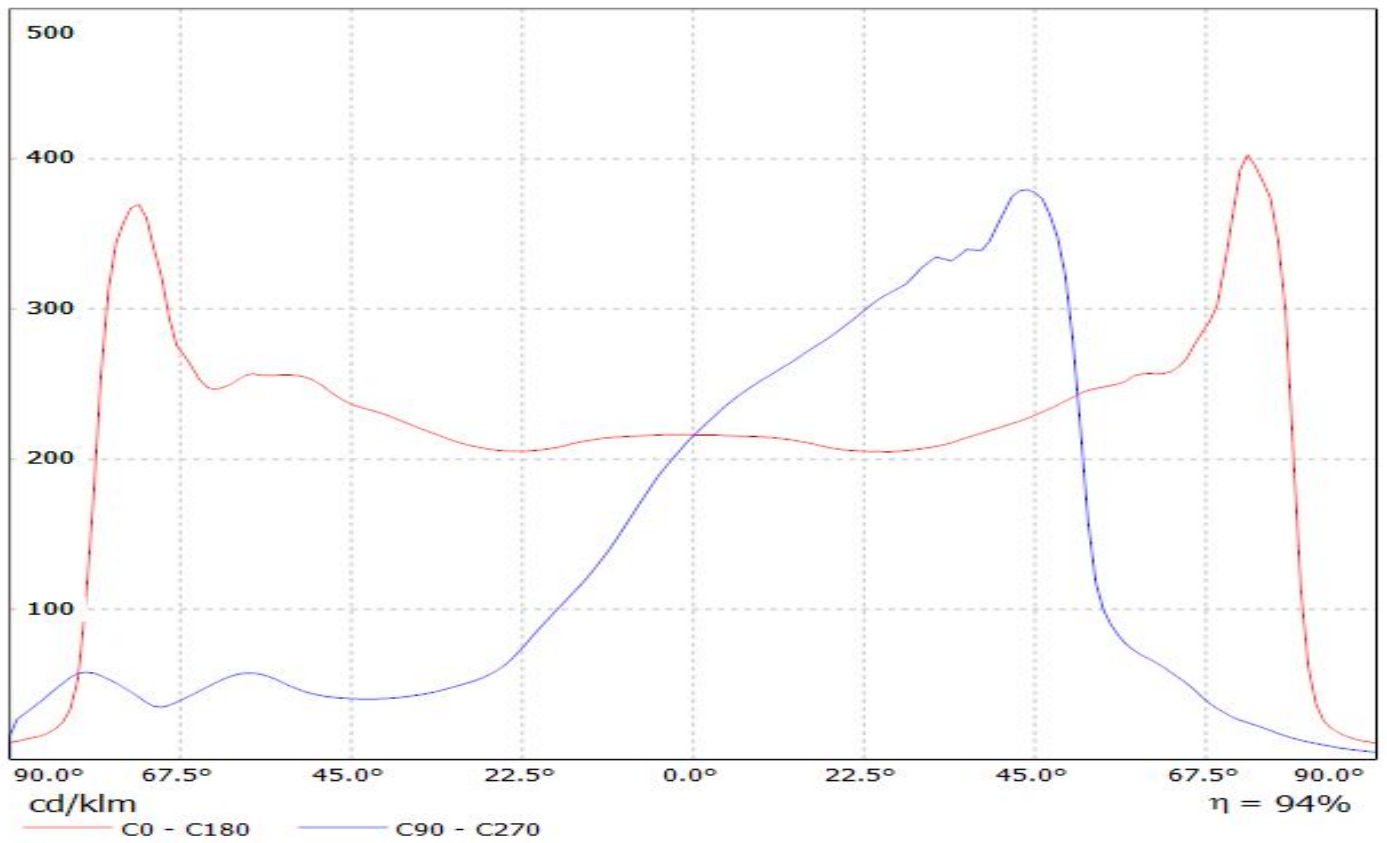

LEDiL Oy C13299_STRADA-2X2-ME_(SQ-PC) Eff.94.0% / LDC (Linear)

Luminaire: LEDiL Oy C13299_STRADA-2X2-ME_(SQ-PC) Eff.94.0%

Lamps: 1 x SQ-PC_2x2_(LCW-CQAR.PC-MSMU-5H71-1)_400.75lm@250mA_CCT=?

K_P=2.96681W_J=249.9mA

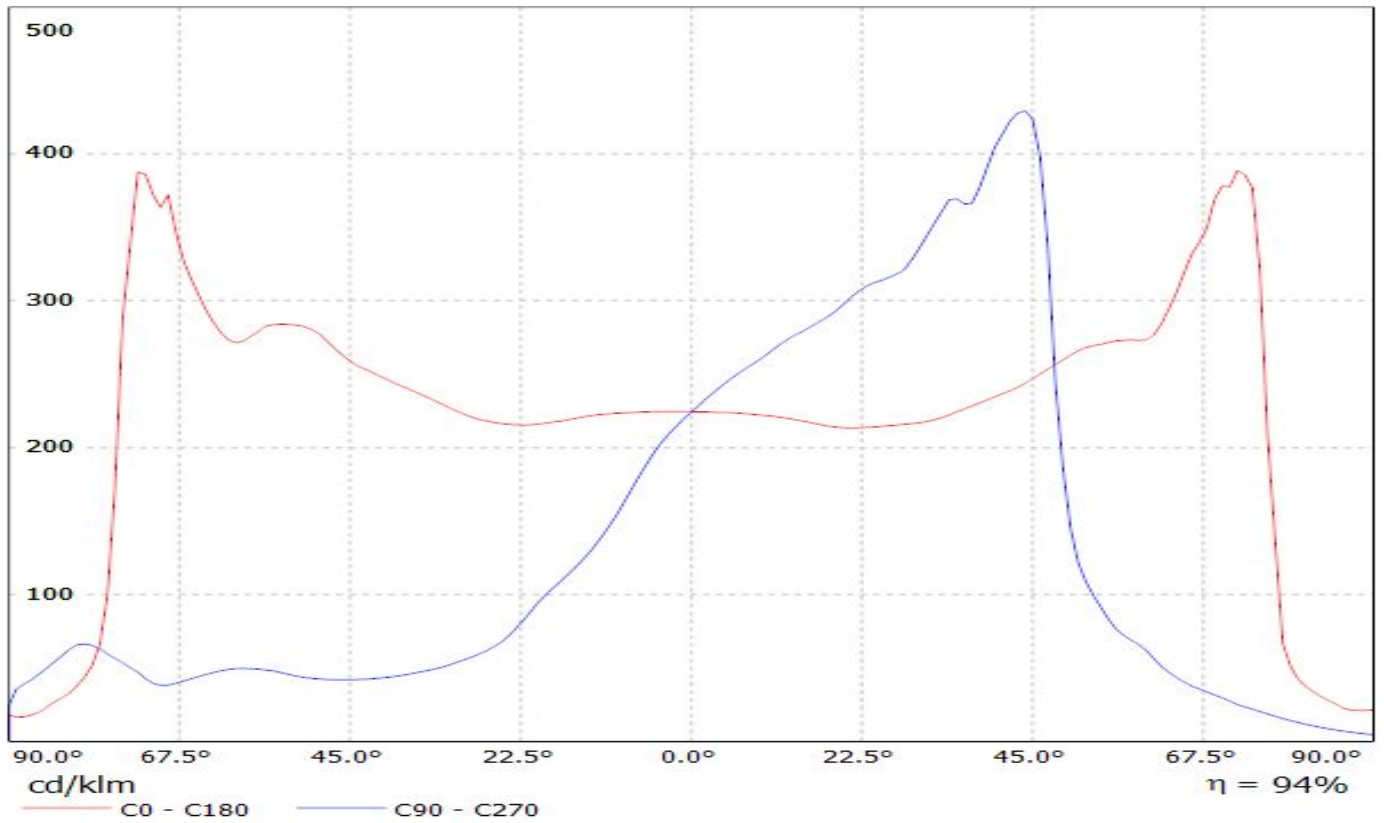

LEDiL Oy C13299_STRADA-2X2-ME_(Luxeon-R) Eff.94.0% / LDC (Linear)

Luminaire: LEDiL Oy C13299_STRADA-2X2-ME_(Luxeon-R) Eff.94.0%

Lamps: 1 x Luxeon_R_2x2_(LXA7-PW30)_314.75lm@250mA_P=2.77914W_I=249.9mA

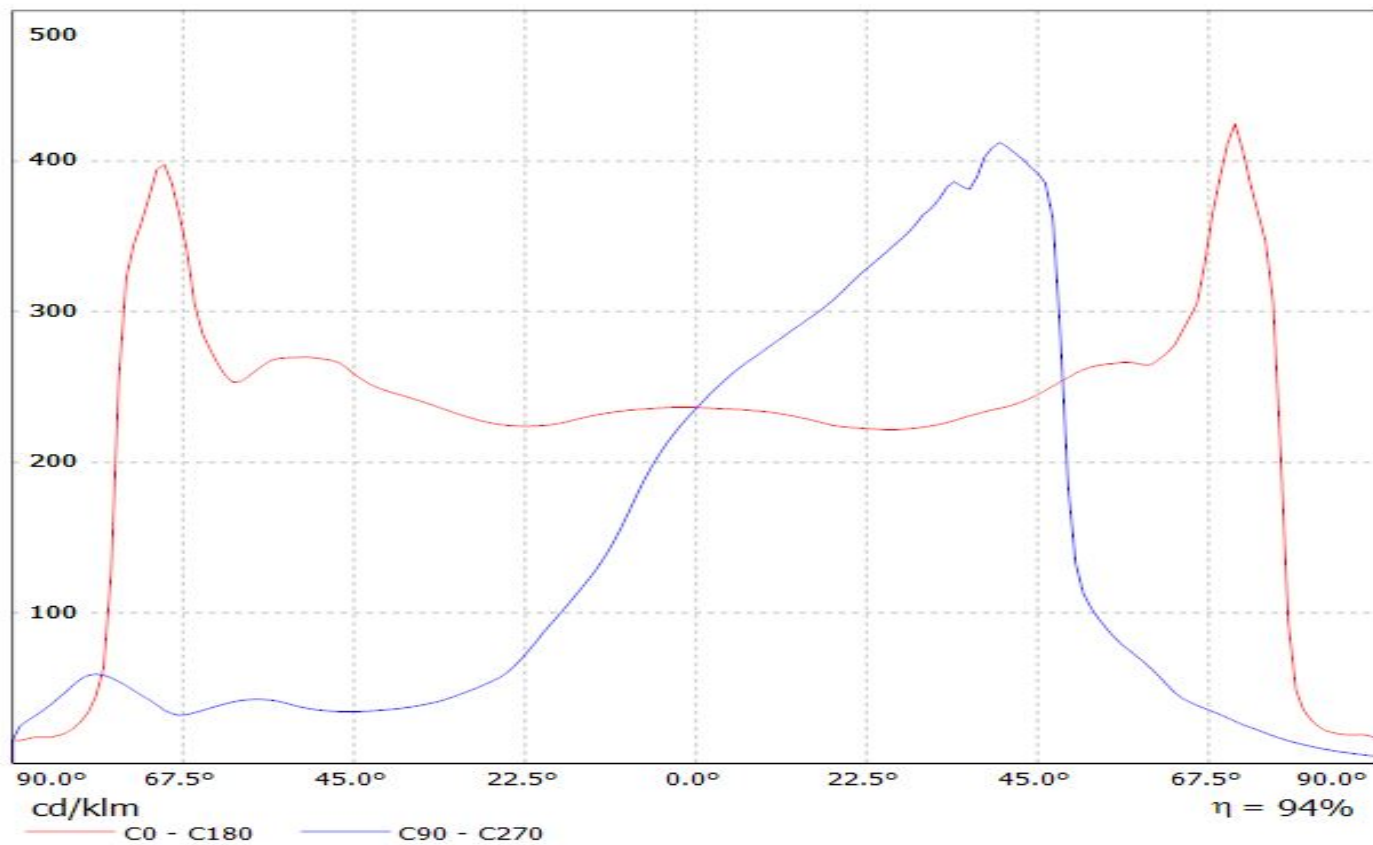

LEDiL Oy C13299_STRADA-2X2-ME_(Rebel-ES) Eff.94.0% / LDC (Linear)

Luminaire: LEDiL Oy C13299_STRADA-2X2-ME_(Rebel-ES) Eff.94.0%
Lamps: 1 x Luxeon_Rebel-ES_2x2_341.5lm@250mA_P=2.86485W_I=249.9mA

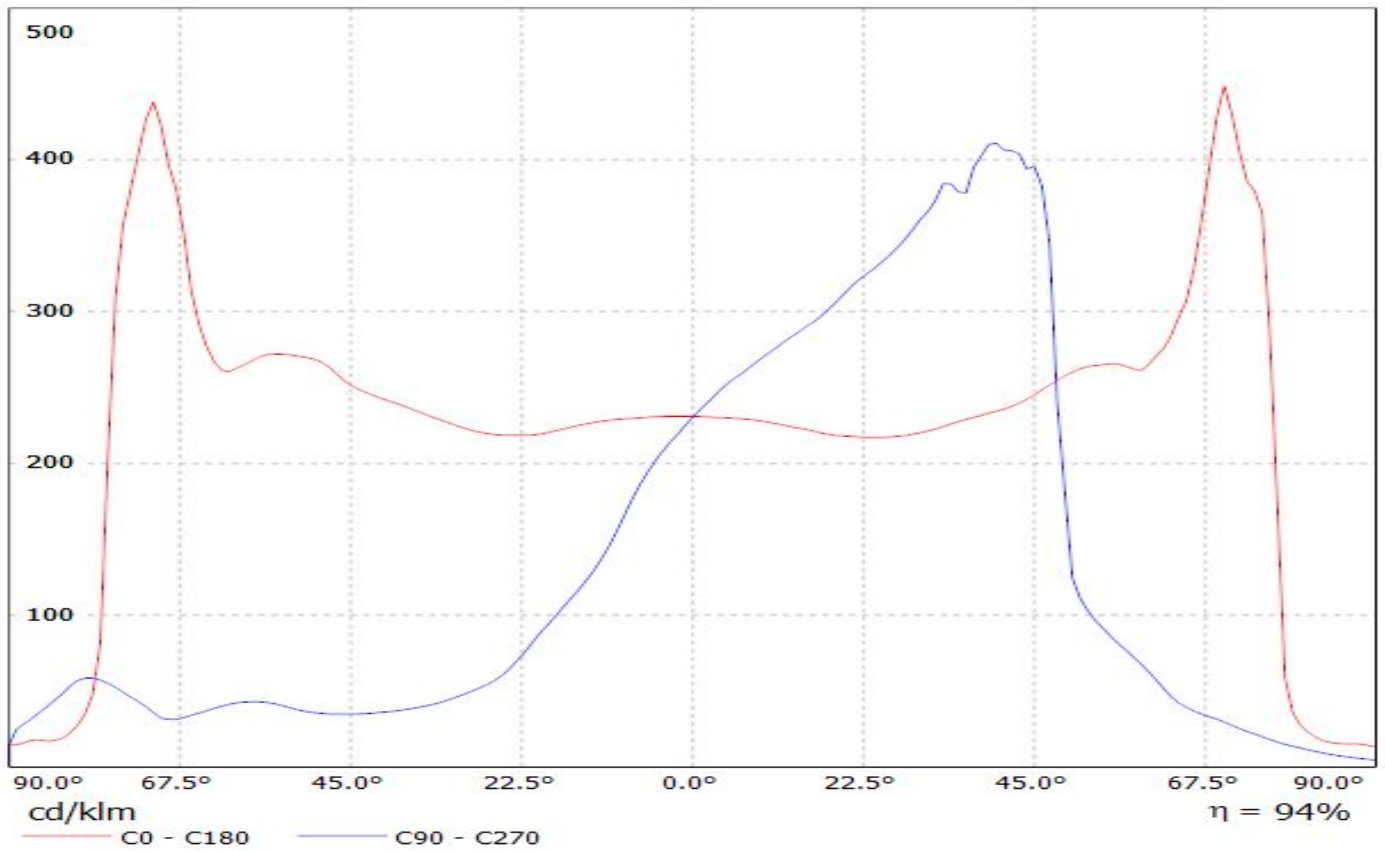

Luminaire: LEDiL Oy C13299_STRADA-2x2-ME_(Luxeon_T)
Lamps: 1 x Luxeon T (LXH8-FW30-3) 303lm@250mA P=2.80138W I=0.2499A

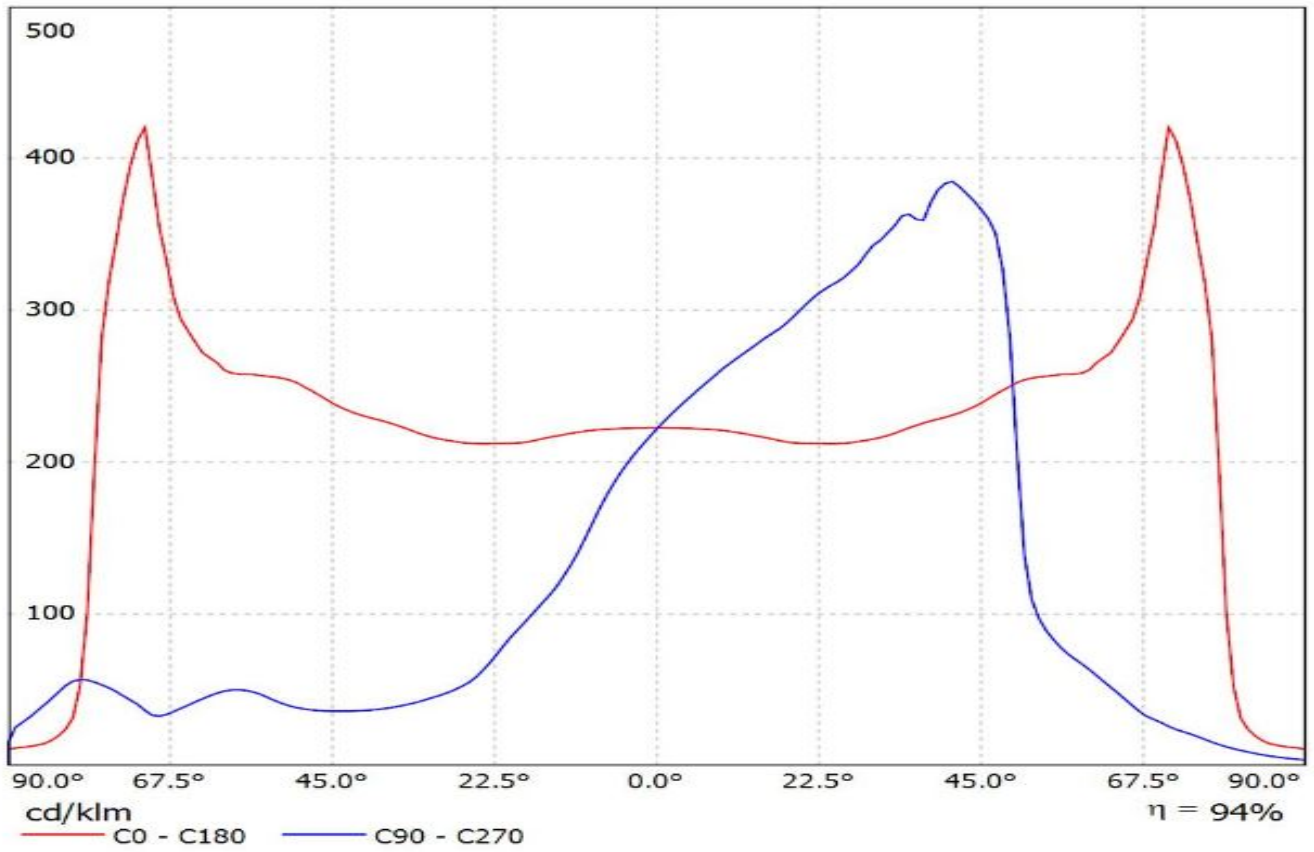

LEDiL Oy C13299_STRADA-2X2-ME_(Z5P) Eff.94.0% / LDC (Linear)

Luminaire: LEDiL Oy C13299_STRADA-2X2-ME_(Z5P) Eff.94.0%
Lamps: 1 x Seoul_Z5P_2x2_290.05lm@250mA_P=3.6208W_I=249.9mA

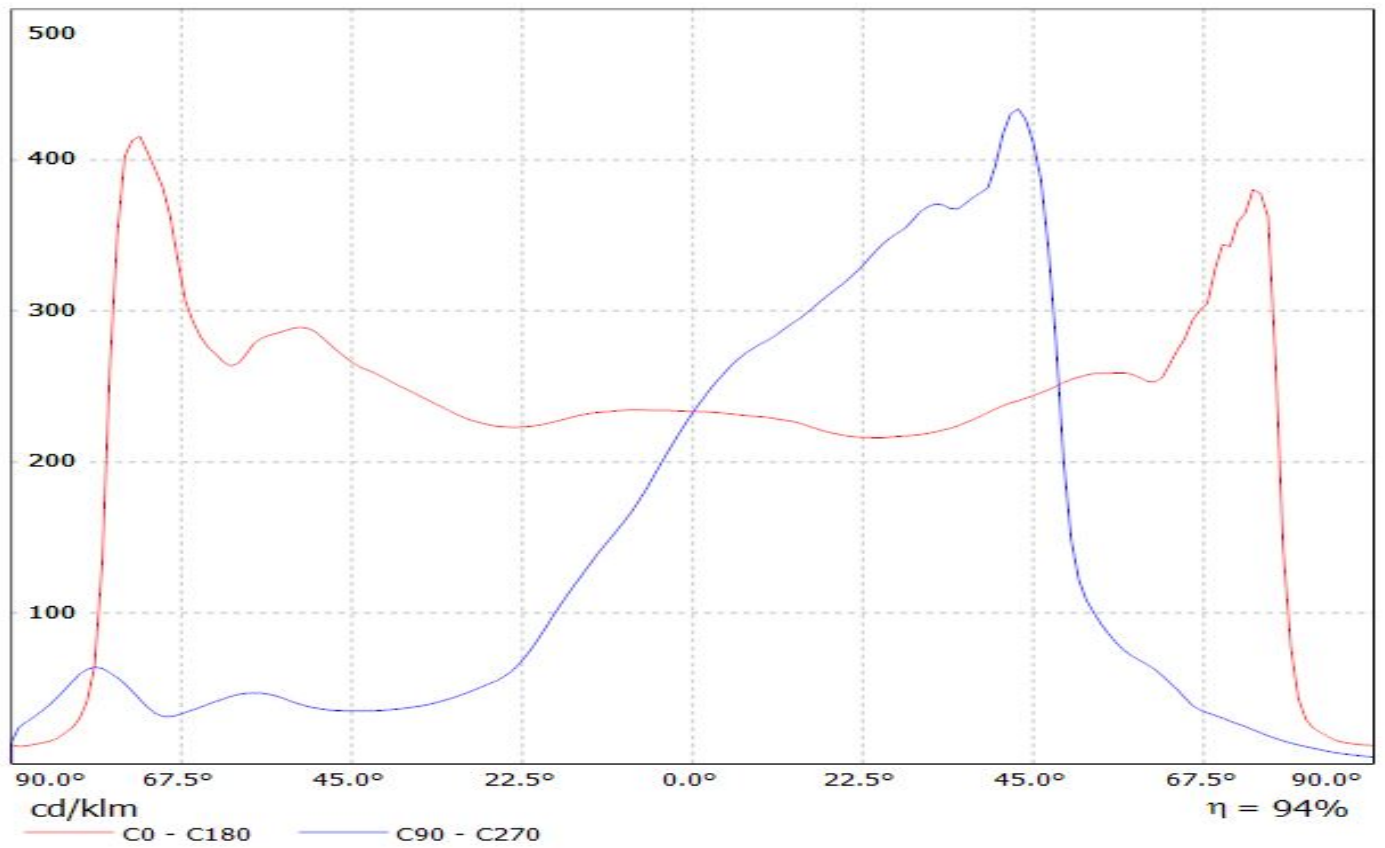

Luminaire: LEDiL Oy C13299_STRADA-2x2-ME_(MJT4040) Eff. 94%
Lamps: 1 x SEOUL ACHRICH MJT4040 (SAW09H0A) 255lm@40mA P=2.37W I=40mA

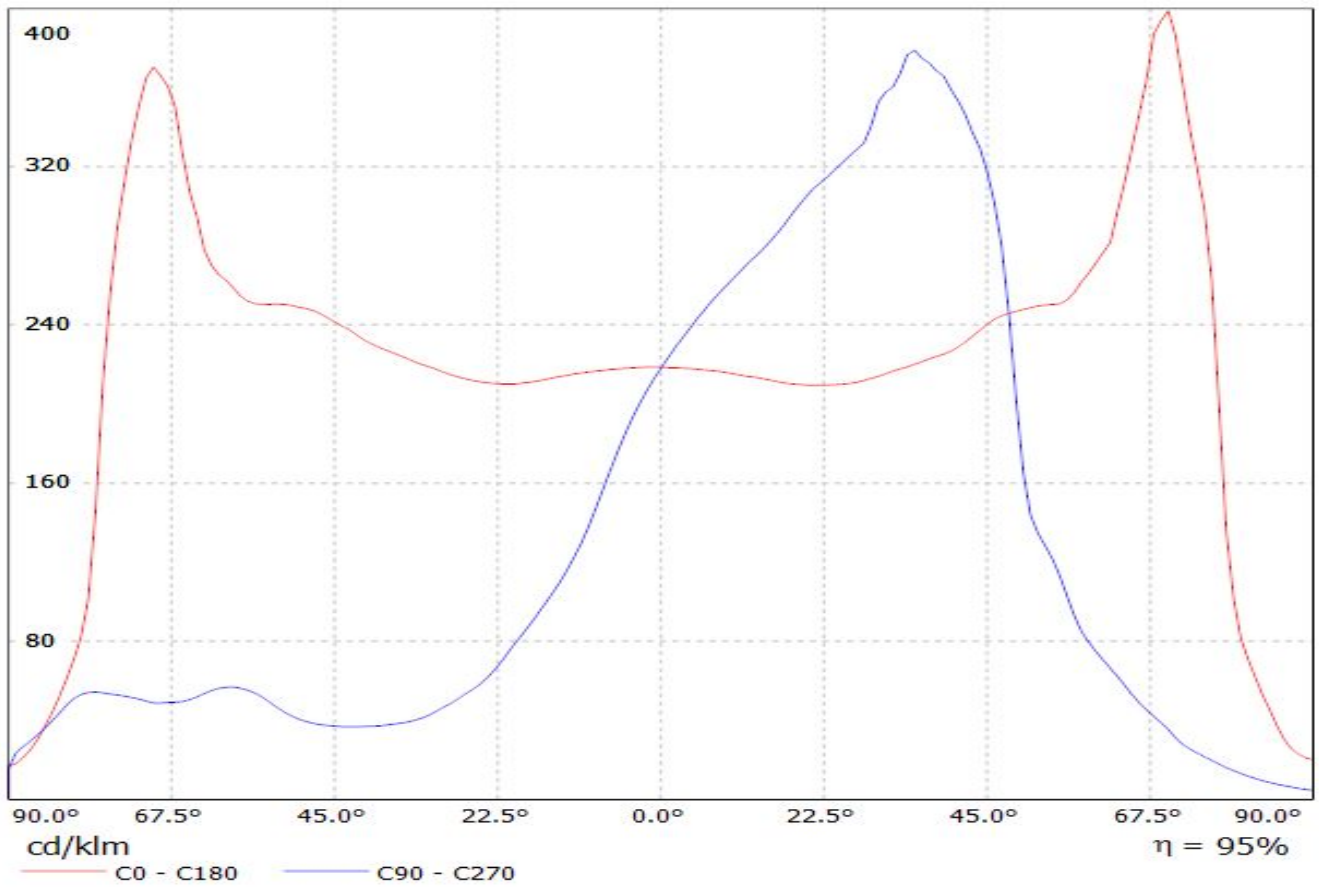

**LEDiL Oy C13299_STRADA-2X2-ME_(LG-3535-CERAMIC-GEN2) Eff.94.0% /
LDC (Linear)**

Luminaire: LEDiL Oy C13299_STRADA-2X2-ME_(LG-3535-CERAMIC-GEN2) Eff.94.0%
Lamps: 1 x LG-3535-CERAMIC-GEN2_2x2_475.9lm@250mA_P=2.8651W_CCT=6562K_I=249.9mA

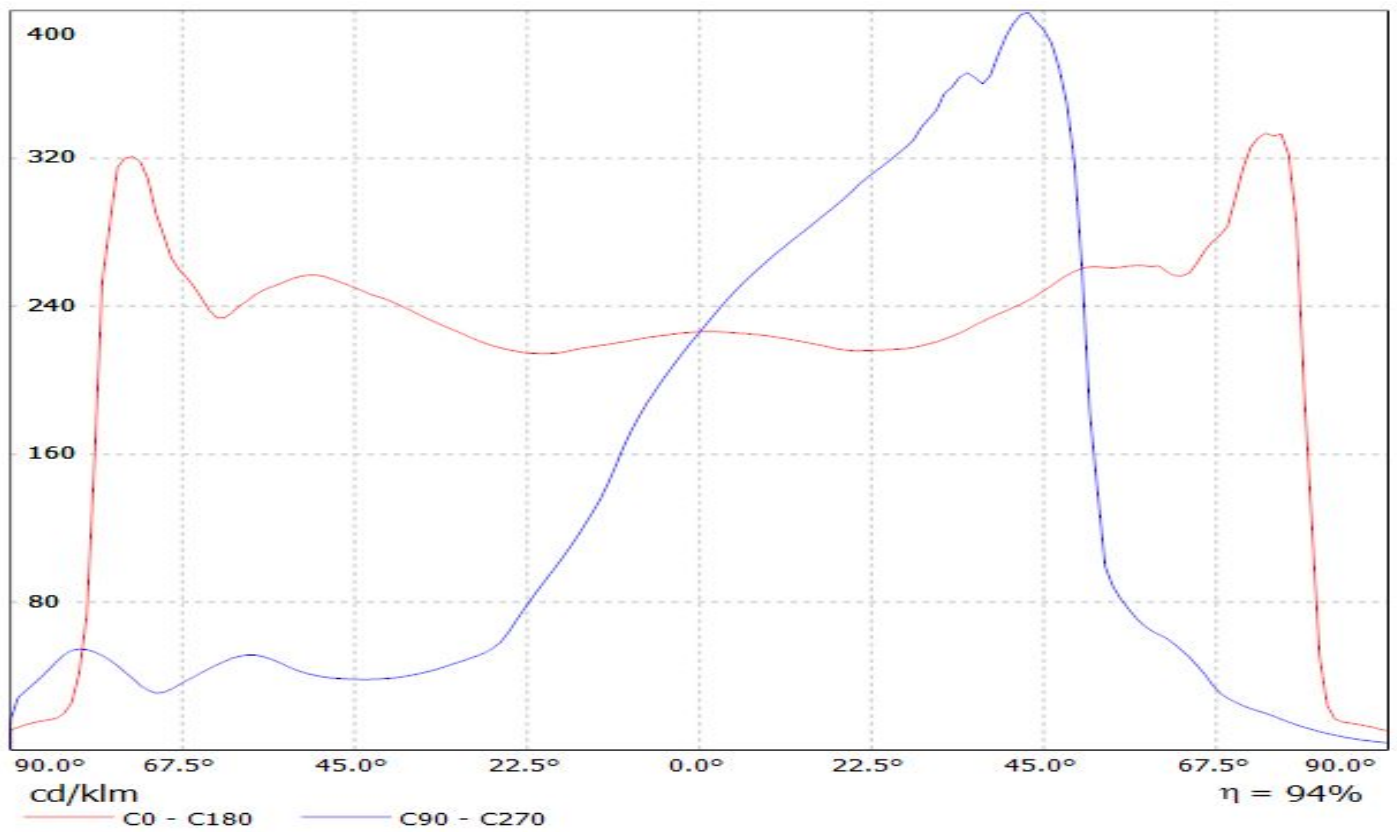

Luminaire: LEDiL Oy C13299_STRADA-2x2-ME_(Luxeon_Z_ES) Eff. 94%
Lamps: 1 x Luxeon_Z_ES_2x2_(LXZ2-3090)_210.126lm@250mA_P=2.81862W_I=249.9mA

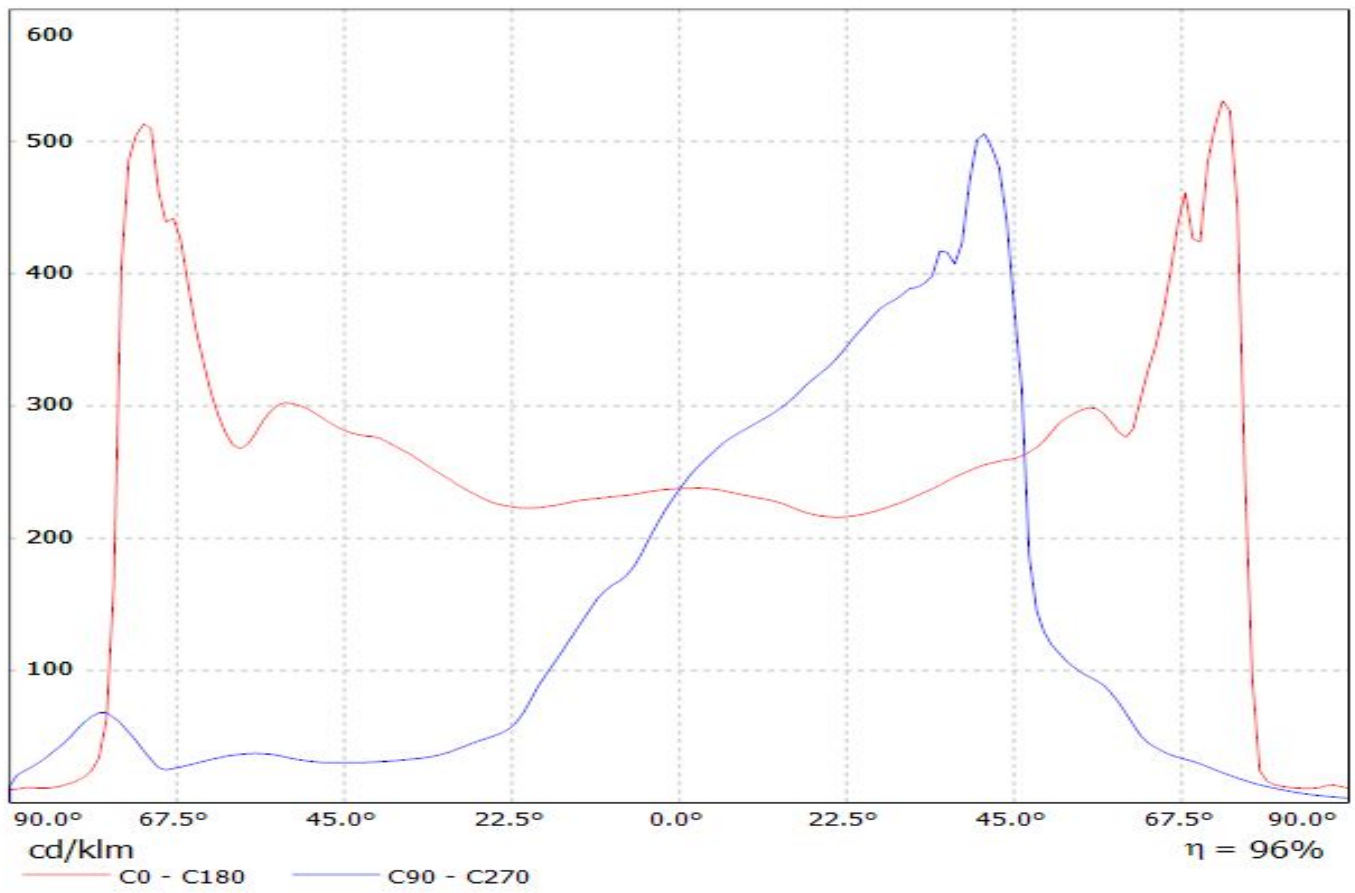

LEDiL Oy C13299_STRADA-2X2-ME_(XP-E2) Eff.94.0% / LDC (Linear)

Luminaire: LEDiL Oy C13299_STRADA-2X2-ME_(XP-E2) Eff.94.0%

Lamps: 1 x CREE_XP-E2_2x2_(XPEBWT-L1-7B4-Q4-0-01)

_341.05lm@250mA_P=2.92366W_I=249.8mA

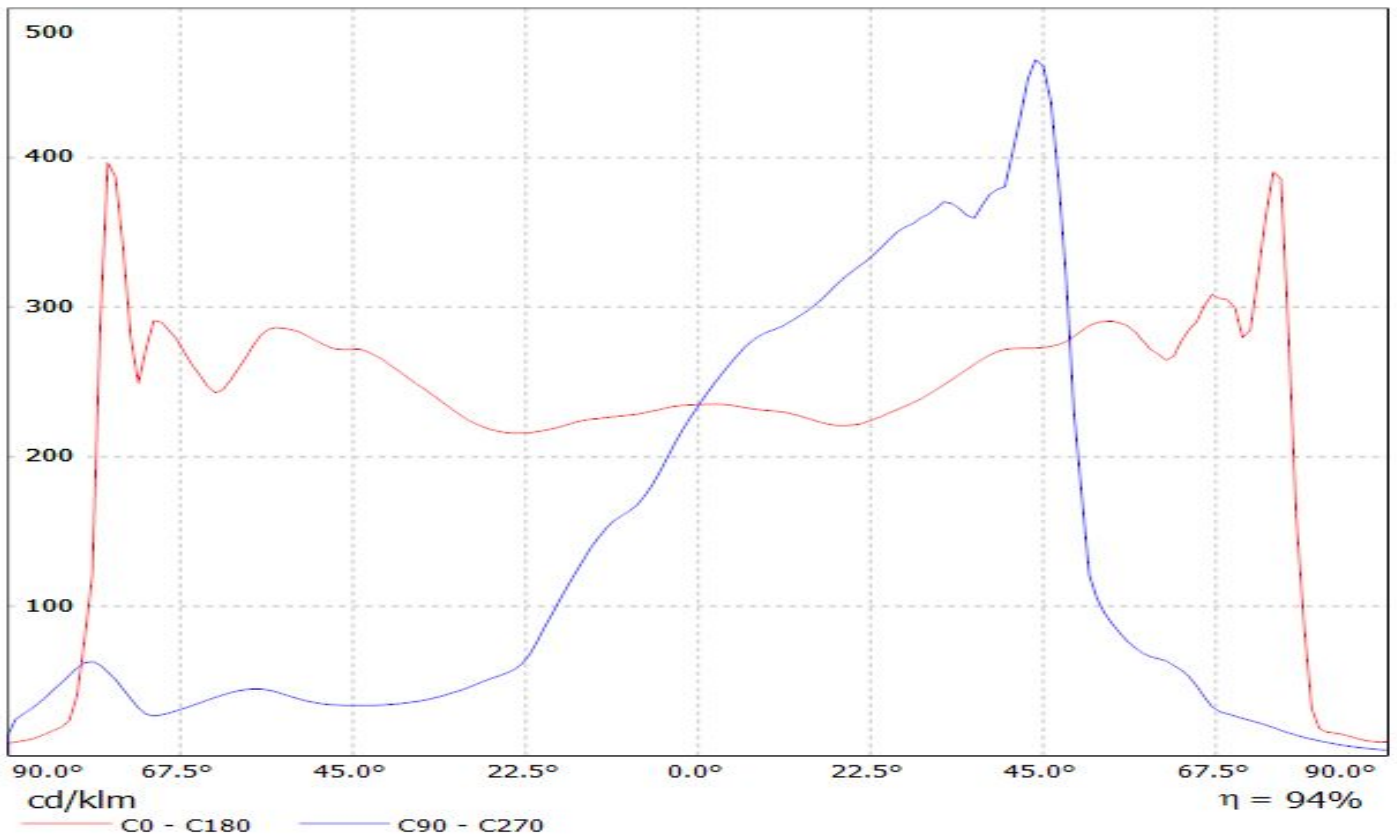

LEDiL Oy C13299_STRADA-2X2-ME_(Z5M) Eff.94.0% / LDC (Linear)

Luminaire: LEDiL Oy C13299_STRADA-2X2-ME_(Z5M) Eff.94.0%

Lamps: 1 x SEOUL_Z5M_(SZ5-M0-W0-00)_364.5lm@250mA_P=2.95788W_I=249.8mA

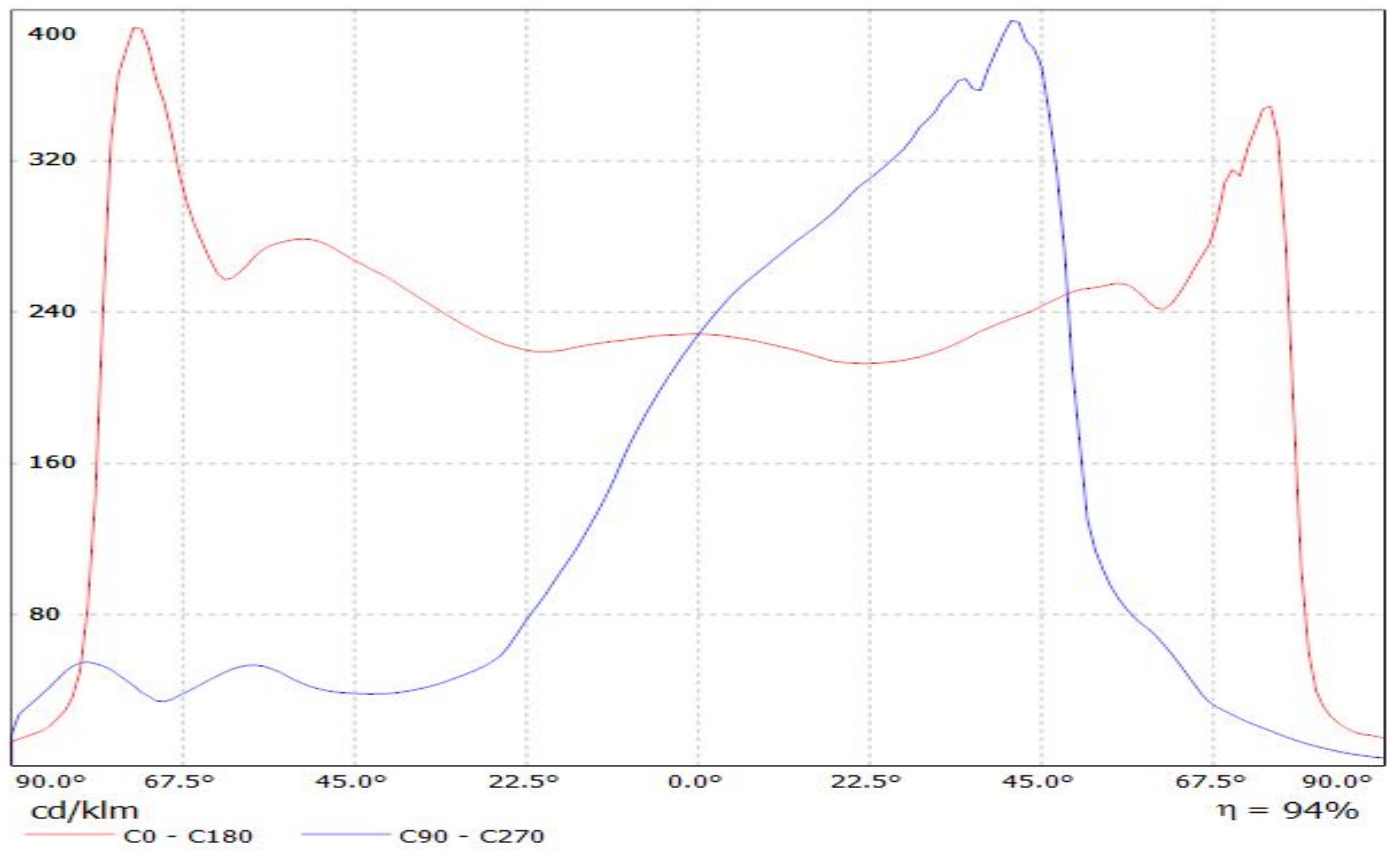

Luminaire: LEDiL Oy C13299_STRADA-2X2-ME_(LUXEON_Q)
Lamps: 1 x LUXEON_Q_2x2_(LHQ-3080)_298.615lm@250mA_P=2.86995W_I=249.8mA

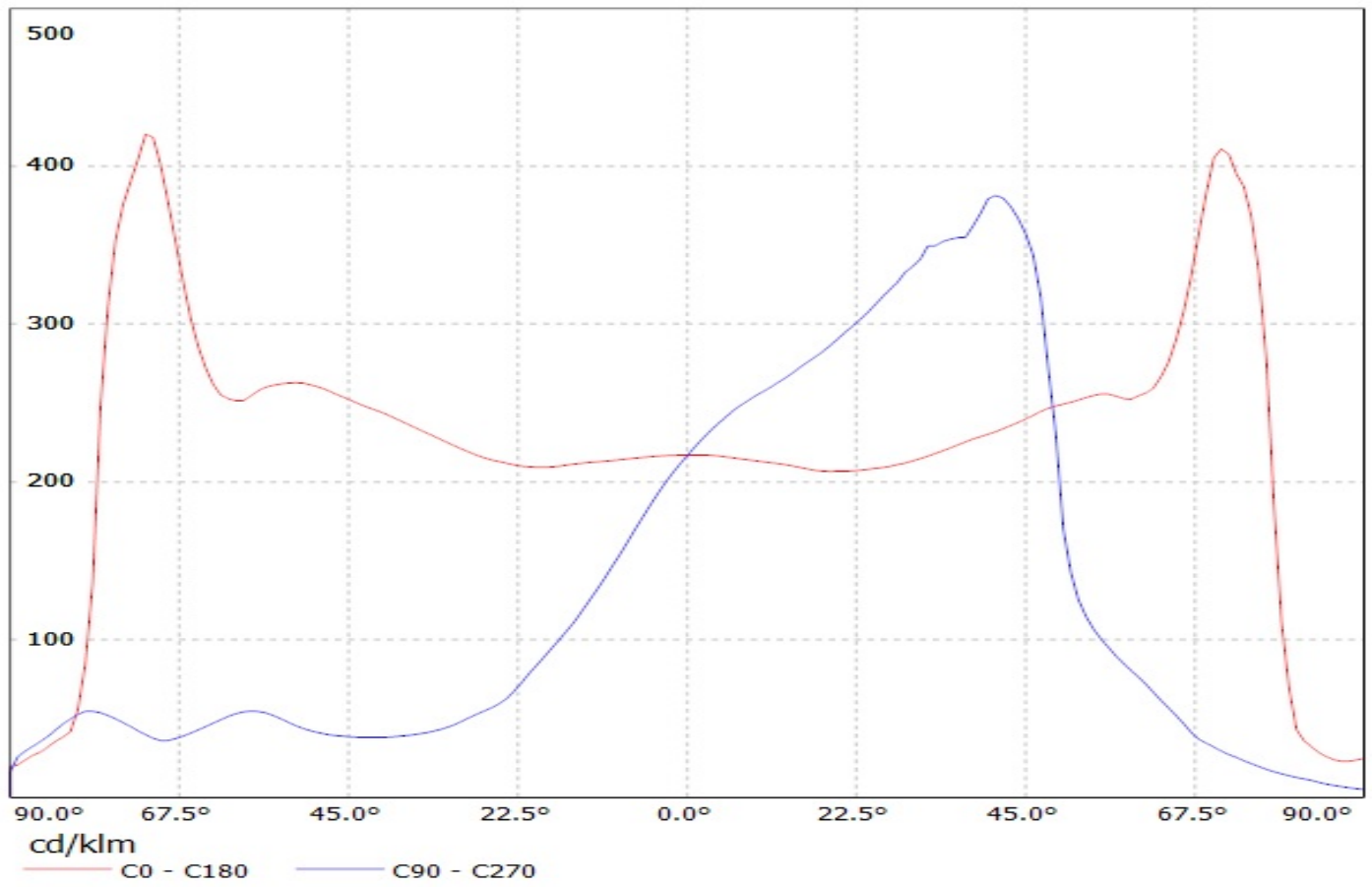

Luminaire: LEDil Oy C13299_STRADA-2X2-ME_(Z5M1) Efficiency=94%
Lamps: 1 x Seoul Z5M1 (SZ5-M1-WN-C8) 379lm @ 250mA CCT=4600K P=2.9W I=250mA

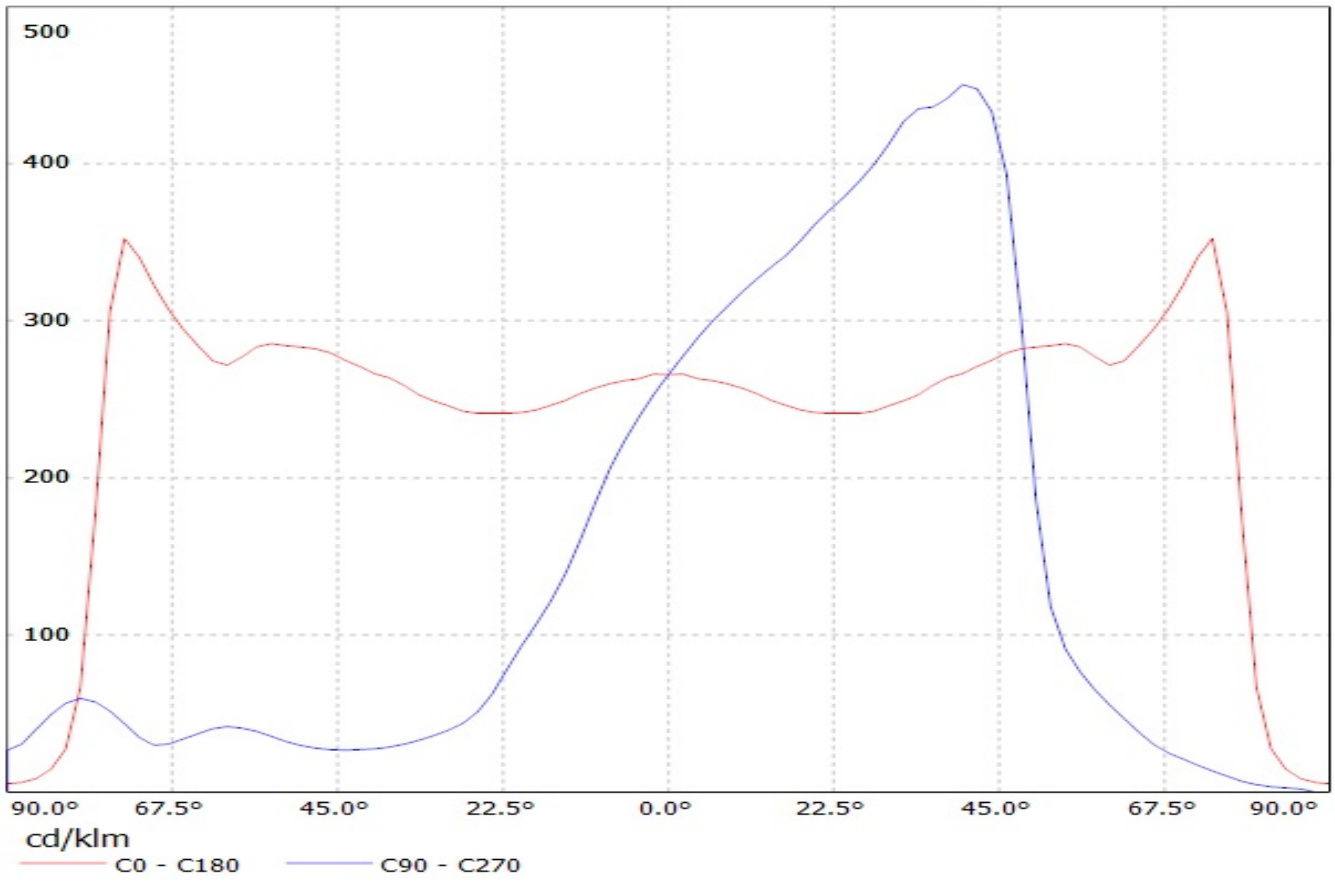

Luminaire: LEDil Oy C13299_STRADA-2X2-ME_(XM-L2) Efficiency=94%
Lamps: 1 x Cree XM-L2 (XMLBWT-0-7B4-T30-0L-0001) 356lm @ 250mA CCT=3200K P=2.8W I=250mA

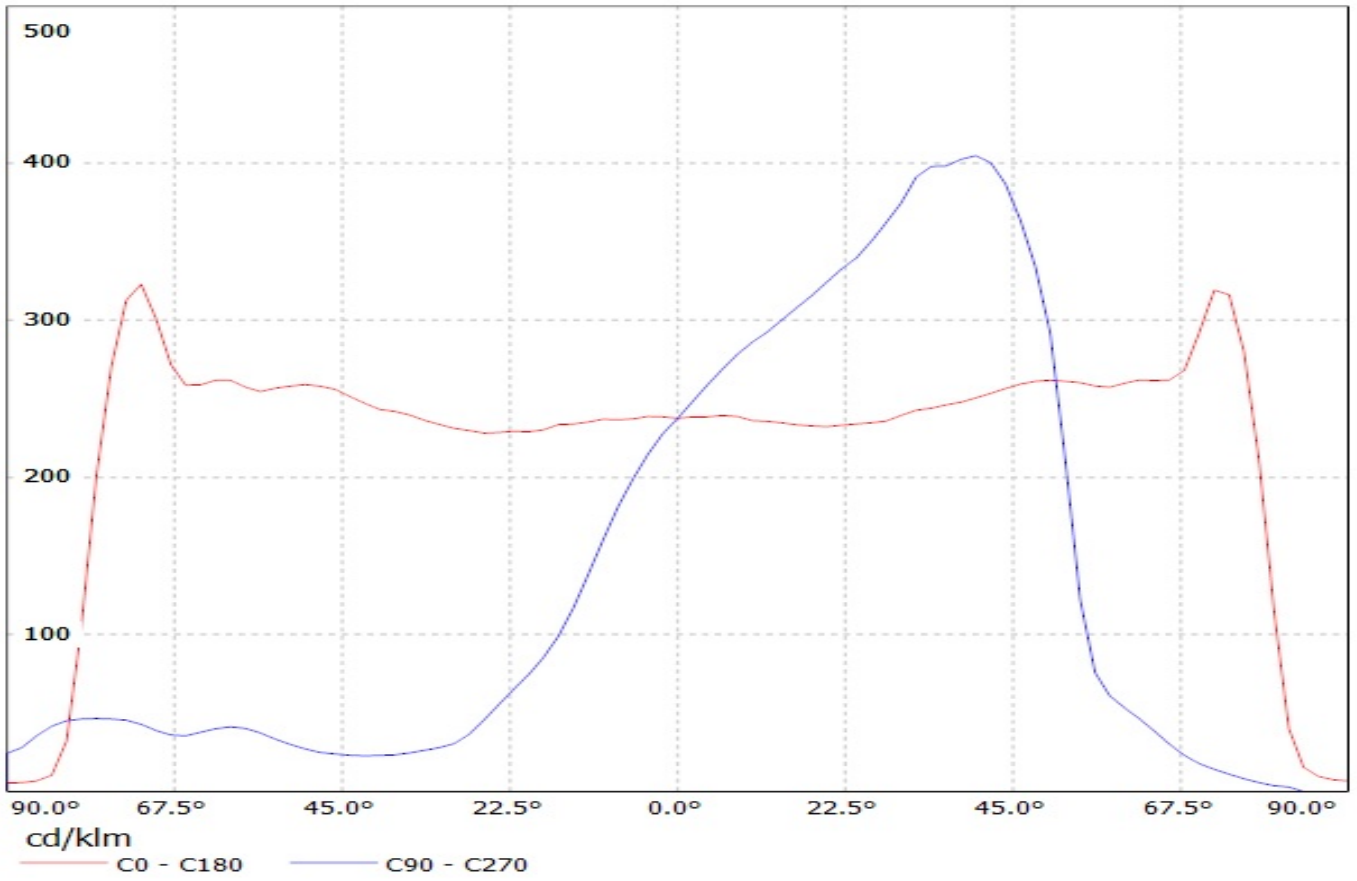

Luminaire: LEDiL Oy C13299_STRADA-2X2-ME_(XP-L)

Lamps: 1 x CREE_XP-L_2x2_(XPLAWT-0-1B0-V40-00-0001)_518.95lm@250mA_CCT=7600K_P=2.79963W_I=249.9mA

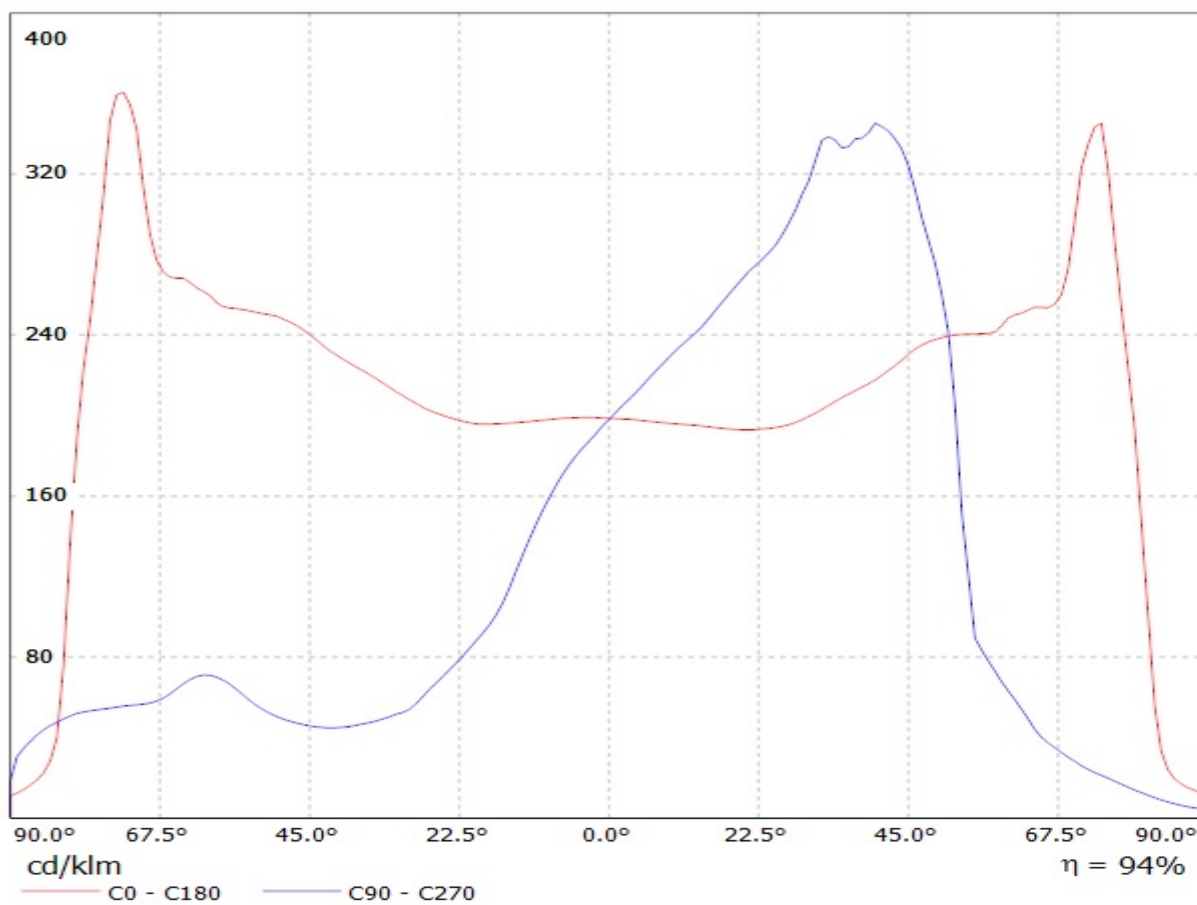

Luminaire: LEDiL Oy C13299_STRADA-2X2-ME_(LUXEON_MZ) Eff.94.0%
Lamps: 1 x LUXEON_MZ_2x2_(LMZ7-QW57)_419.8lm@250mA_P=2.71916W_CCT=5700K_I=249.9mA

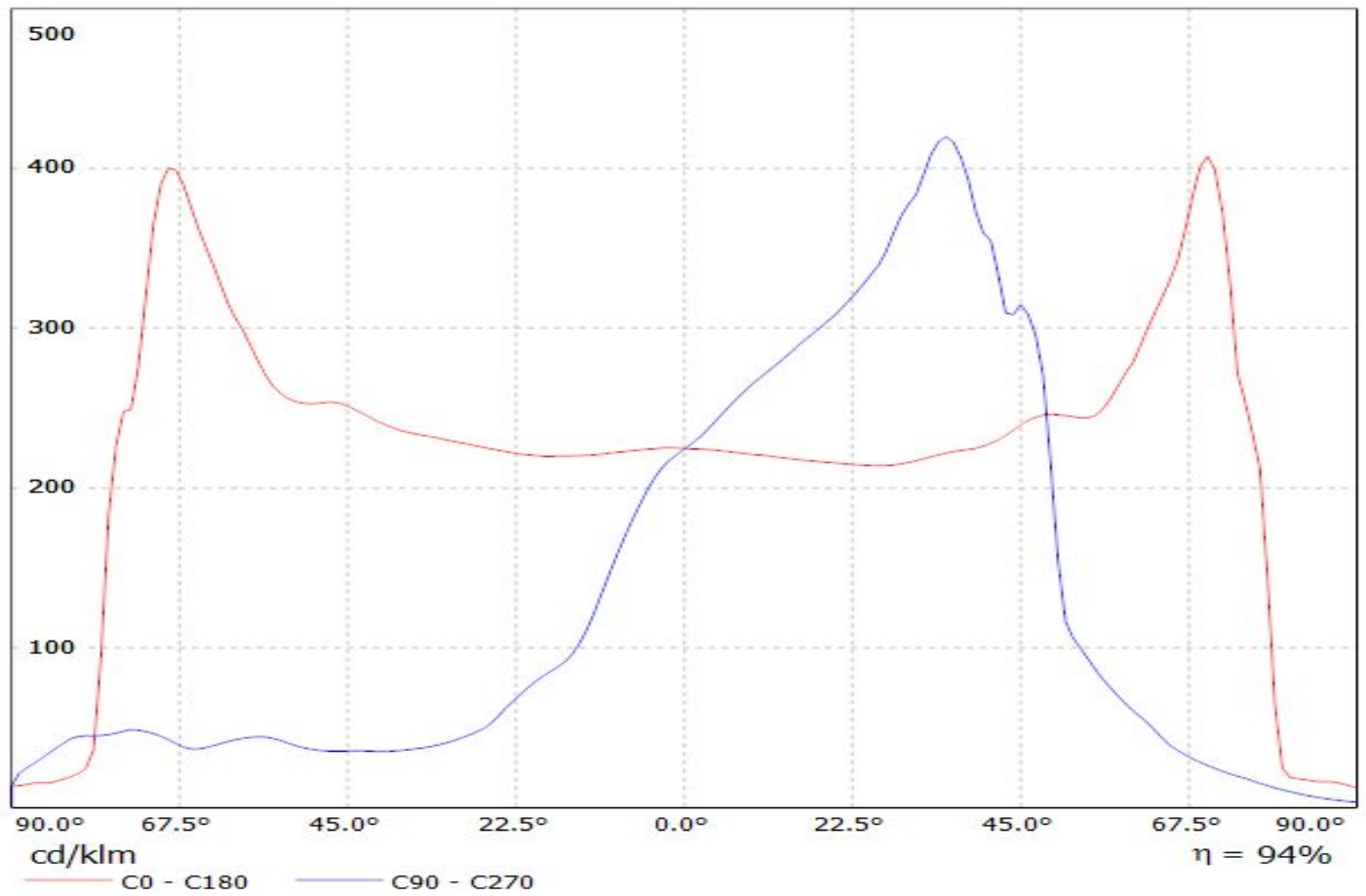

Luminaire: LEDiL Oy C13299_STRADA-2x2-ME_(NVSxx19B)

Lamps: 1 x Nichia_NVsxx19B_2x2_(NVSL219BE)_310.219lm@250mA_CCT=3071K_P=2.87735W_I=249.9mA

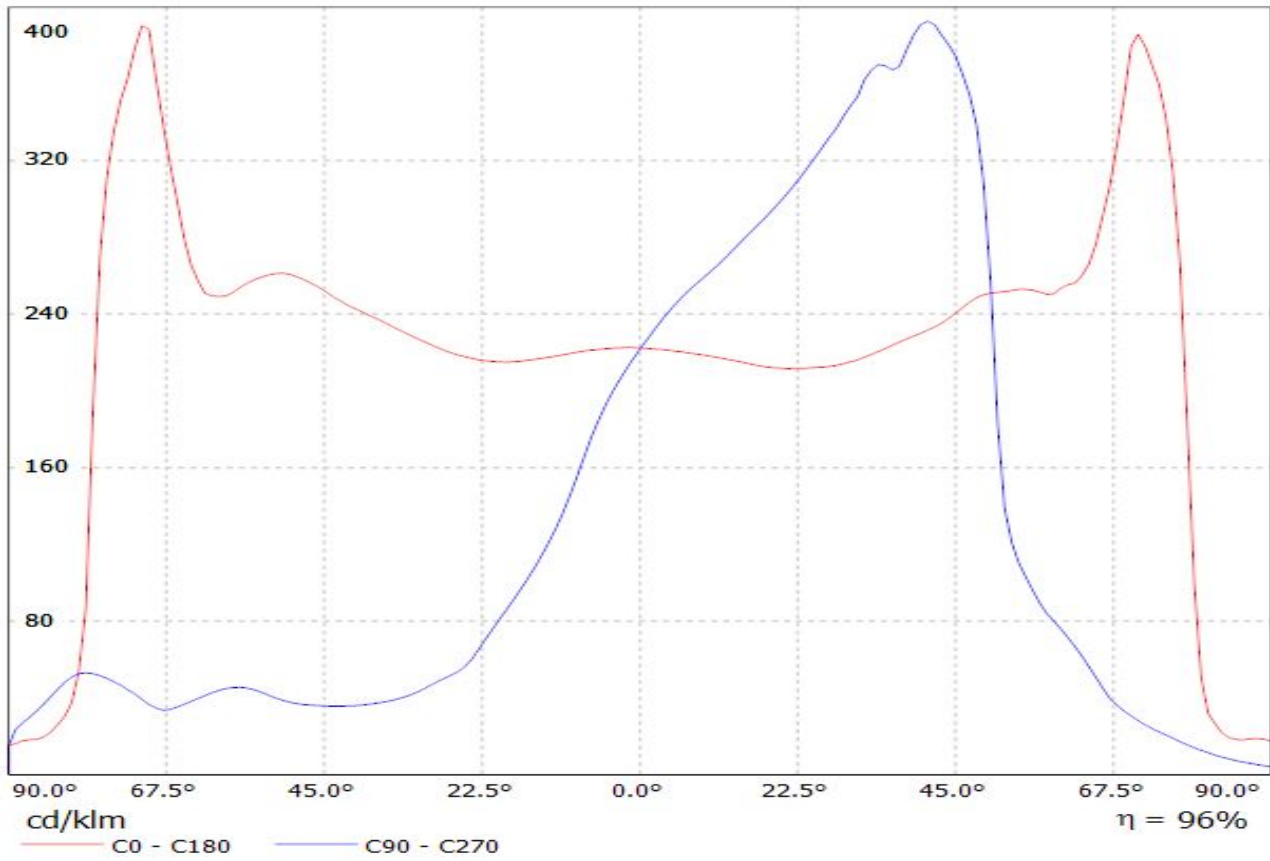

Luminaire: LEDiL Oy C13299_STRADA-2X2-ME_(LH351B)

Lamps: 1 x SAMSUNG_LH351B_2x2_442.45lm@250mA_P=2.84311W_I=249.9mA

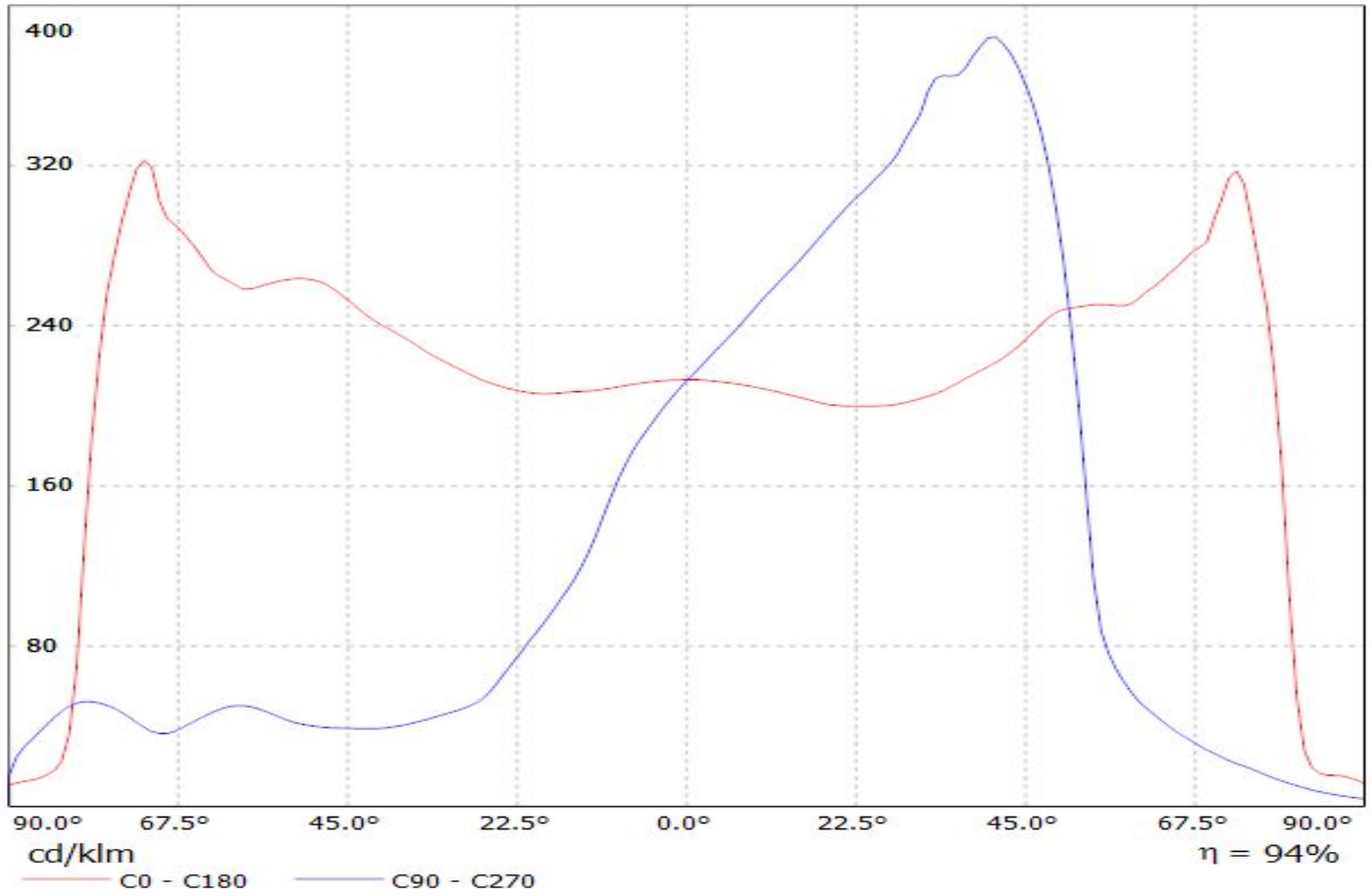

Ledil C13299_STRADA-2X2-ME_(TL1L3) / LDC (Linear)

Luminaire: Ledil C13299_STRADA-2X2-ME_(TL1L3)

Lamps: 1 x Toshiba_TL1L3_2x2_(TL1L3-NW1.L)_387.773lm@250mA_CCT=5000K_P=2.829W_I=0.25A

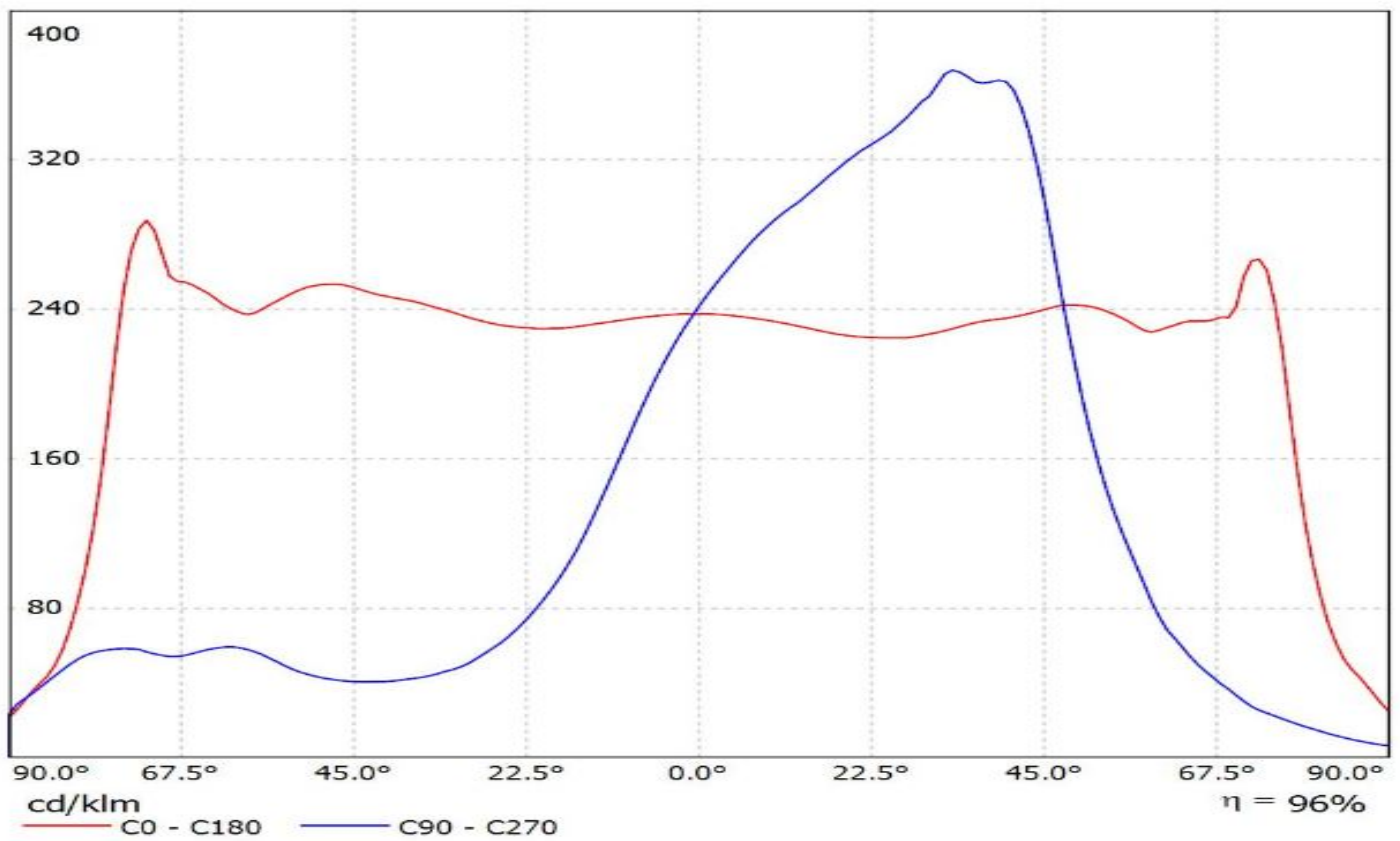

Luminaire: Ledil C13299_STRADA-2X2-ME_(Luxeon_TX)
Lamps: 1 x Luxeon_TX_2x2_(L1T2-3585)_331.643lm@250mA_P=3W_I=0.25A

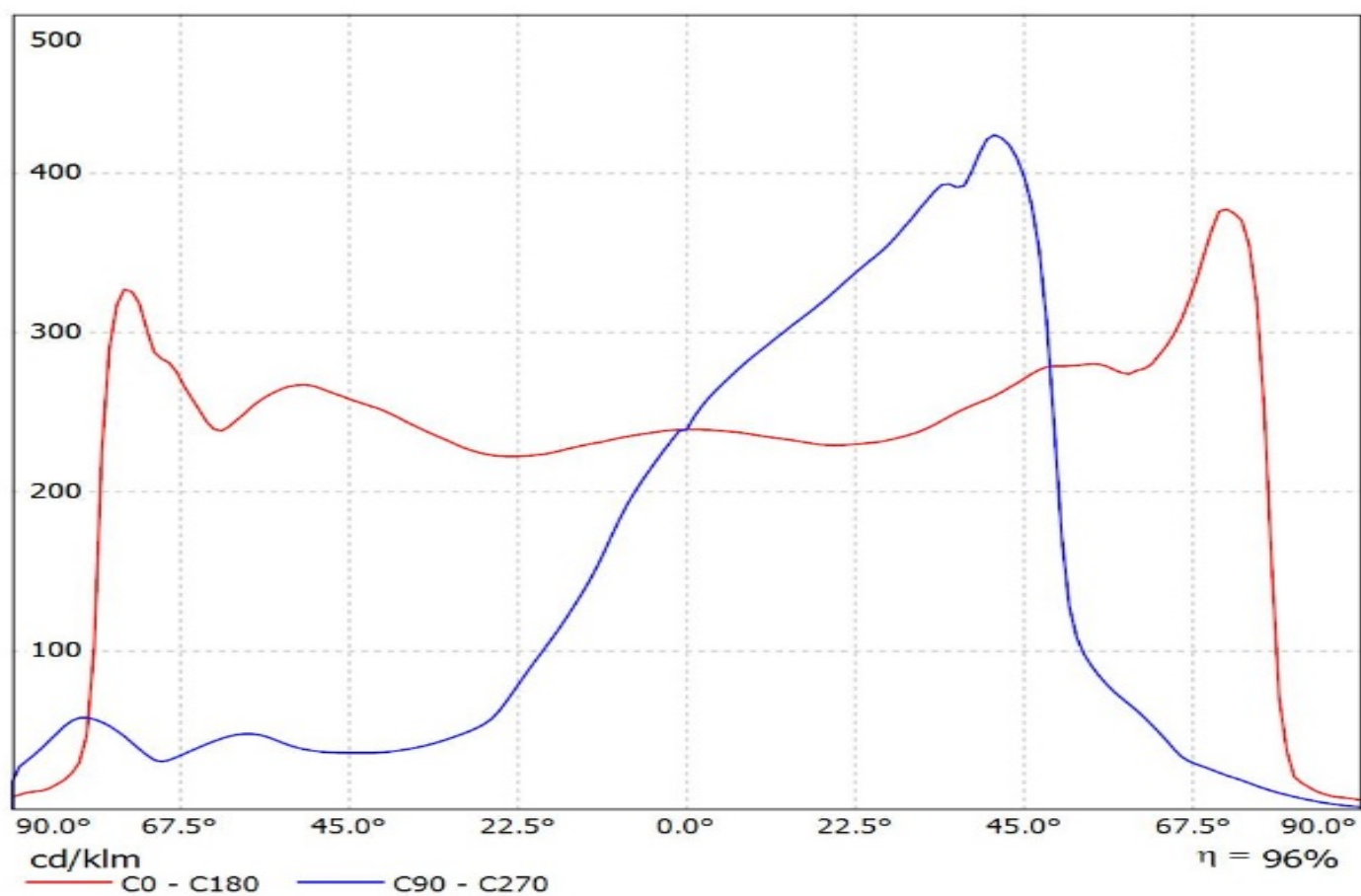

Luminaire: LEDiL Oy C13299_STRADA-2X2-ME_(Fortimo_F-Flex_2x8_740DAG3)
Lamps: 1 x Philips_Fortimo_F-Flex_2x8_740DAG3_1786.86lm@250mA_P=11.6092W_I=0.2498A

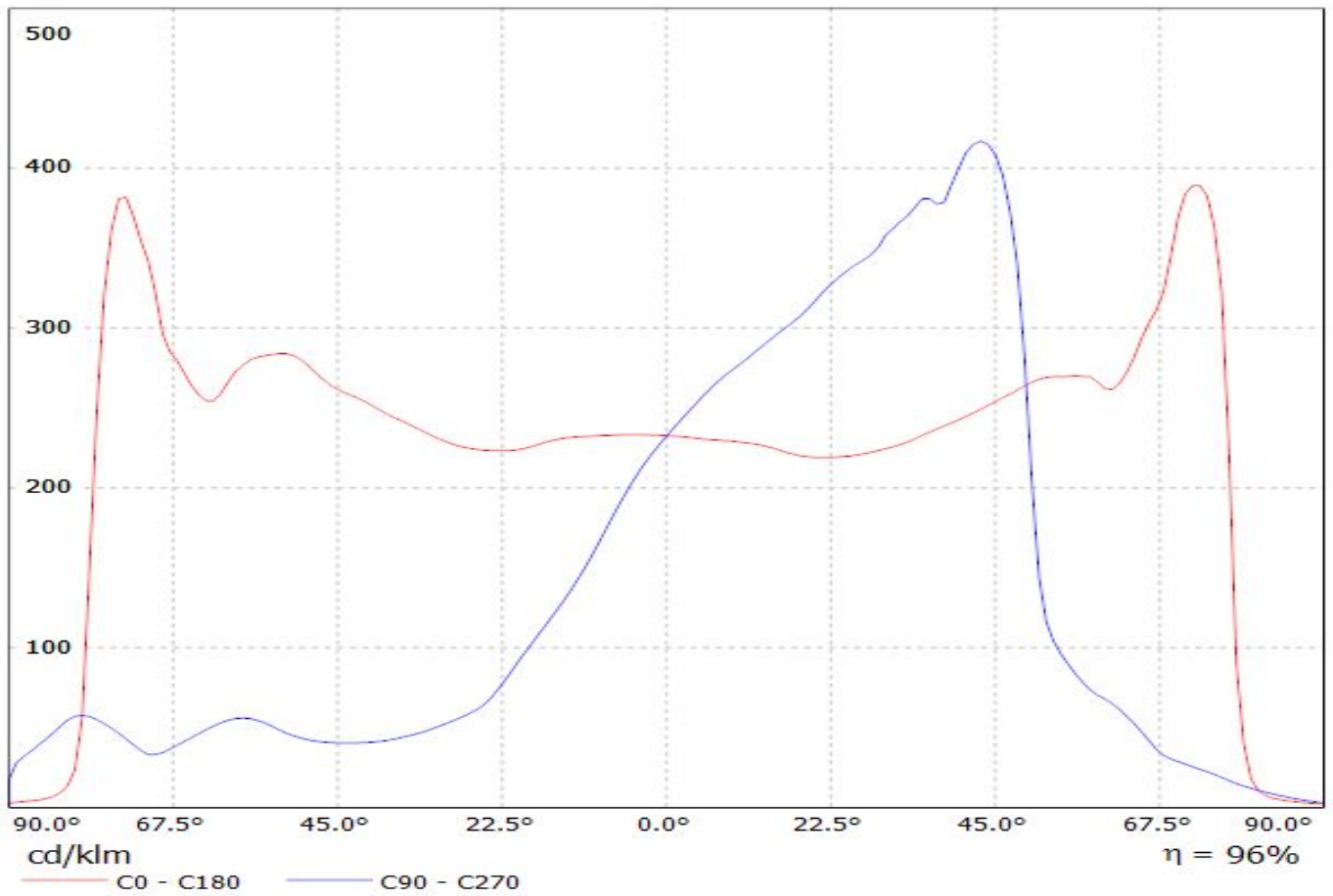

Ledil C13299_STRADA-2X2-ME_(TL1L4) / LDC (Linear)

Luminaire: Ledil C13299_STRADA-2X2-ME_(TL1L4)

Lamps: 1 x Toshiba_TL1L4_2x2_(TL1L4-DW0)_472.639lm@250mA_CCT=6500K_P=2.9W_I=0.25A

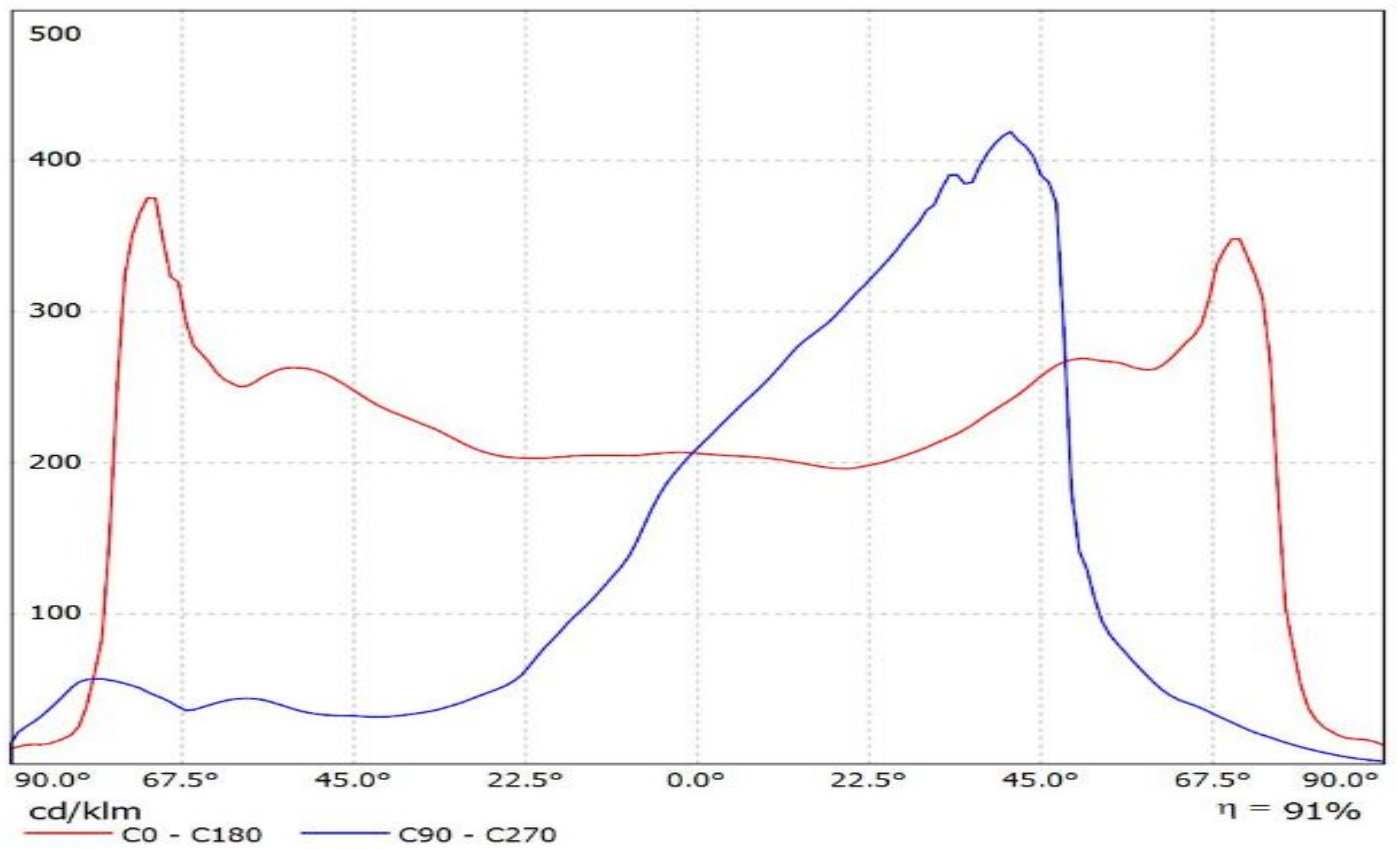

Luminaire: LEDiL Oy C13299_STRADA-2X2-ME_(XP-L_HI)
Lamps: 1 x Cree_XP-L_HI_(2x2)_(XPLAWT-H-5A3-U60-013-0001)
_455.077lm@250mA_P=2.84011W_I=0.2499A

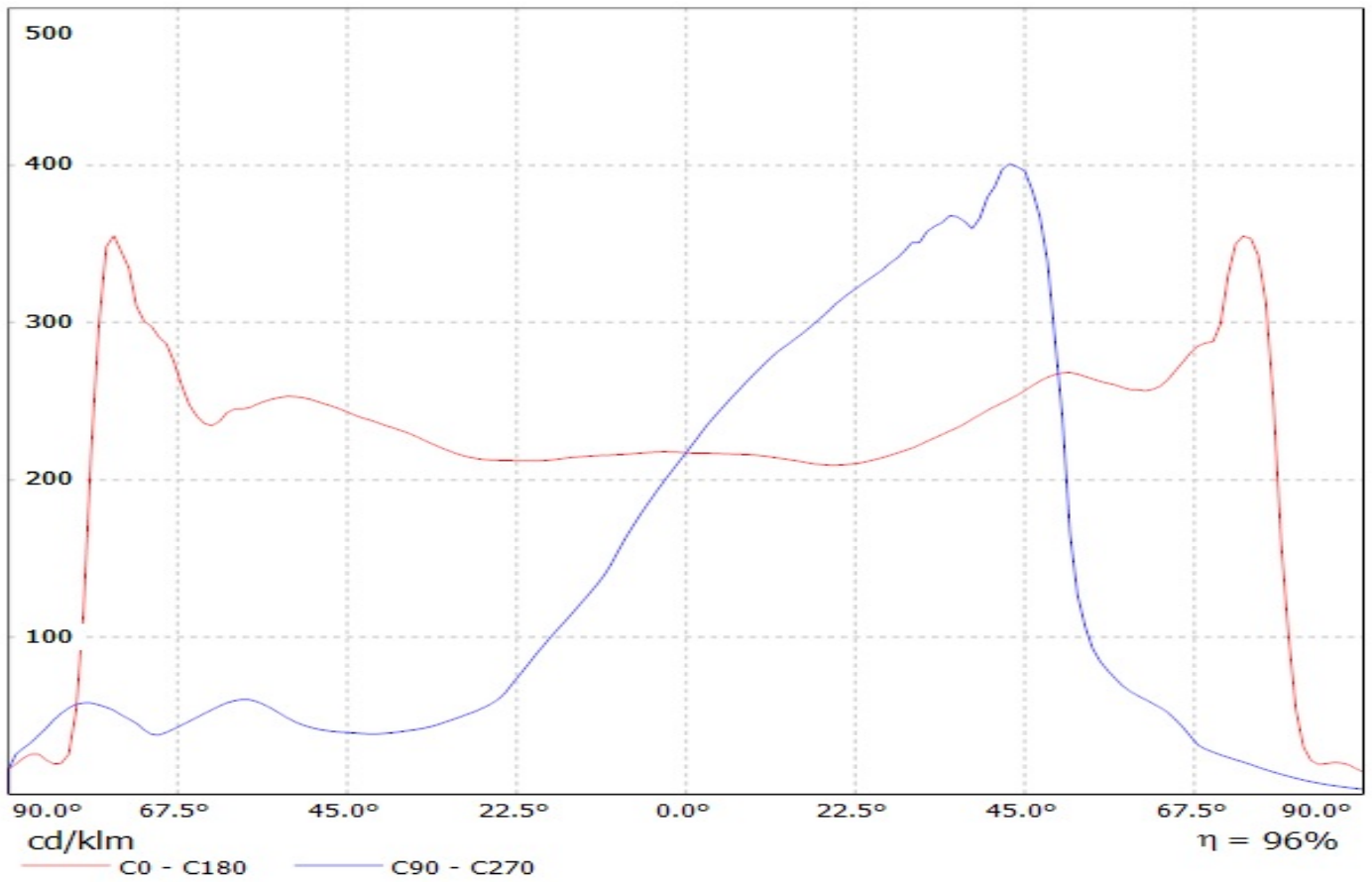

Luminaire: LEDiL Oy C13299_STRADA-2X2-ME_(Square_Gen3)

Lamps: 1 x Osram_Square_Gen3_GW_CSSRM2.PM_451.664lm@250mA_P=2.787_I=250mA

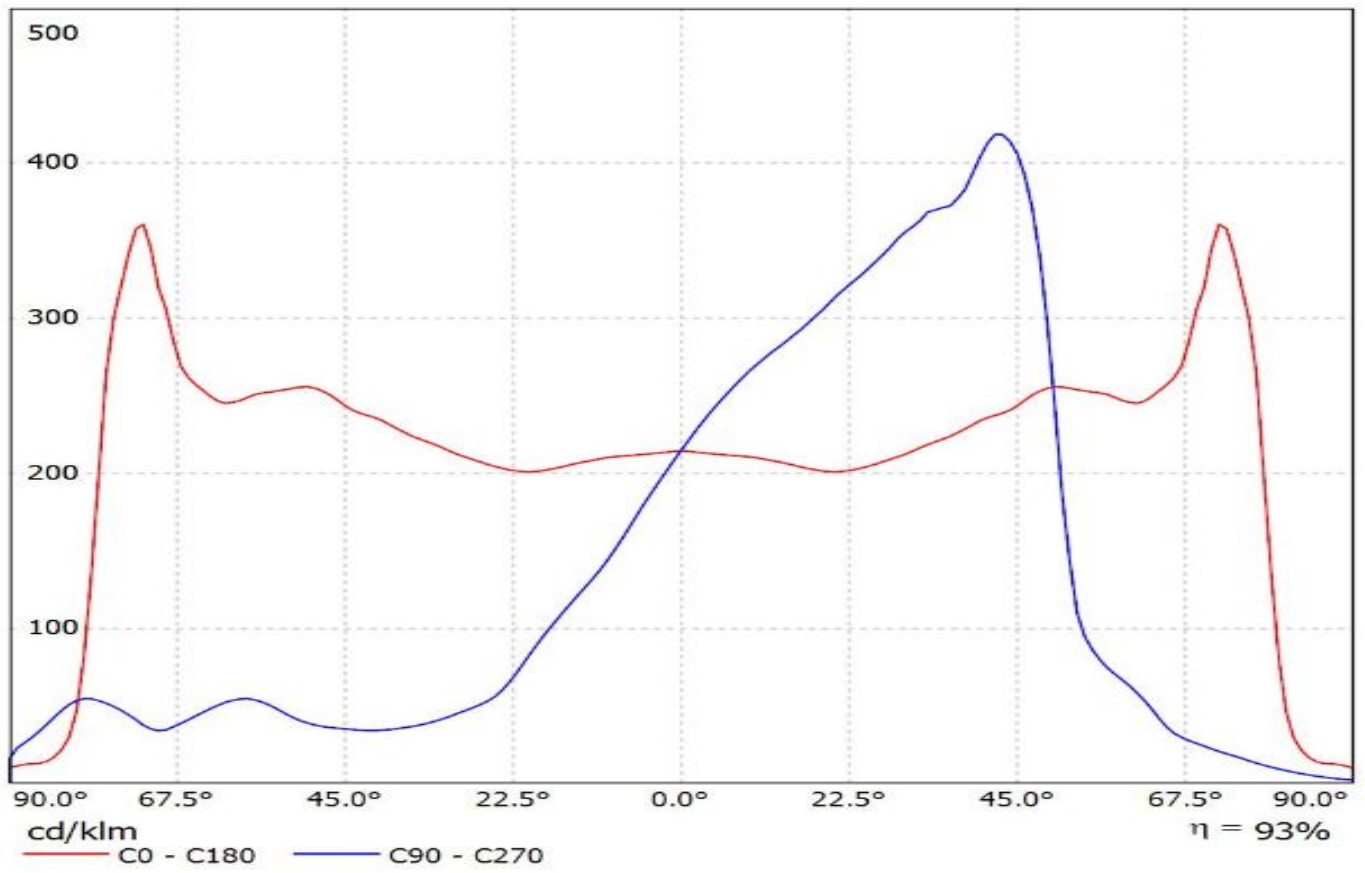

Luminaire: LEDiL Oy C13299_STRADA-2X2-ME_(XT-E)_3 Eff.94.0%
Lamps: 1 x CREE_XT-E_385.199lm@250mA_CCT=5717K

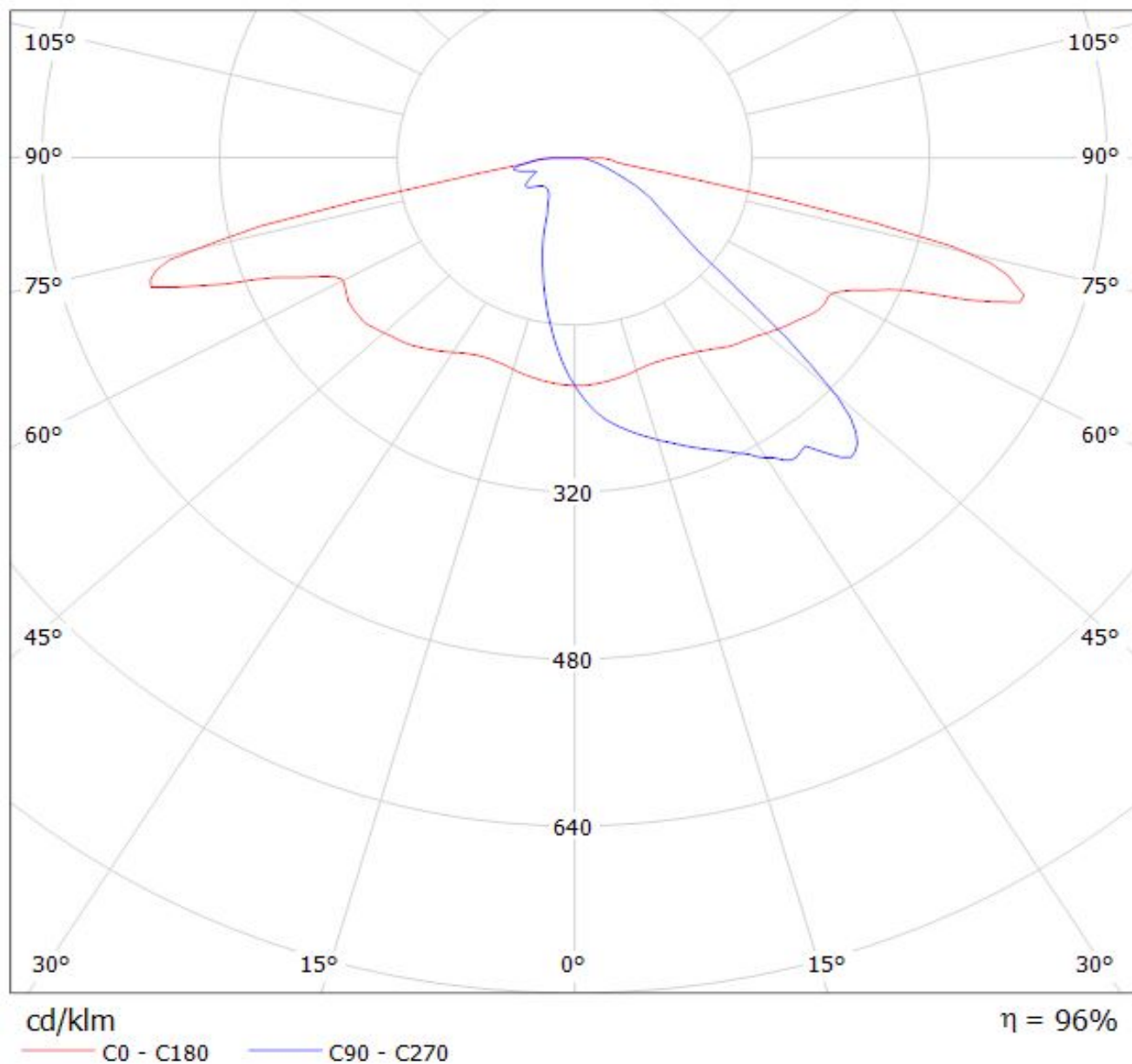

LEDiL Oy C13299_STRADA-2X2-ME_(XM-L) Eff.94.0% / LDC (Polar)

Luminaire: LEDiL Oy C13299_STRADA-2X2-ME_(XM-L) Eff.94.0%
Lamps: 1 x XM-L_2x2_360.4lm@250mA_P=2.82462W_I=249.9mA

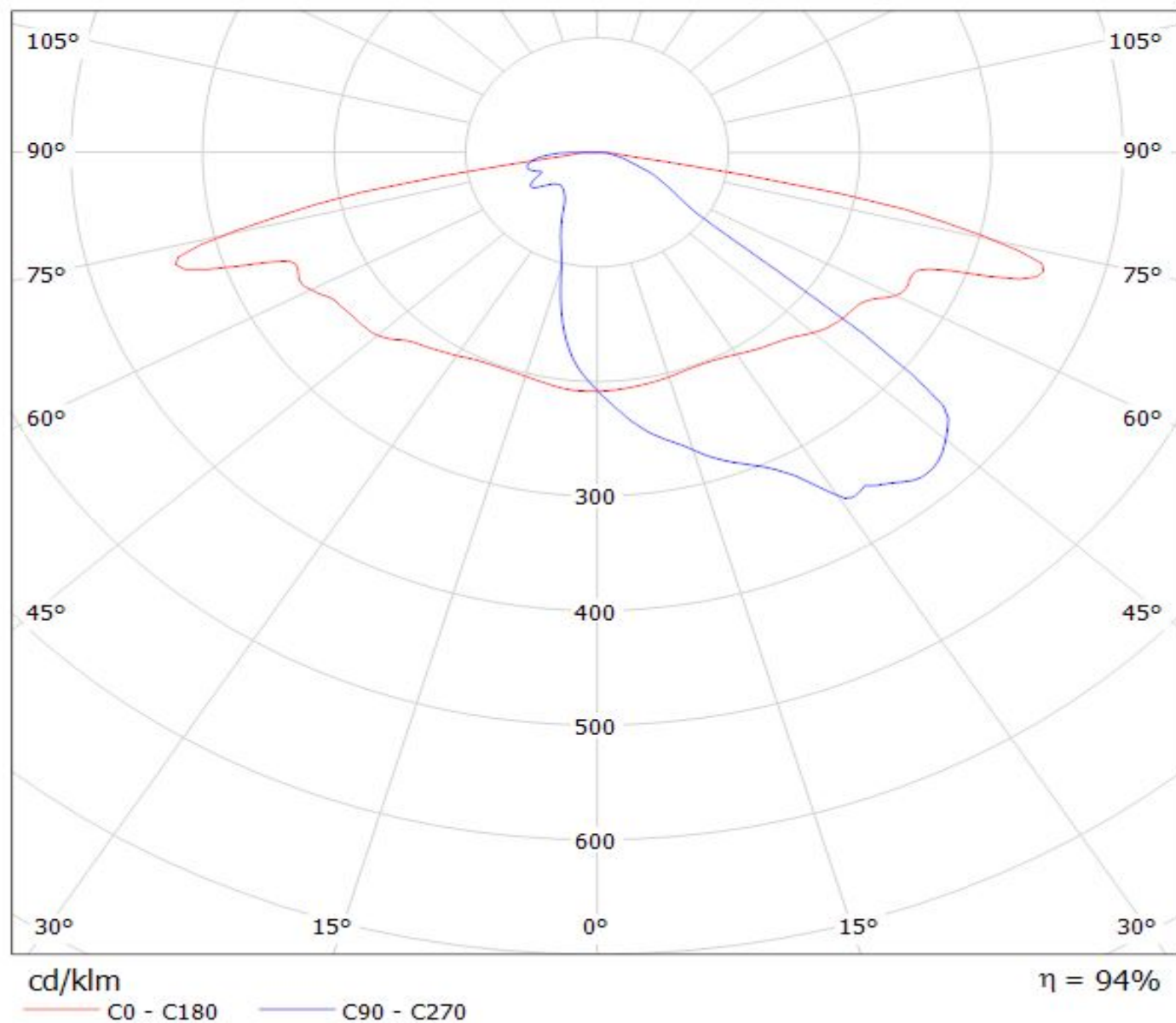

LEDiL Oy C13299_STRADA-2X2-ME_(N383) Eff.94.0% / LDC (Polar)

Luminaire: LEDiL Oy C13299_STRADA-2X2-ME_(N383) Eff.94.0%

Lamps: 1 x NICHIA_N383_2x2_(NS9W383T)_376.958lm@250mA_P=2.88194W_I=249.9mA

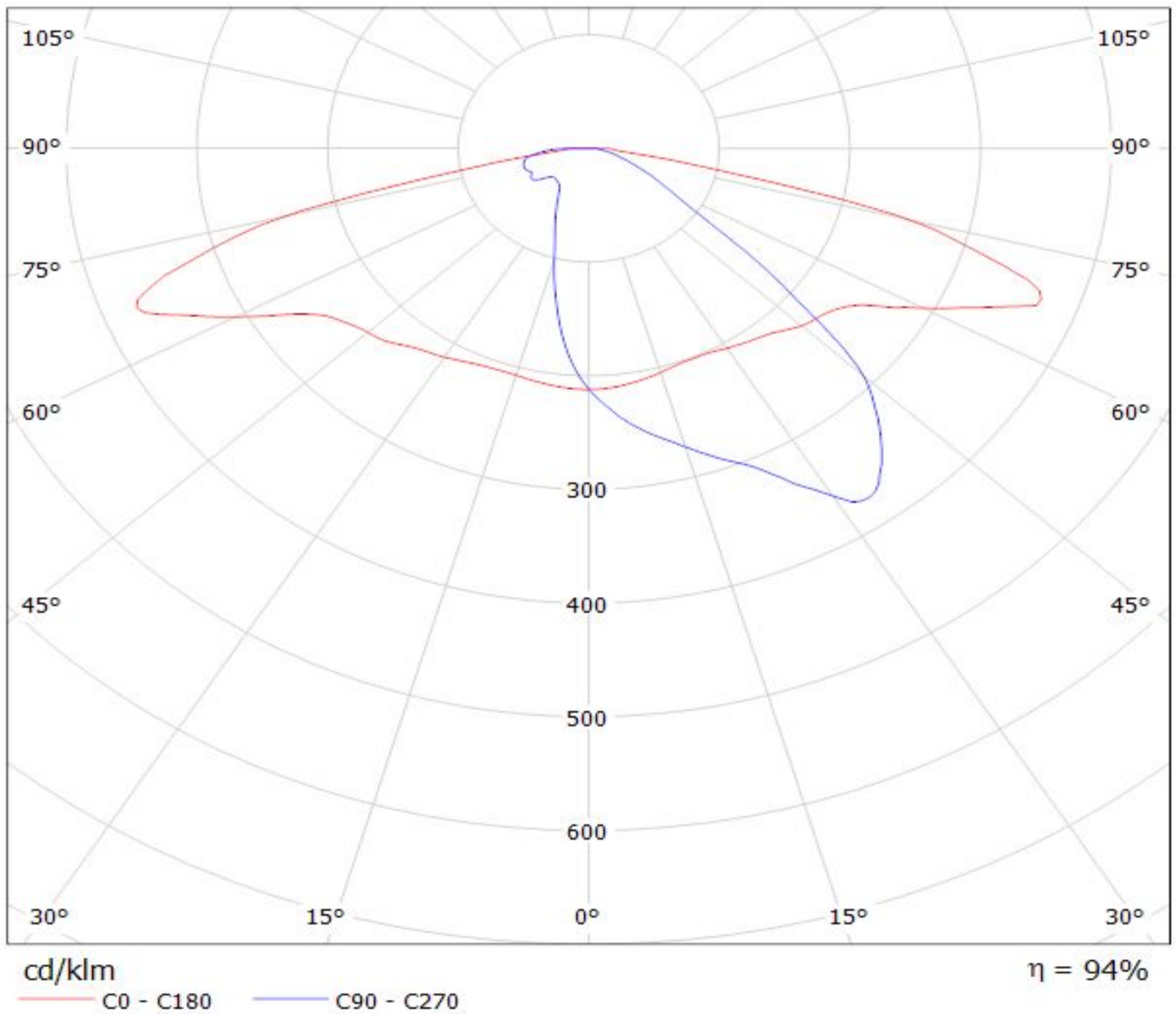

LEDiL Oy C13299_STRADA-2X2-ME_(XB-D) Eff.94.0% / LDC (Polar)

Luminaire: LEDiL Oy C13299_STRADA-2X2-ME_(XB-D) Eff.94.0%
Lamps: 1 x XB-D_2x2_368.85lm@250mA_P=3.06227W_I=249.9mA

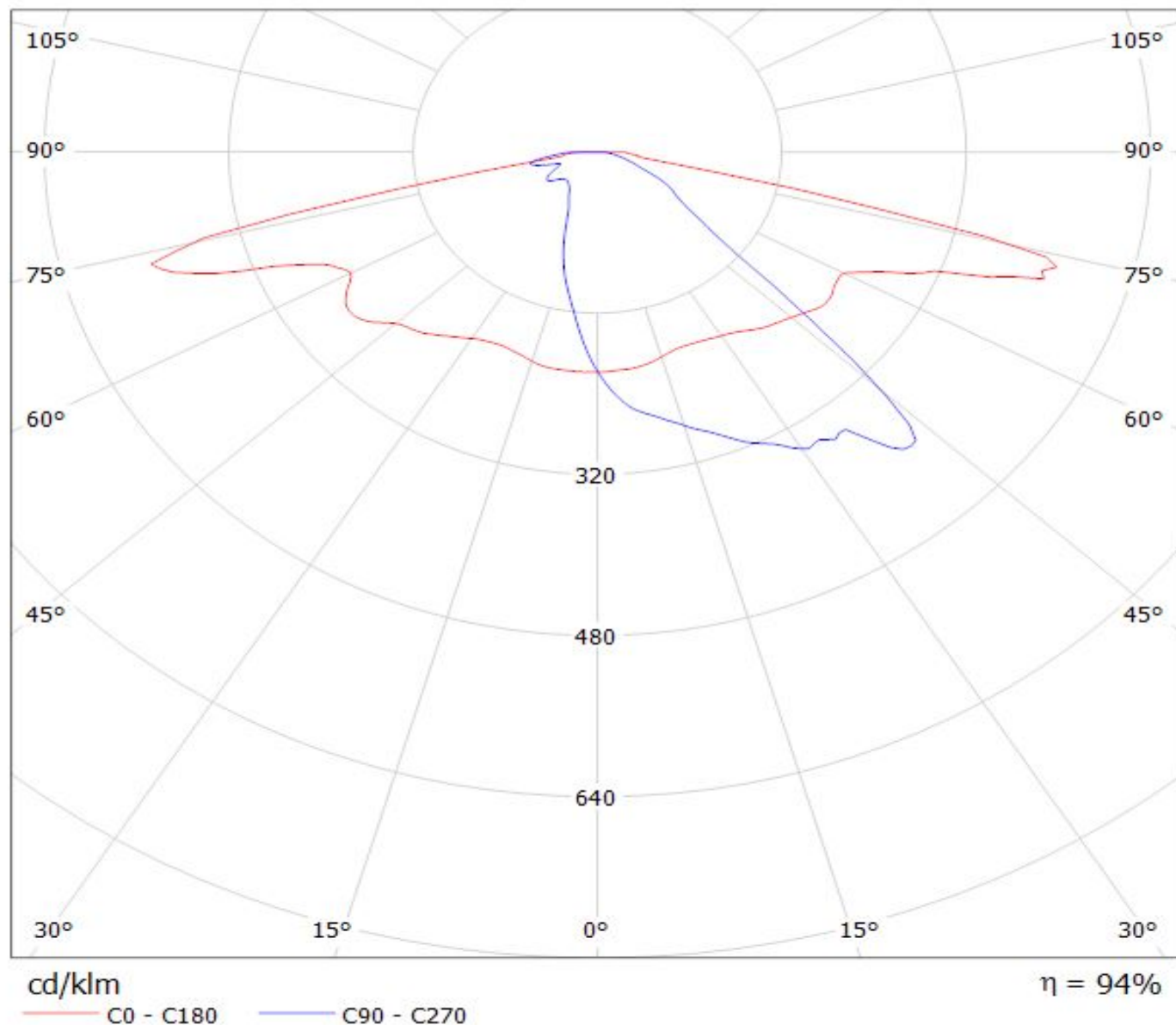

LEDiL Oy C13299_STRADA-2X2-ME_(XP-G2) Eff.94.0% / LDC (Polar)

Luminaire: LEDiL Oy C13299_STRADA-2X2-ME_(XP-G2) Eff.94.0%

Lamps: 1 x XP-G2_2x2_(XPGBWT-L1-000-00G51)

_418.9lm@250mA_CCT=7181K_P=2.93358W_I=249.9mA

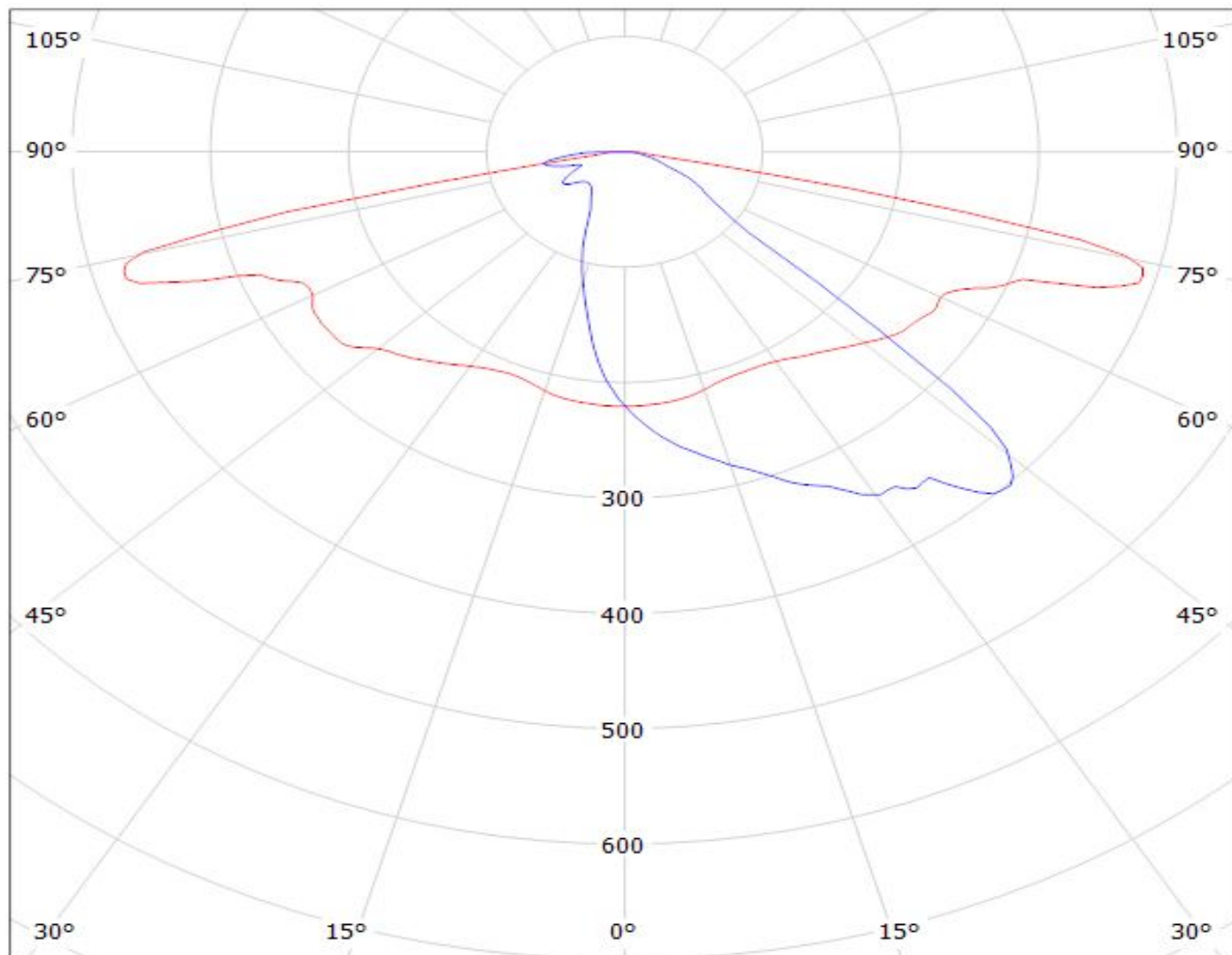

cd/klm

— C0 - C180

— C90 - C270

$\eta = 94\%$

LEDiL Oy C13299_STRADA-2X2-ME_(XP-G) / LDC (Polar)

Luminaire: LEDiL Oy C13299_STRADA-2X2-ME_(XP-G)

Lamps: 1 x XP-G_2x2_258.35lm@250mA_P=2.88734W_I=249.9mA

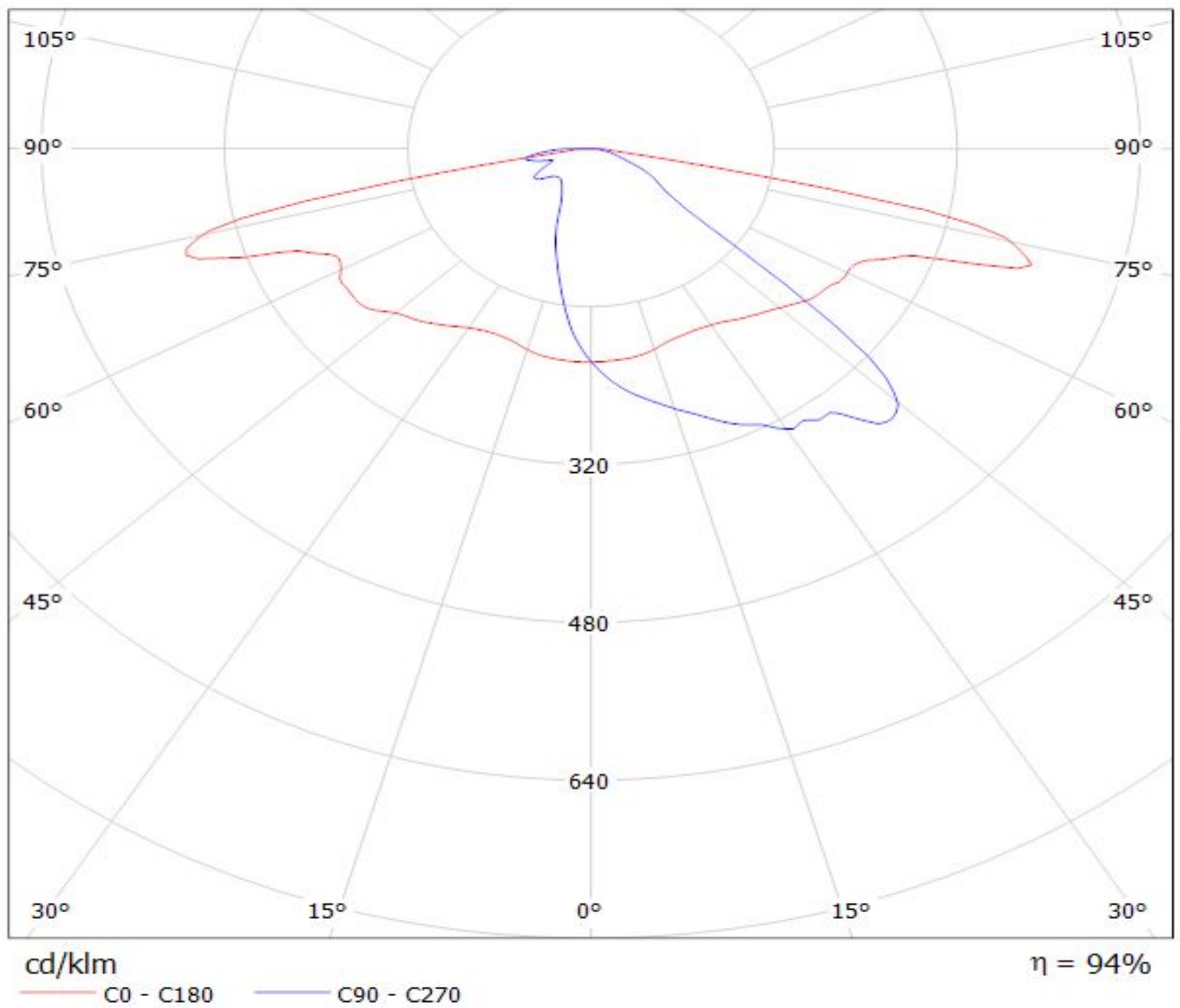

LEDiL Oy C13299_STRADA-2X2-ME_(SQ-PC) Eff.94.0% / LDC (Polar)

Luminaire: LEDiL Oy C13299_STRADA-2X2-ME_(SQ-PC) Eff.94.0%

Lamps: 1 x SQ-PC_2x2_(LCW-CQAR.PC-MSMU-5H71-1)_400.75lm@250mA_CCT=?

K_P=2.96681W_I=249.9mA

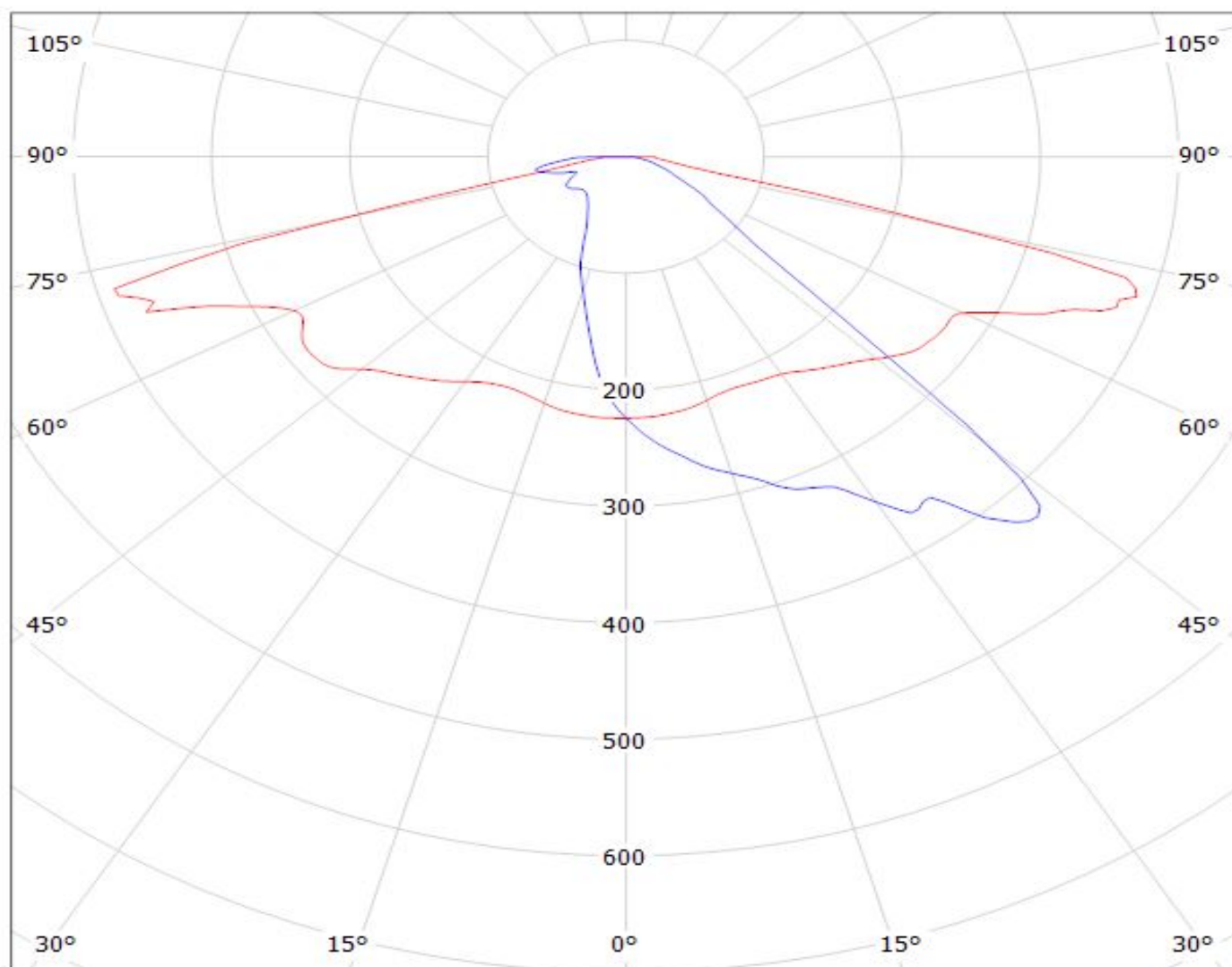

cd/klm

— C0 - C180

— C90 - C270

$\eta = 94\%$

LEDiL Oy C13299_STRADA-2X2-ME_(Luxeon-R) Eff.94.0% / LDC (Polar)

Luminaire: LEDiL Oy C13299_STRADA-2X2-ME_(Luxeon-R) Eff.94.0%

Lamps: 1 x Luxeon_R_2x2_(LXA7-PW30)_314.75lm@250mA_P=2.77914W_I=249.9mA

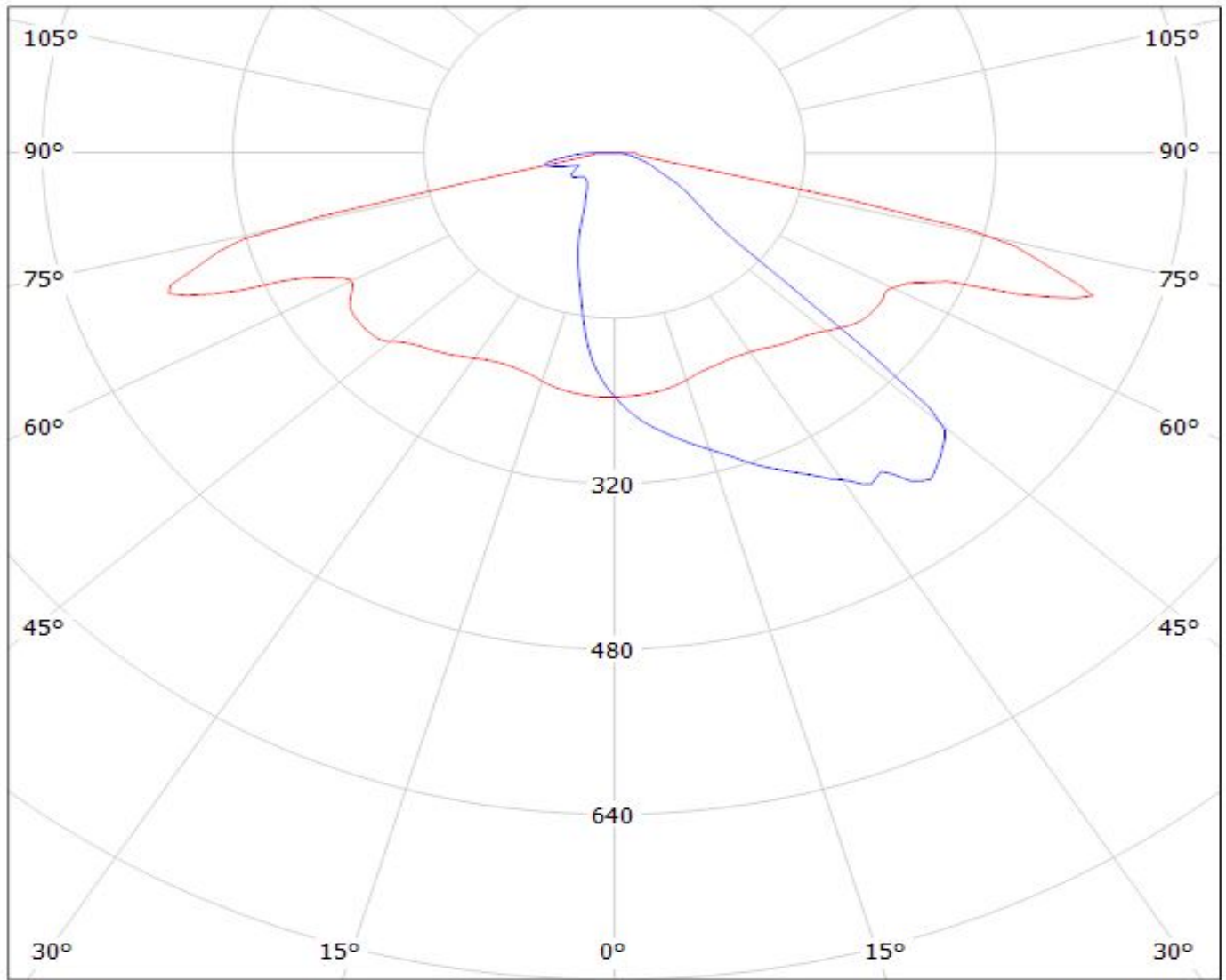

cd/klm

— C0 - C180

— C90 - C270

$\eta = 94\%$

LEDiL Oy C13299_STRADA-2X2-ME_(Rebel-ES) Eff.94.0% / LDC (Polar)

Luminaire: LEDiL Oy C13299_STRADA-2X2-ME_(Rebel-ES) Eff.94.0%

Lamps: 1 x Luxeon_Rebel-ES_2x2_341.5lm@250mA_P=2.86485W_I=249.9mA

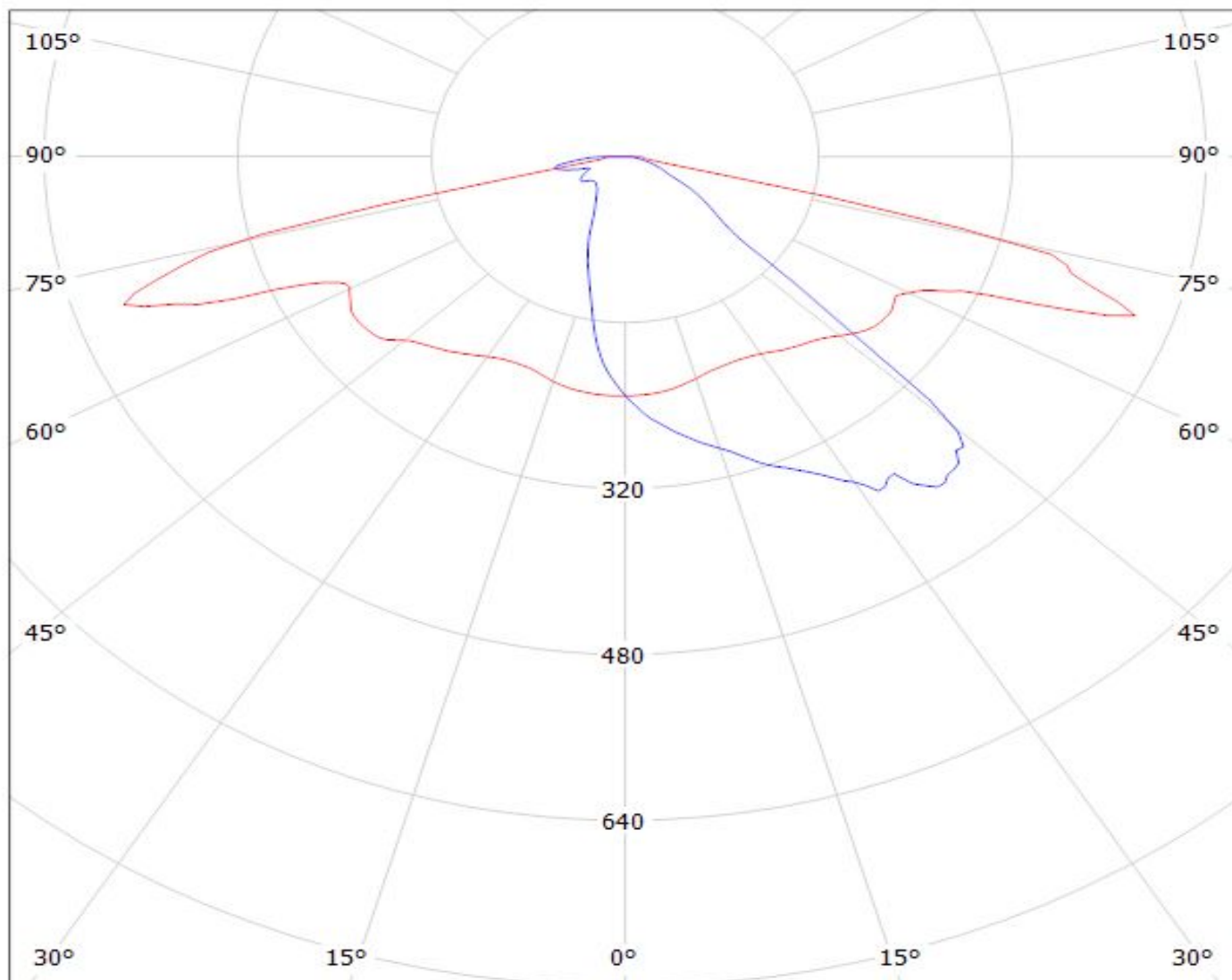

cd/klm

— C0 - C180 — C90 - C270

$\eta = 94\%$

Luminaire: LEDiL Oy C13299_STRADA-2x2-ME_(Luxeon_T)
Lamps: 1 x Luxeon T (LXH8-FW30-3) 303lm@250mA P=2.80138W I=0.2499A

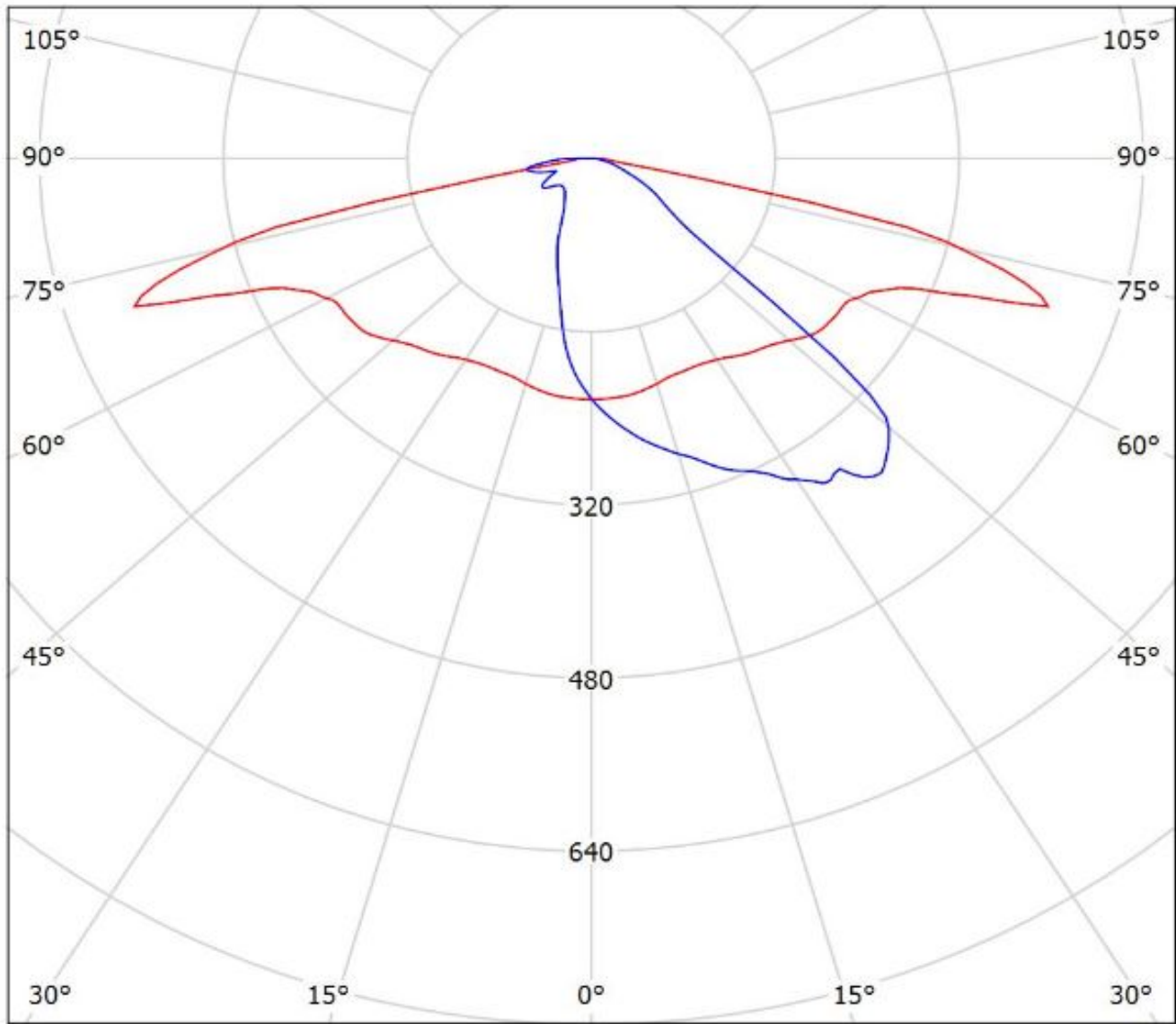

cd/klm
— C0 - C180 — C90 - C270

$\eta = 94\%$

LEDiL Oy C13299_STRADA-2X2-ME_(Z5P) Eff.94.0% / LDC (Polar)

Luminaire: LEDiL Oy C13299_STRADA-2X2-ME_(Z5P) Eff.94.0%

Lamps: 1 x Seoul_Z5P_2x2_290.05lm@250mA_P=3.6208W_I=249.9mA

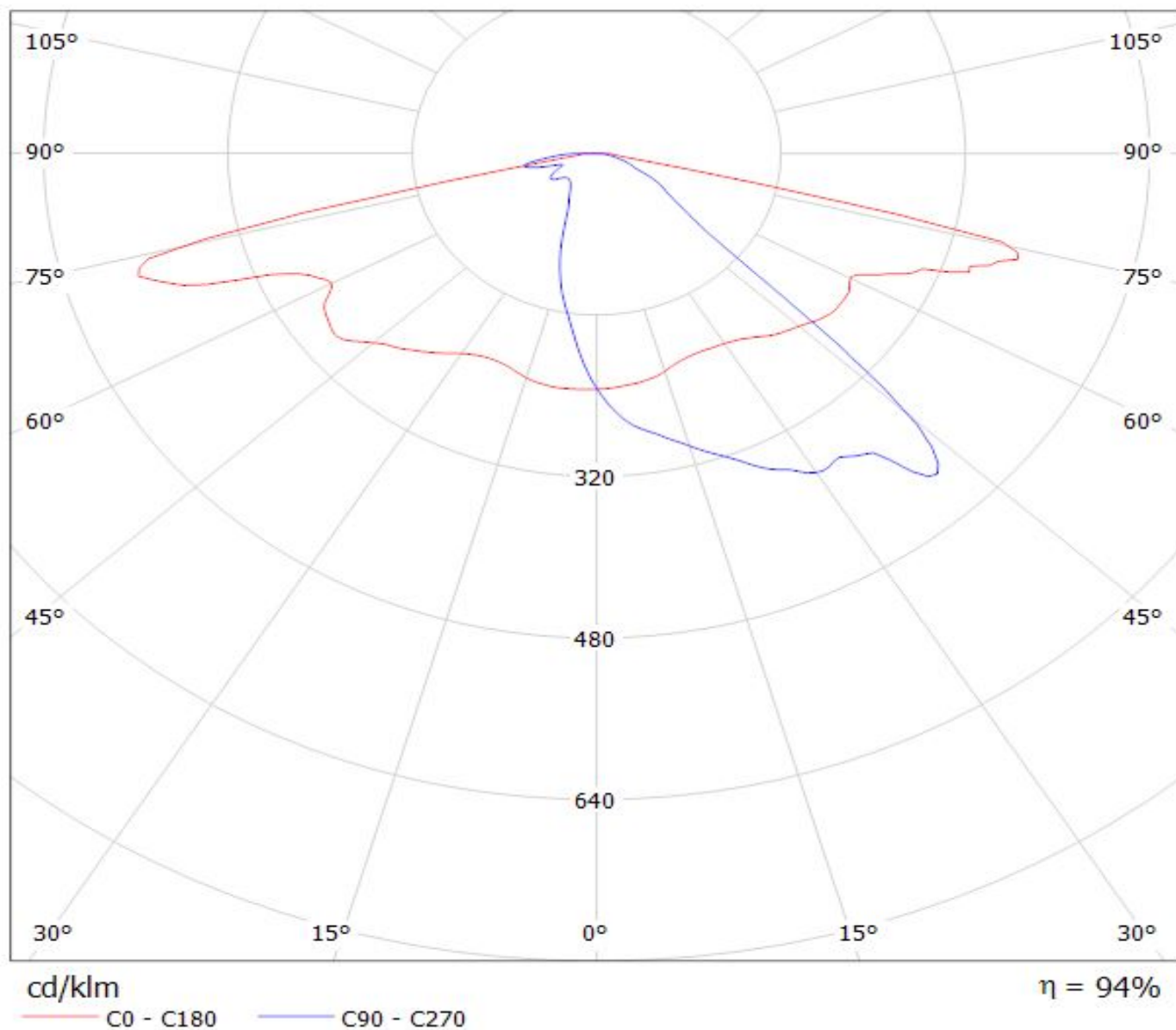

Luminaire: LEDiL Oy C13299_STRADA-2x2-ME_(MJT4040) Eff. 94%

Lamps: 1 x SEOUL ACHRICH MJT4040 (SAW09H0A) 255lm@40mA P=2.37W I=40mA

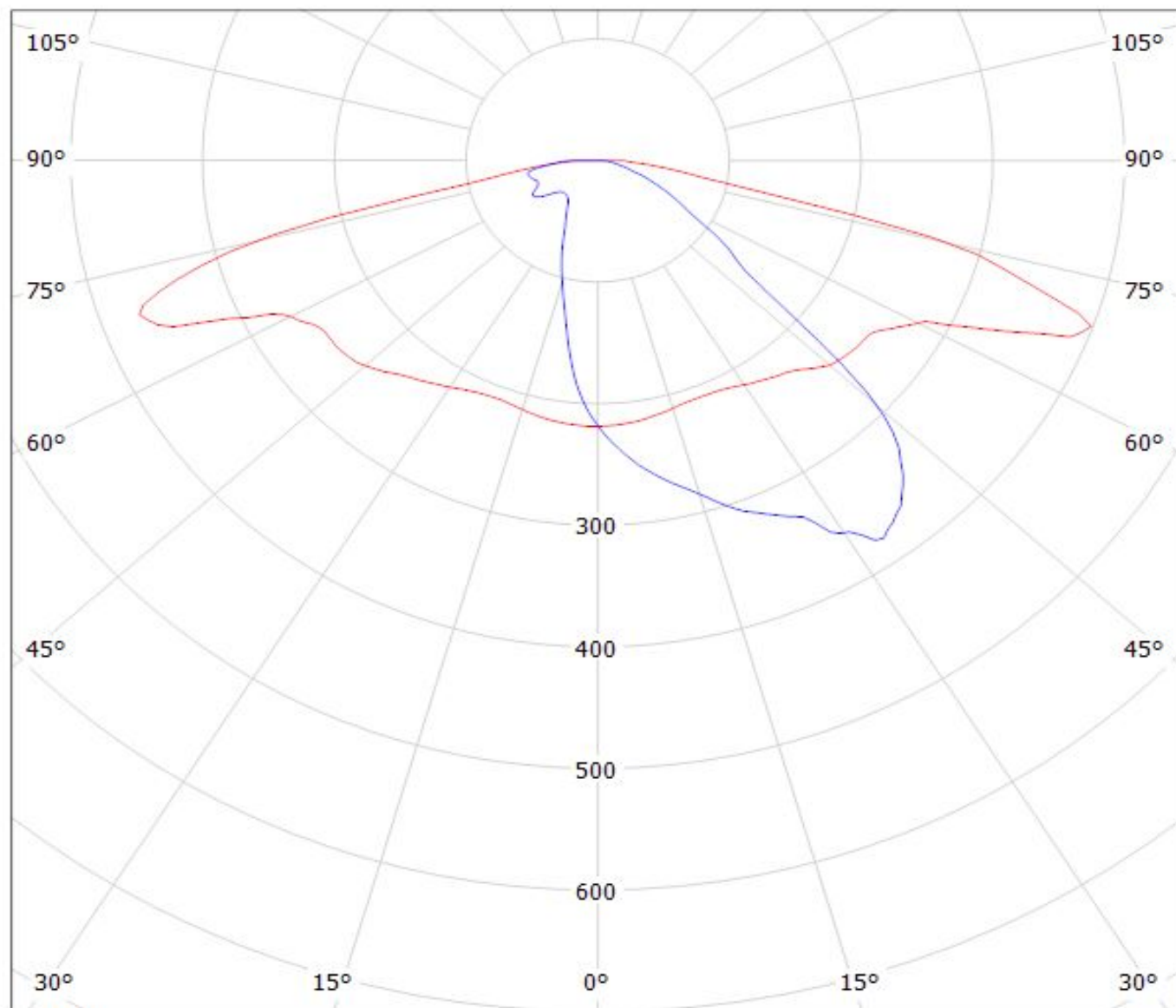

cd/klm

— C0 - C180

— C90 - C270

$\eta = 95\%$

**LEDiL Oy C13299_STRADA-2X2-ME_(LG-3535-CERAMIC-GEN2) Eff.94.0% /
LDC (Polar)**

Luminaire: LEDiL Oy C13299_STRADA-2X2-ME_(LG-3535-CERAMIC-GEN2) Eff.94.0%
Lamps: 1 x LG-3535-CERAMIC-GEN2_2x2_475.9lm@250mA_P=2.8651W_CCT=6562K_I=249.9mA

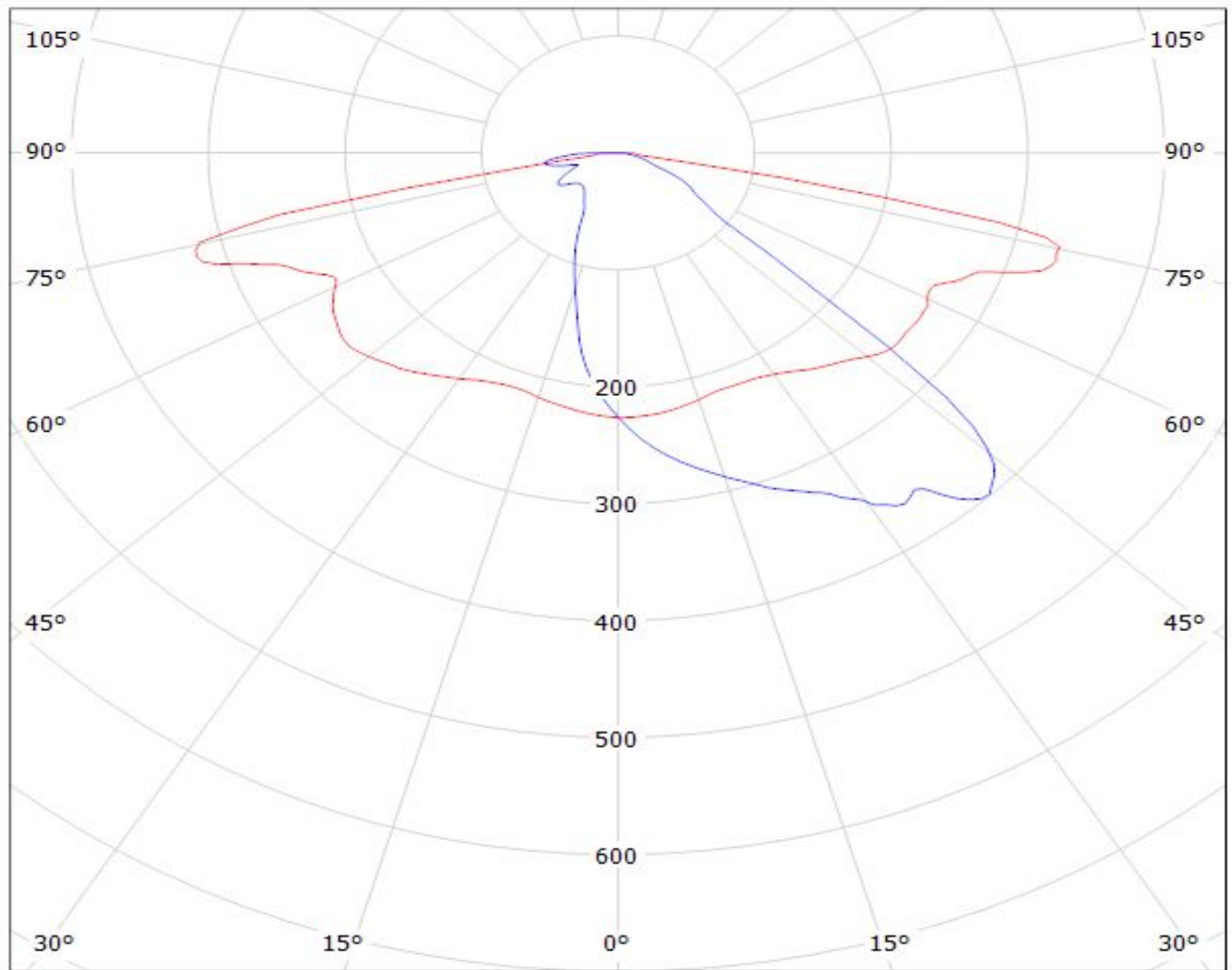

cd/klm

— C0 - C180 — C90 - C270

$\eta = 94\%$

Luminaire: LEDiL Oy C13299_STRADA-2x2-ME_(Luxeon_Z_ES) Eff. 94%
Lamps: 1 x Luxeon_Z_ES_2x2_(LXZ2-3090)_210.126lm@250mA_P=2.81862W_I=249.9mA

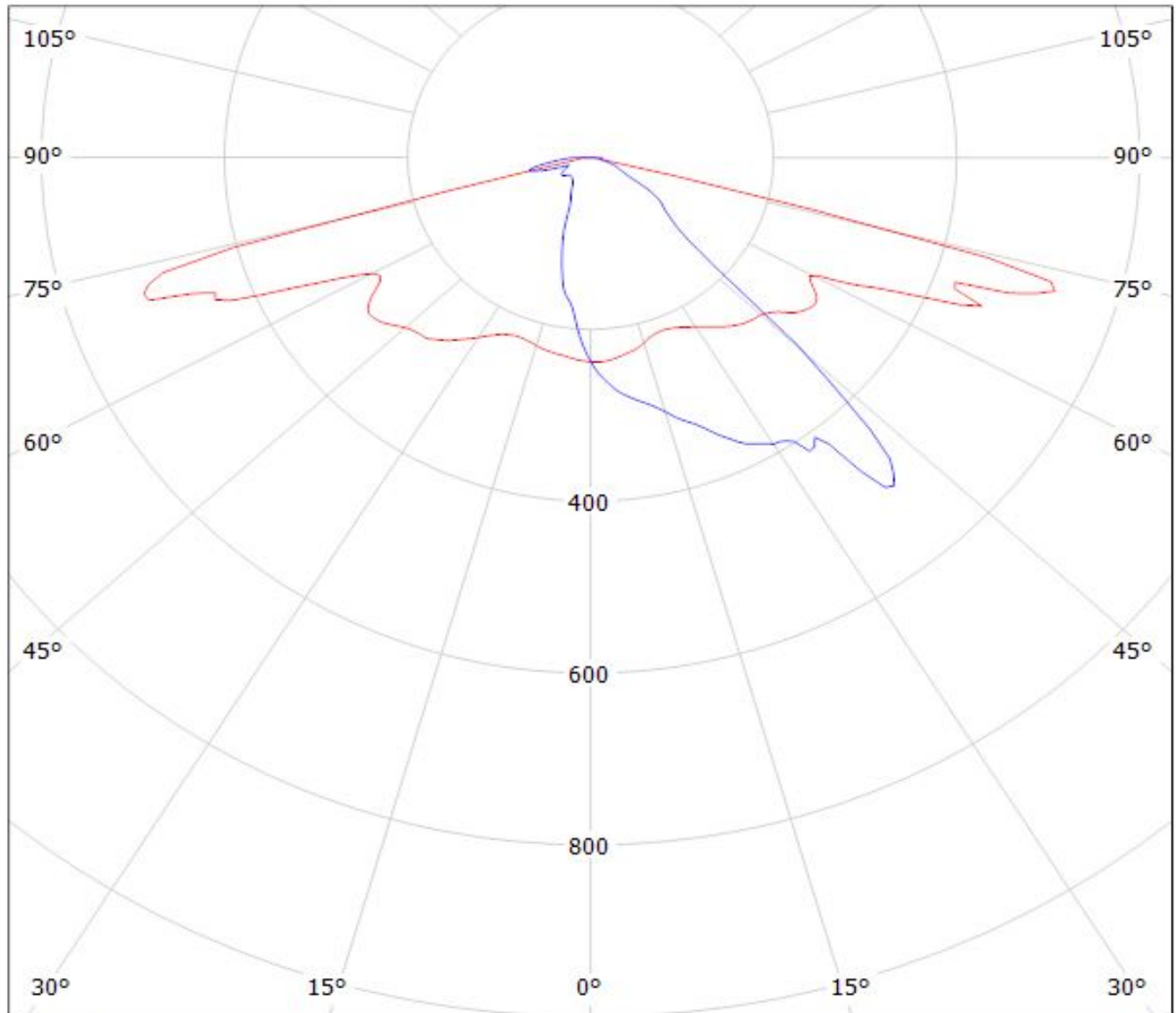

cd/klm

— C0 - C180 — C90 - C270

$\eta = 96\%$

LEDiL Oy C13299_STRADA-2X2-ME_(XP-E2) Eff.94.0% / LDC (Polar)

Luminaire: LEDiL Oy C13299_STRADA-2X2-ME_(XP-E2) Eff.94.0%

Lamps: 1 x CREE_XP-E2_2x2_(XPEBWT-L1-7B4-Q4-0-01)

_341.05lm@250mA_P=2.92366W_I=249.8mA

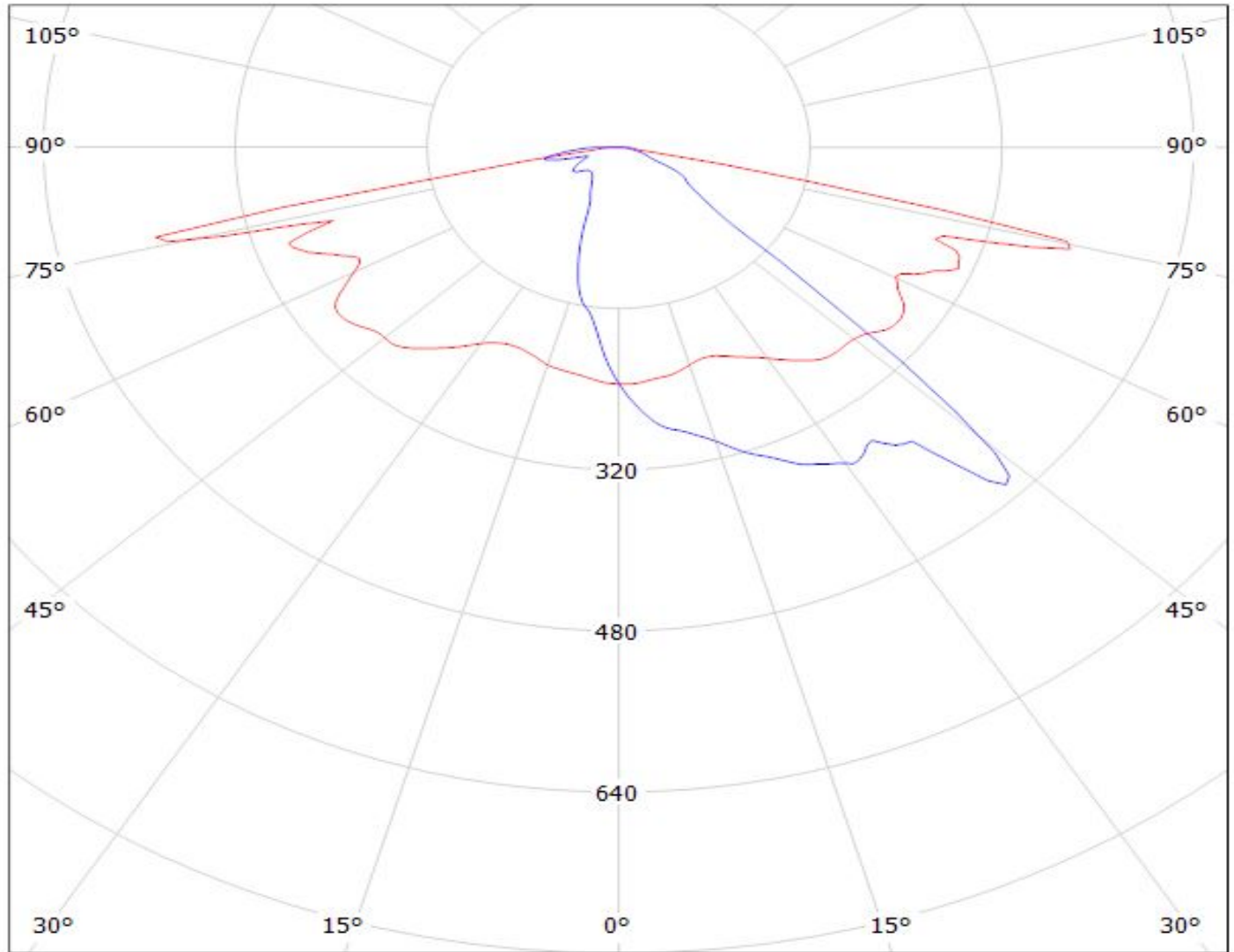

cd/klm

— C0 - C180

— C90 - C270

$\eta = 94\%$

LEDiL Oy C13299_STRADA-2X2-ME_(Z5M) Eff.94.0% / LDC (Polar)

Luminaire: LEDiL Oy C13299_STRADA-2X2-ME_(Z5M) Eff.94.0%

Lamps: 1 x SEOUL_Z5M_(SZ5-M0-W0-00)_364.5lm@250mA_P=2.95788W_I=249.8mA

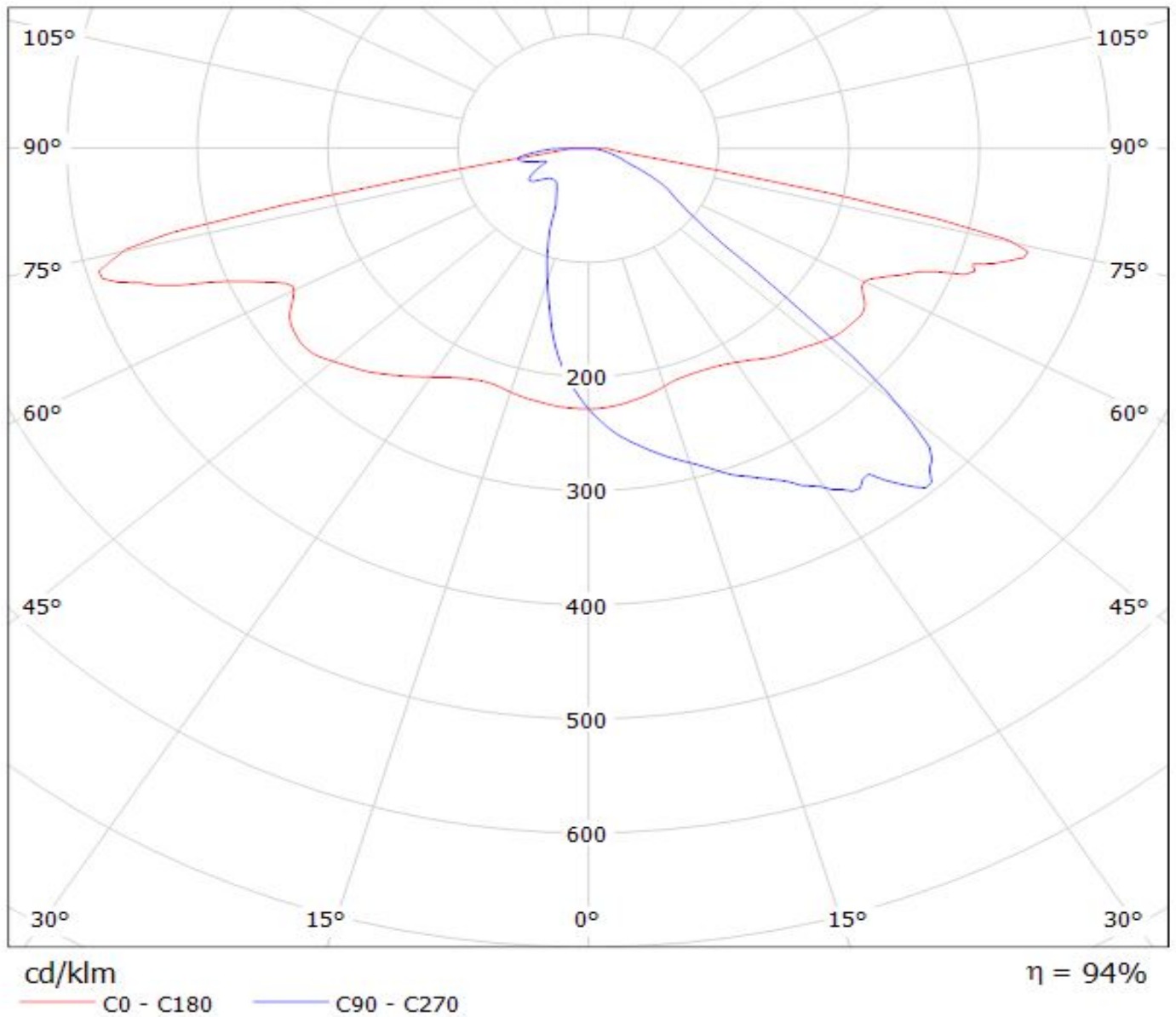

Luminaire: LEDiL Oy C13299_STRADA-2X2-ME_(LUXEON_Q)

Lamps: 1 x LUXEON_Q_2x2_(LHQ-3080)_298.615lm@250mA_P=2.86995W_I=249.8mA

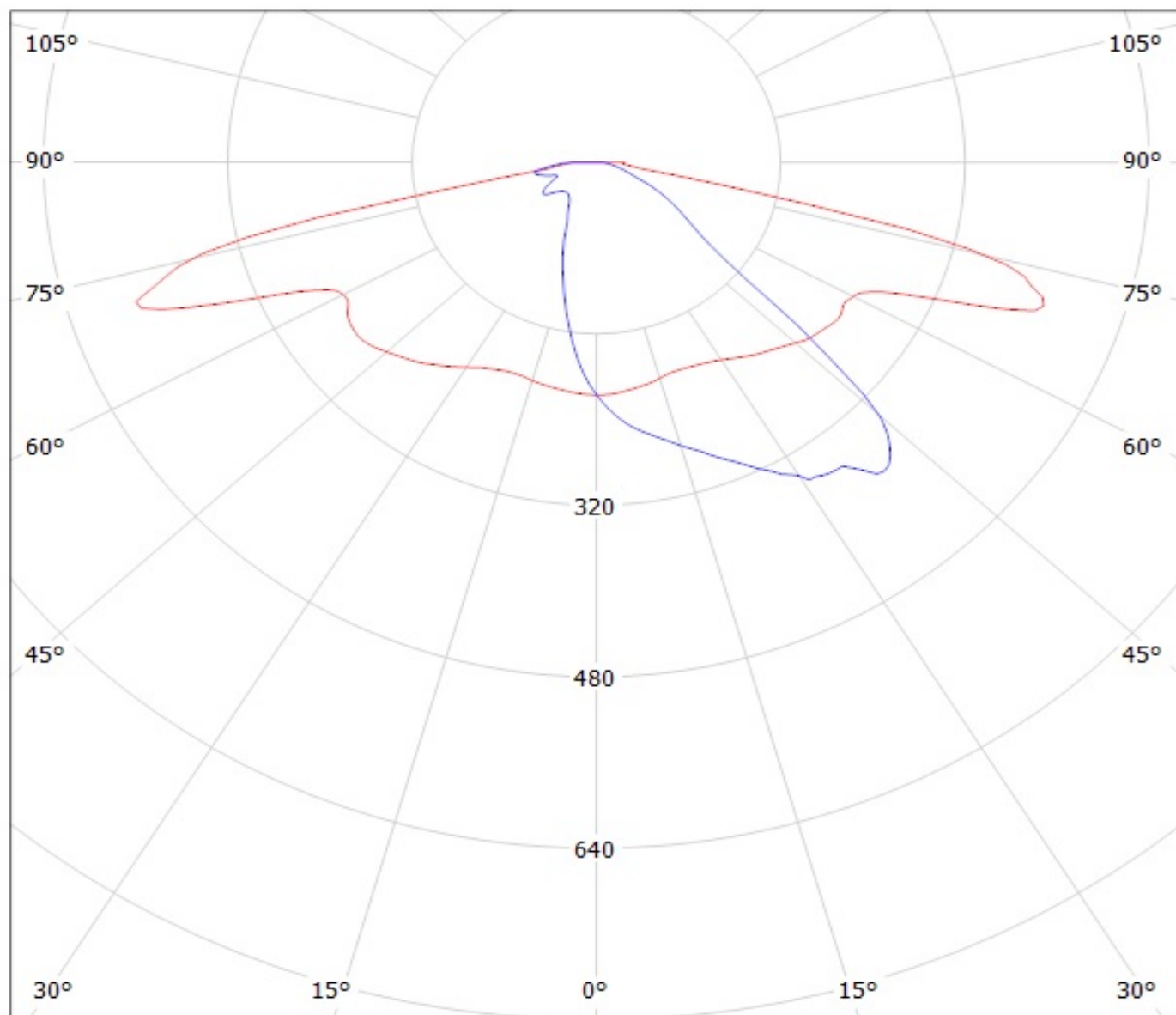

cd/klm

— C0 - C180

— C90 - C270

Luminaire: LEDil Oy C13299_STRADA-2X2-ME_(Z5M1) Efficiency=94%
Lamps: 1 x Seoul Z5M1 (SZ5-M1-WN-C8) 379lm @ 250mA CCT=4600K P=2.9W I=250mA

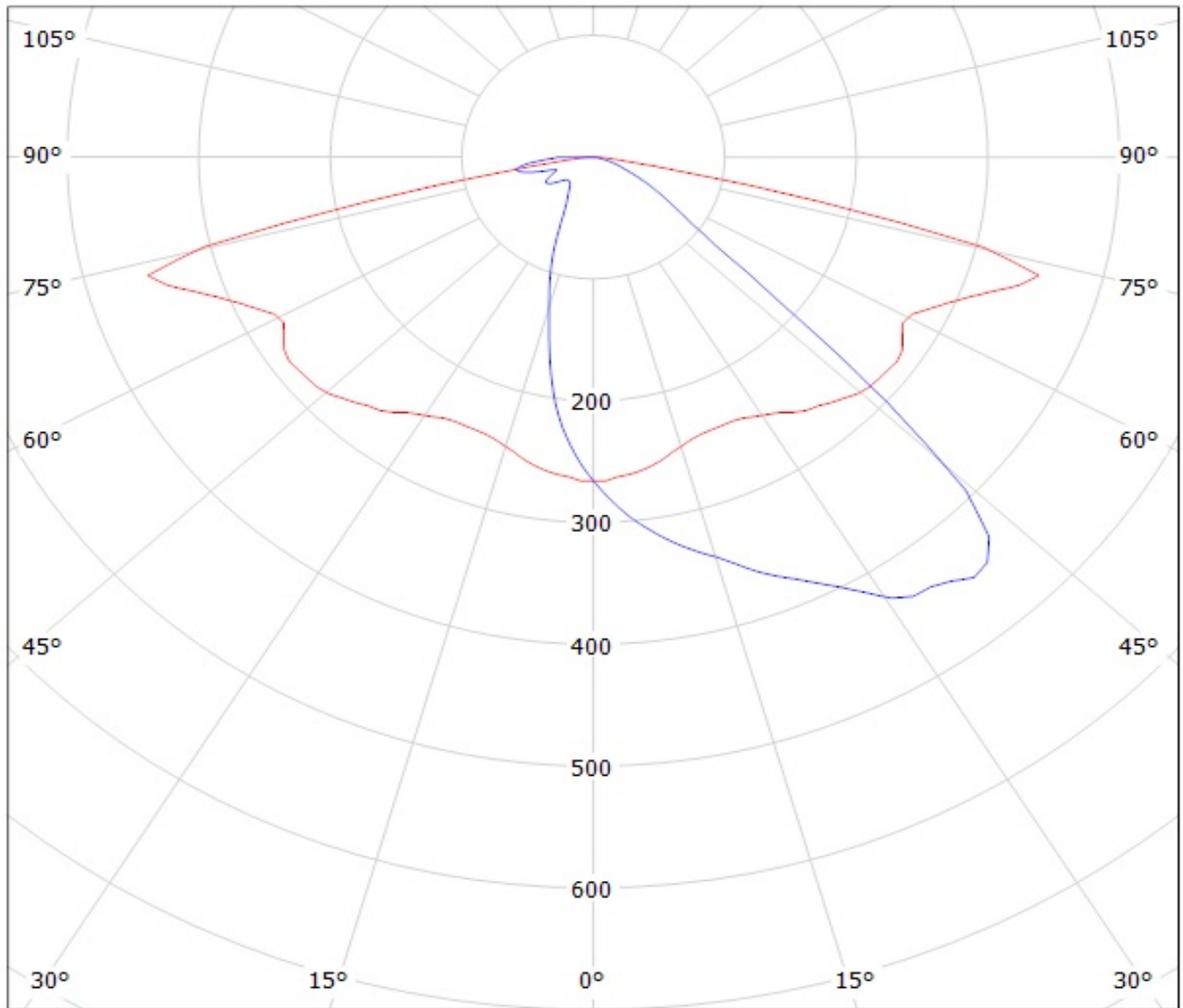

cd/klm

— C0 - C180 — C90 - C270

Luminaire: LEDil Oy C13299_STRADA-2X2-ME_(XM-L2) Efficiency=94%
Lamps: 1 x Cree XM-L2 (XMLBWT-0-7B4-T30-0L-0001) 356lm @ 250mA CCT=3200K P=2.8W I=250mA

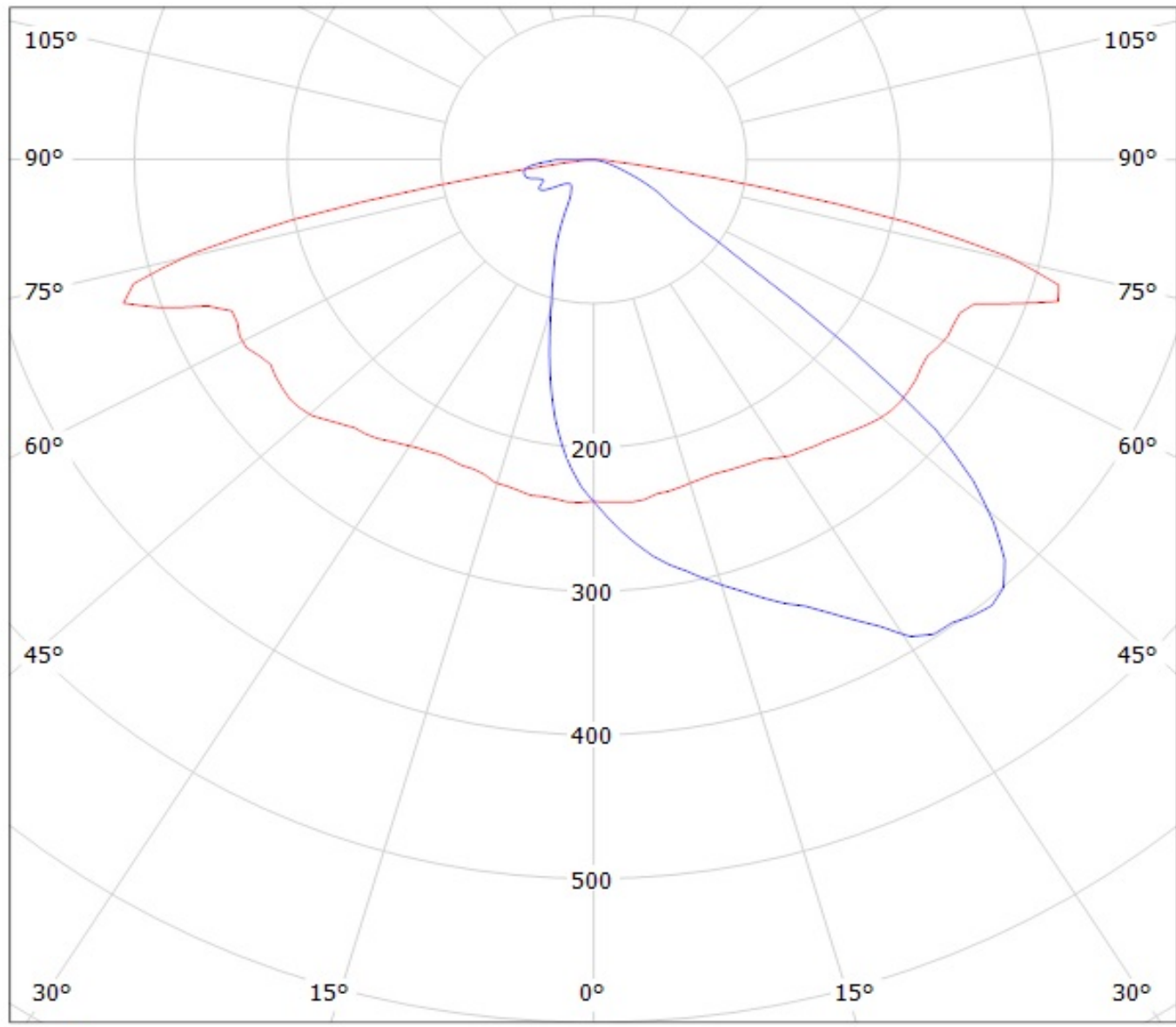

cd/klm
— C0 - C180 — C90 - C270

Luminaire: LEDiL Oy C13299_STRADA-2X2-ME_(XP-L)

Lamps: 1 x CREE_XP-L_2x2_(XPLAWT-0-1B0-V40-00-0001)_518.95lm@250mA_CCT=7600K_P=2.79963W_I=249.9mA

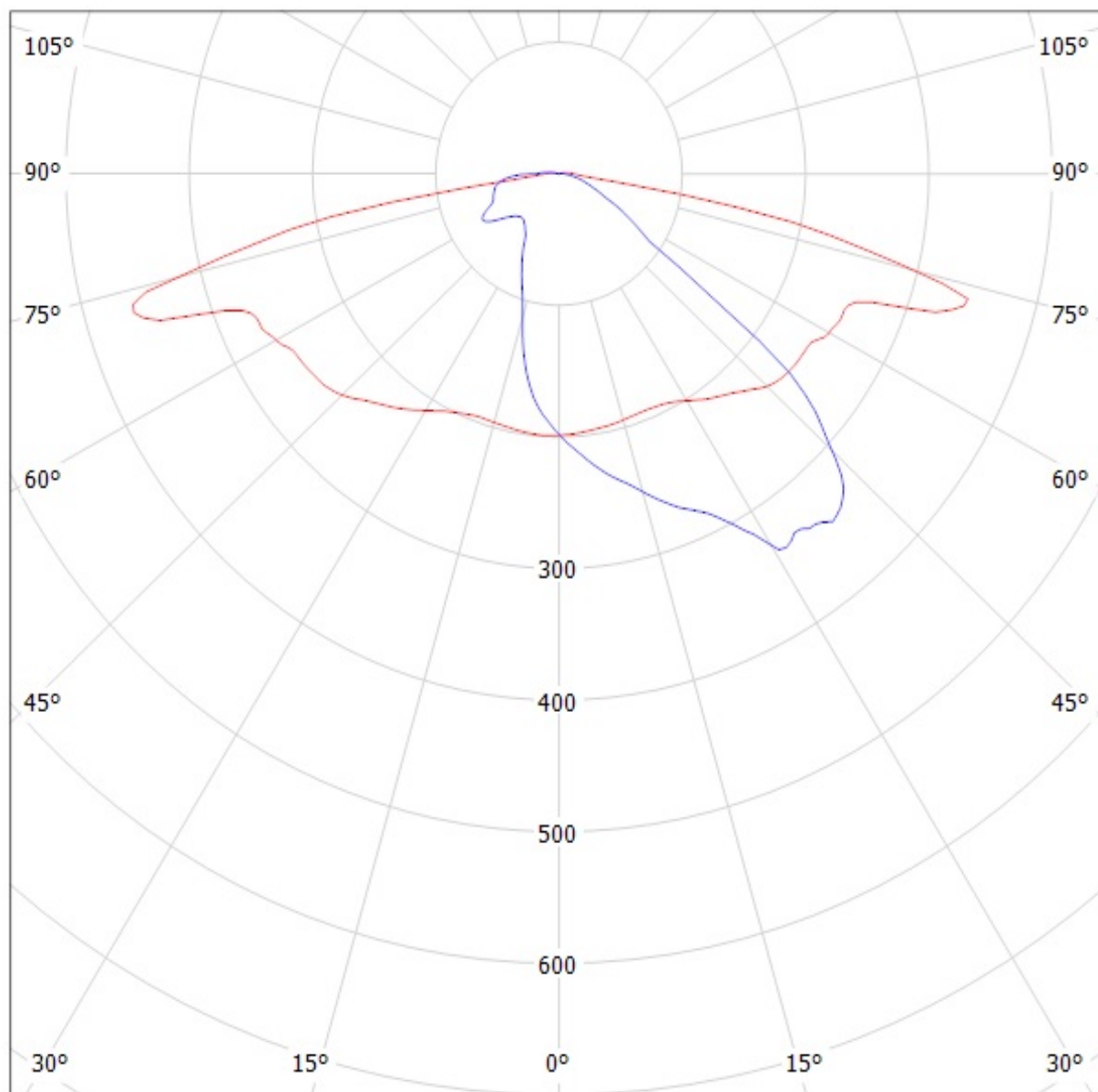

cd/klm

— C0 - C180 — C90 - C270

$\eta = 94\%$

Luminaire: LEDiL Oy C13299_STRADA-2X2-ME_(LUXEON_MZ) Eff.94.0%

Lamps: 1 x LUXEON_MZ_2x2_(LMZ7-QW57)_419.8lm@250mA_P=2.71916W_CCT=5700K_I=249.9mA

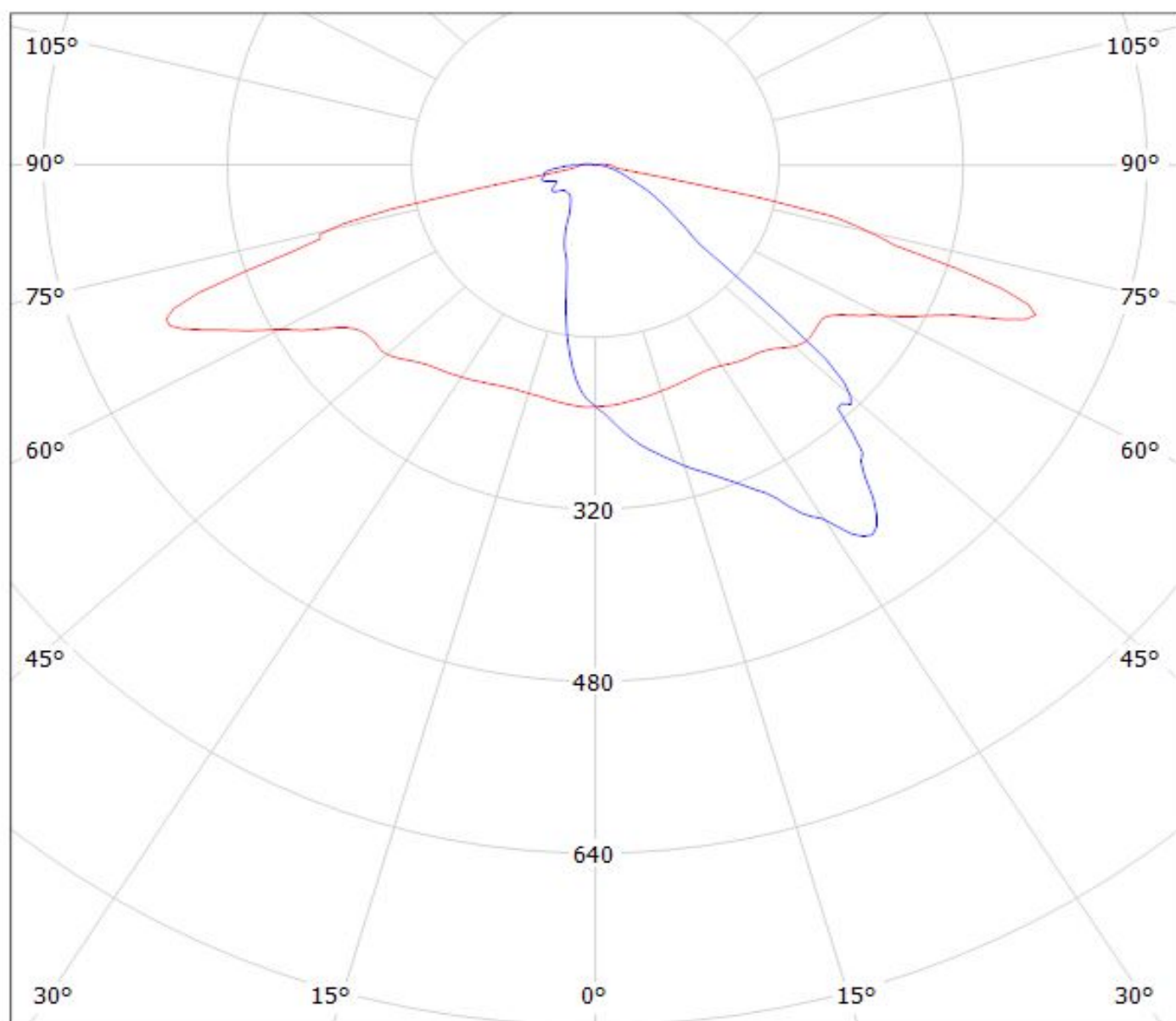

cd/klm

— C0 - C180

— C90 - C270

$\eta = 94\%$

Luminaire: LEDiL Oy C13299_STRADA-2x2-ME_(NVSxx19B)

Lamps: 1 x Nichia_NVsxx19B_2x2_(NVSL219BE)_310.219lm@250mA_CCT=3071K_P=2.87735W_I=249.9mA

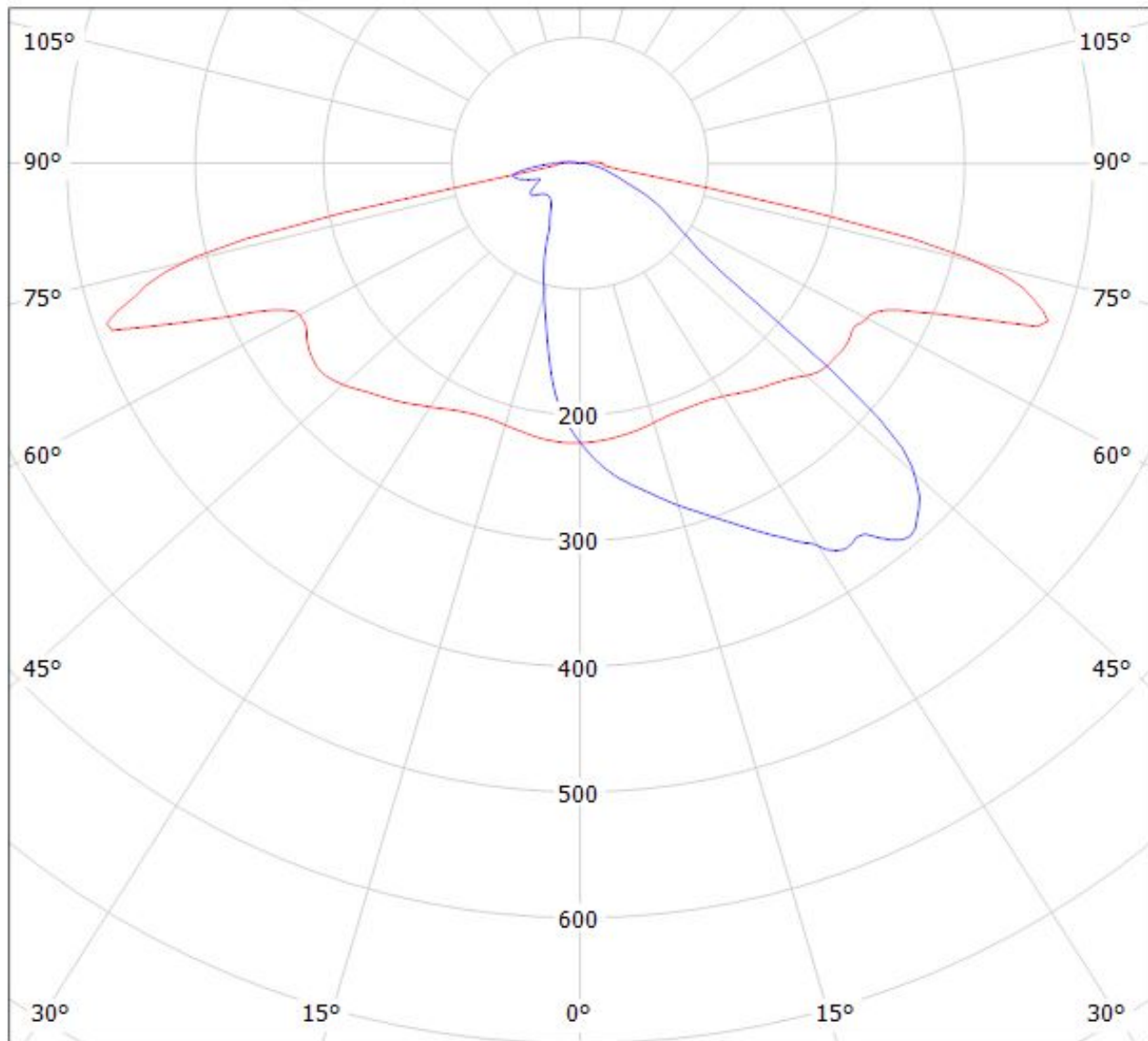

cd/klm

— C0 - C180

— C90 - C270

$\eta = 96\%$

Luminaire: LEDiL Oy C13299_STRADA-2X2-ME_(LH351B)

Lamps: 1 x SAMSUNG_LH351B_2x2_442.45lm@250mA_P=2.84311W_I=249.9mA

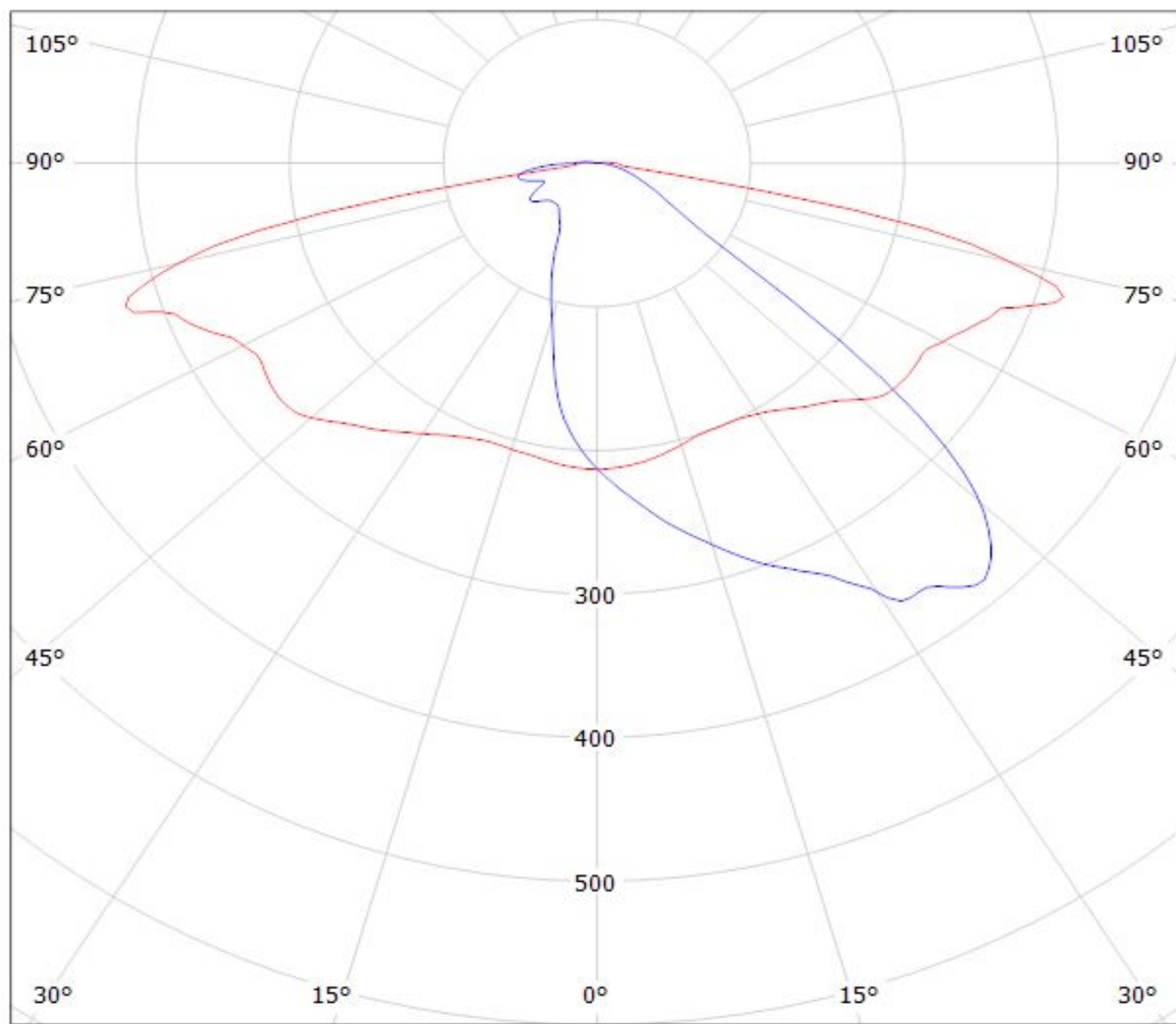

cd/klm

— C0 - C180

— C90 - C270

$\eta = 94\%$

Ledil C13299_STRADA-2X2-ME_(TL1L3) / LDC (Polar)

Luminaire: Ledil C13299_STRADA-2X2-ME_(TL1L3)

Lamps: 1 x Toshiba_TL1L3_2x2_(TL1L3-NW1.L)_387.773lm@250mA_CCT=5000K_P=2.829W_I=0.25A

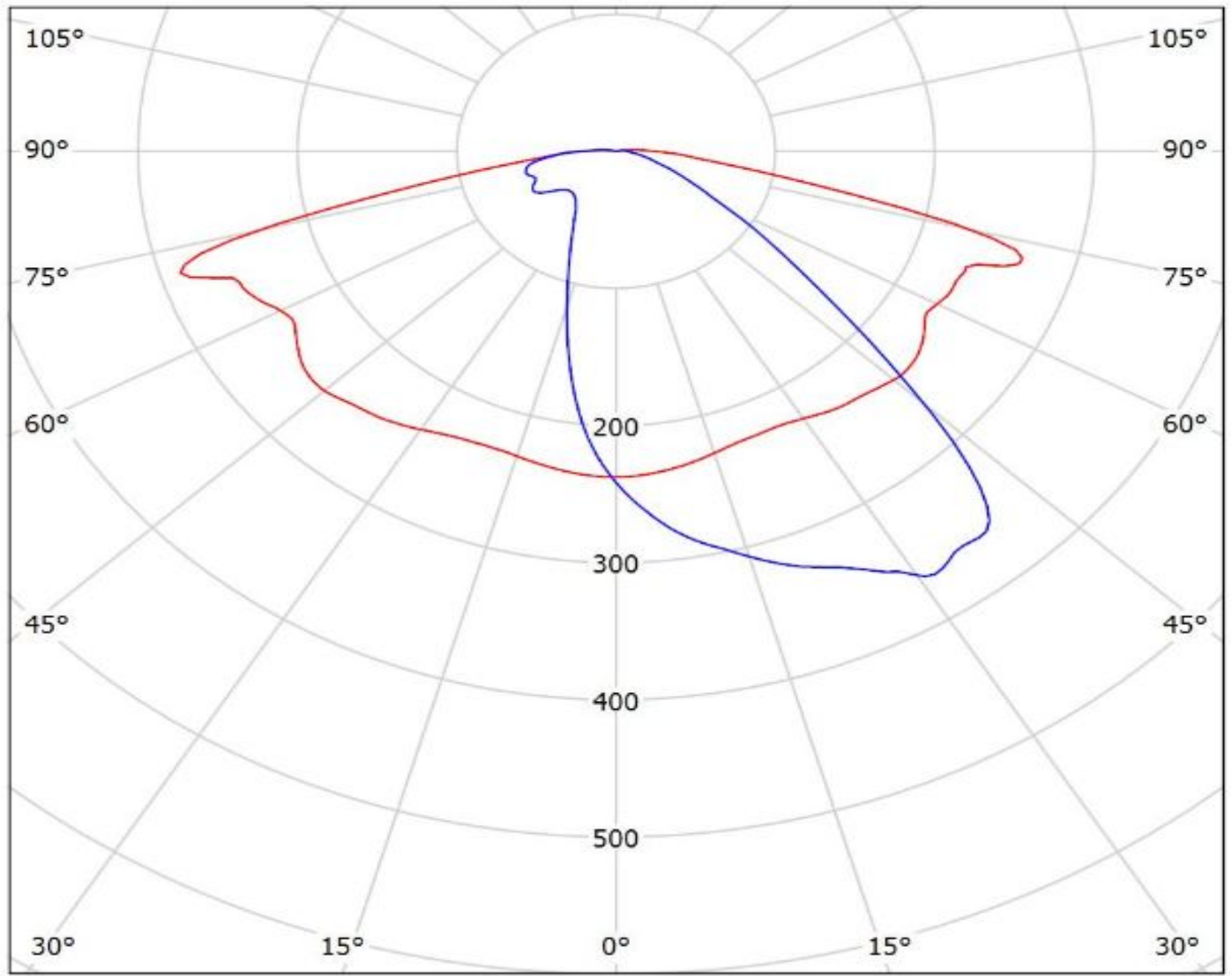

cd/klm

— C0 - C180

— C90 - C270

$\eta = 96\%$

Luminaire: Ledil C13299_STRADA-2X2-ME_(Luxeon_TX)

Lamps: 1 x Luxeon_TX_2x2_(L1T2-3585)_331.643lm@250mA_P=3W_I=0.25A

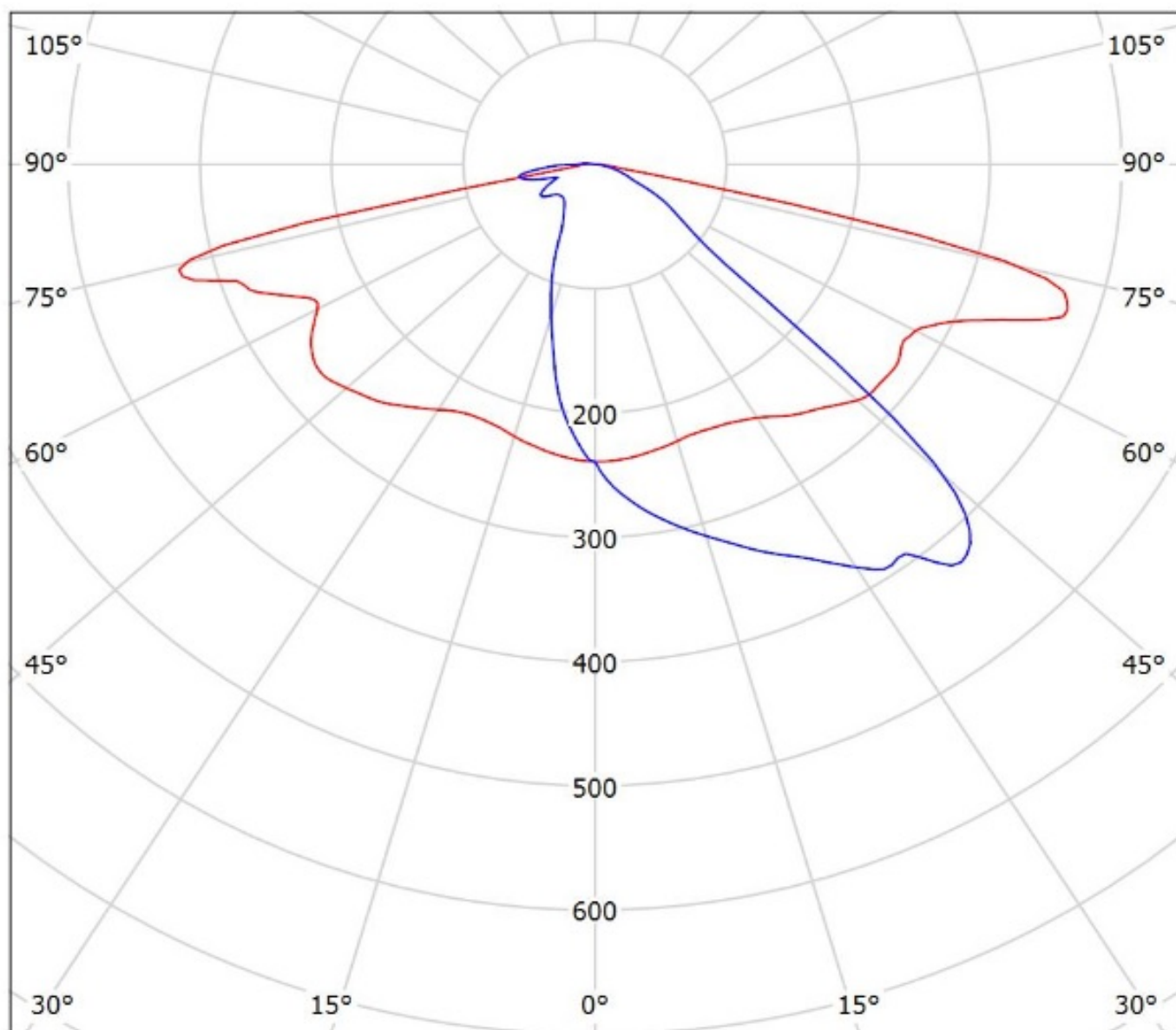

cd/klm

— C0 - C180

— C90 - C270

$\eta = 96\%$

Luminaire: LEDiL Oy C13299_STRADA-2X2-ME_(Fortimo_F-Flex_2x8_740DAG3)
Lamps: 1 x Philips_Fortimo_F-Flex_2x8_740DAG3_1786.86lm@250mA_P=11.6092W_I=0.2498A

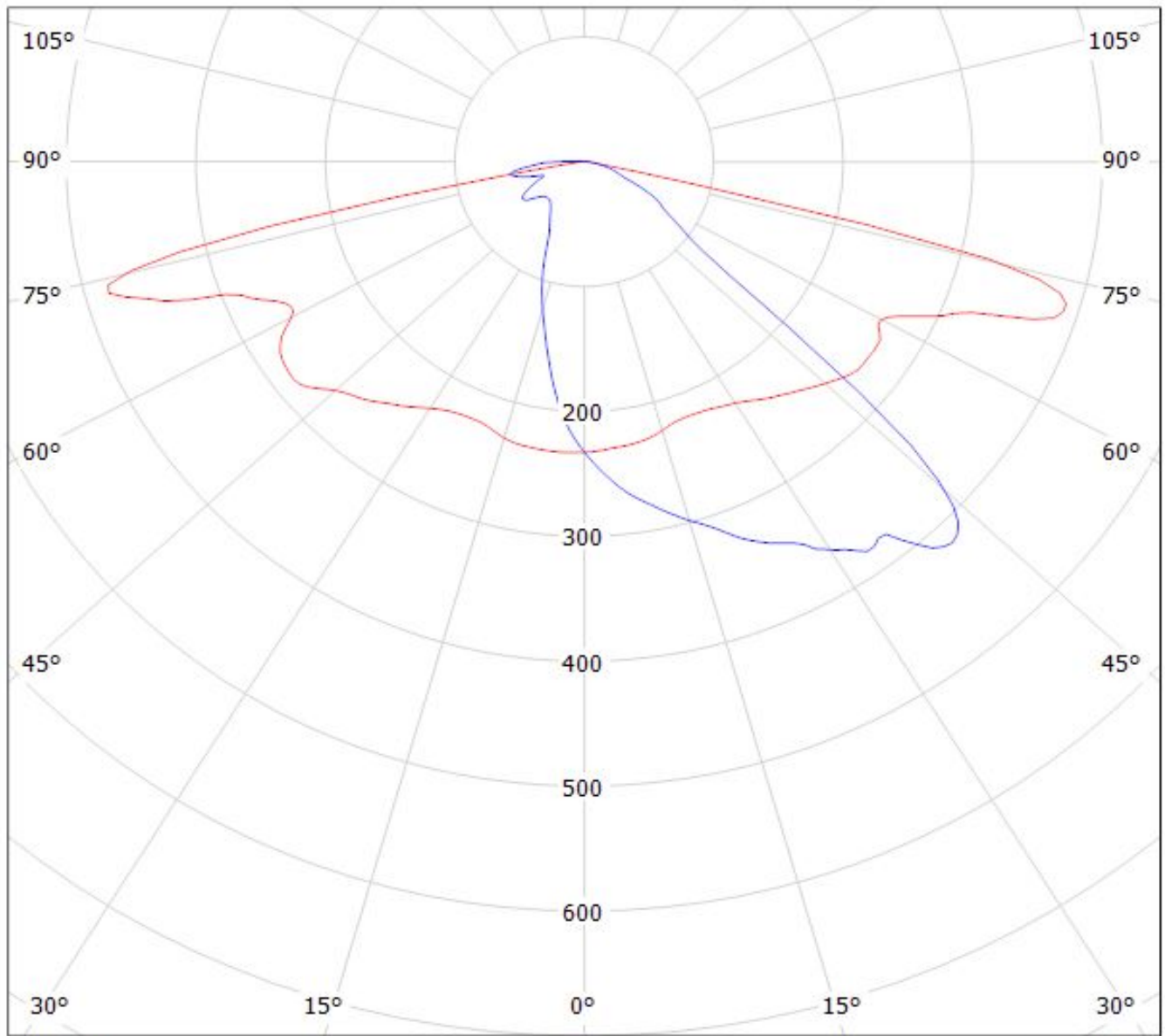

$\eta = 96\%$

cd/klm
— C0 - C180 — C90 - C270

Ledil C13299_STRADA-2X2-ME_(TL1L4) / LDC (Polar)

Luminaire: Ledil C13299_STRADA-2X2-ME_(TL1L4)

Lamps: 1 x Toshiba_TL1L4_2x2_(TL1L4-DW0)_472.639lm@250mA_CCT=6500K_P=2.9W_I=0.25A

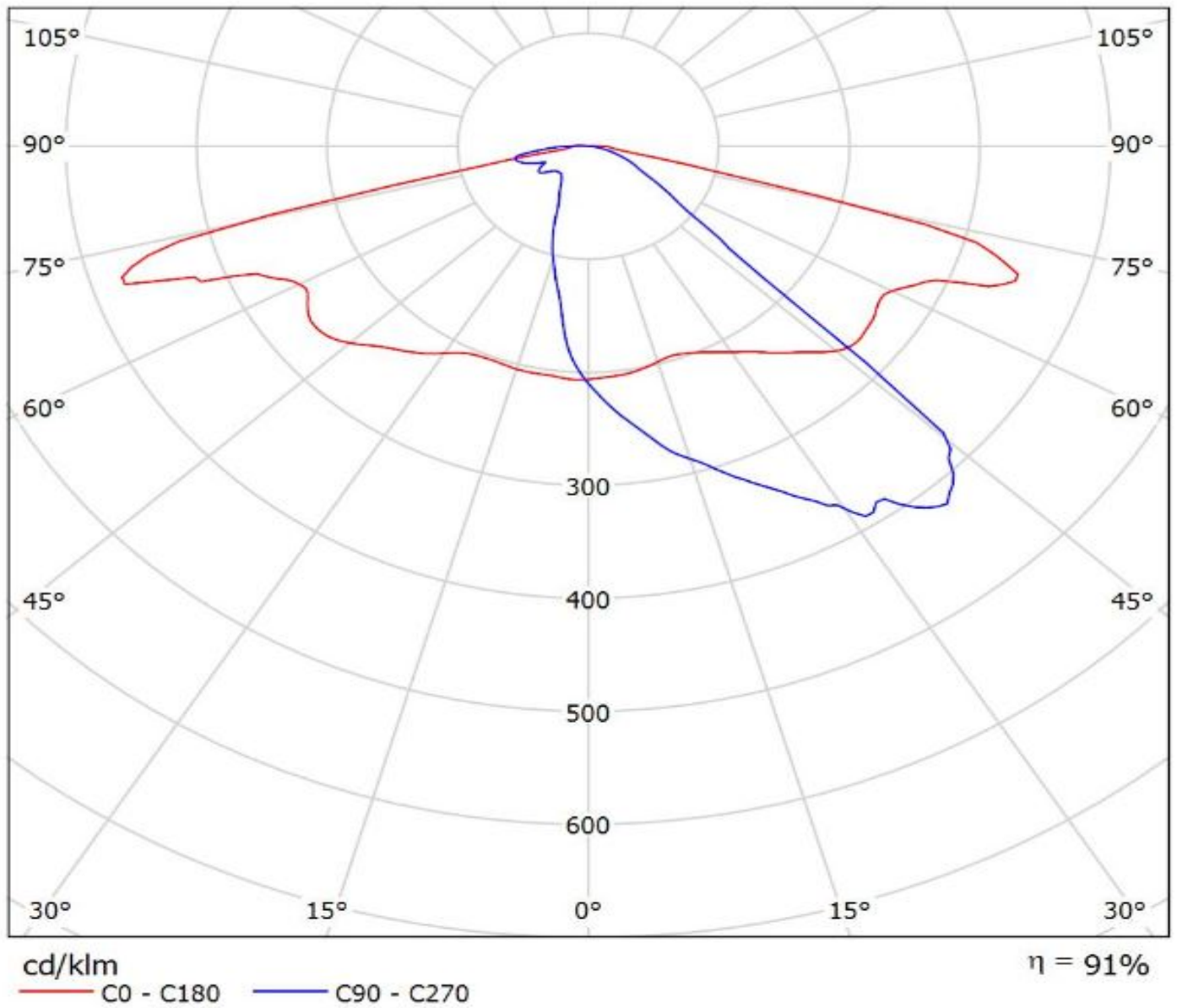

Luminaire: LEDiL Oy C13299_STRADA-2X2-ME_(XP-L_HI)
Lamps: 1 x Cree_XP-L_HI_(2x2)_(XPLAWT-H-5A3-U60-013-0001)
_455.077lm@250mA_P=2.84011W_I=0,2499A

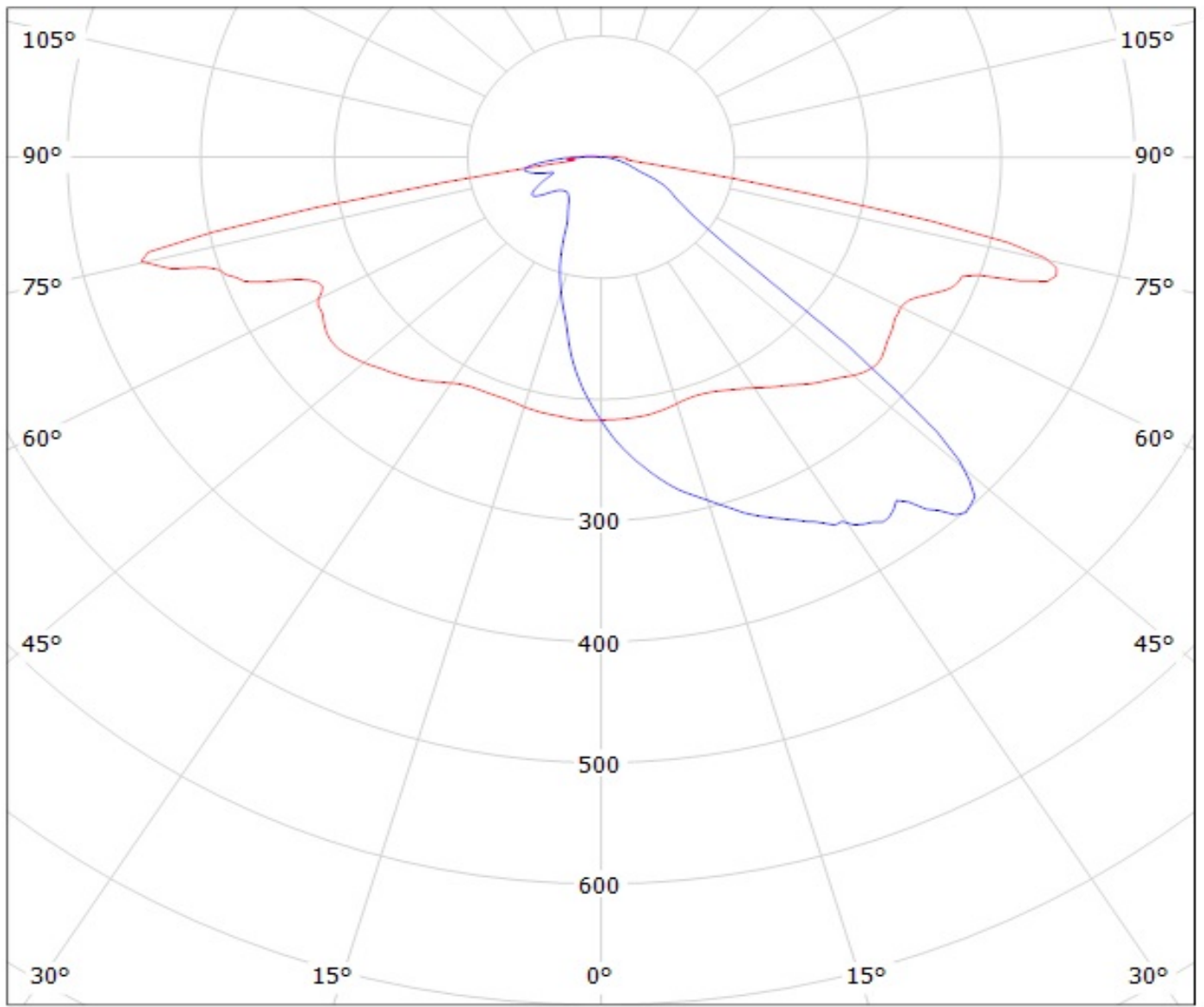

cd/klm

— C0 - C180 — C90 - C270

$\eta = 96\%$

Luminaire: LEDiL Oy C13299_STRADA-2X2-ME_(Square_Gen3)

Lamps: 1 x Osram_Square_Gen3_GW_CSSRM2.PM_451.664lm@250mA_P=2.787_I=250mA

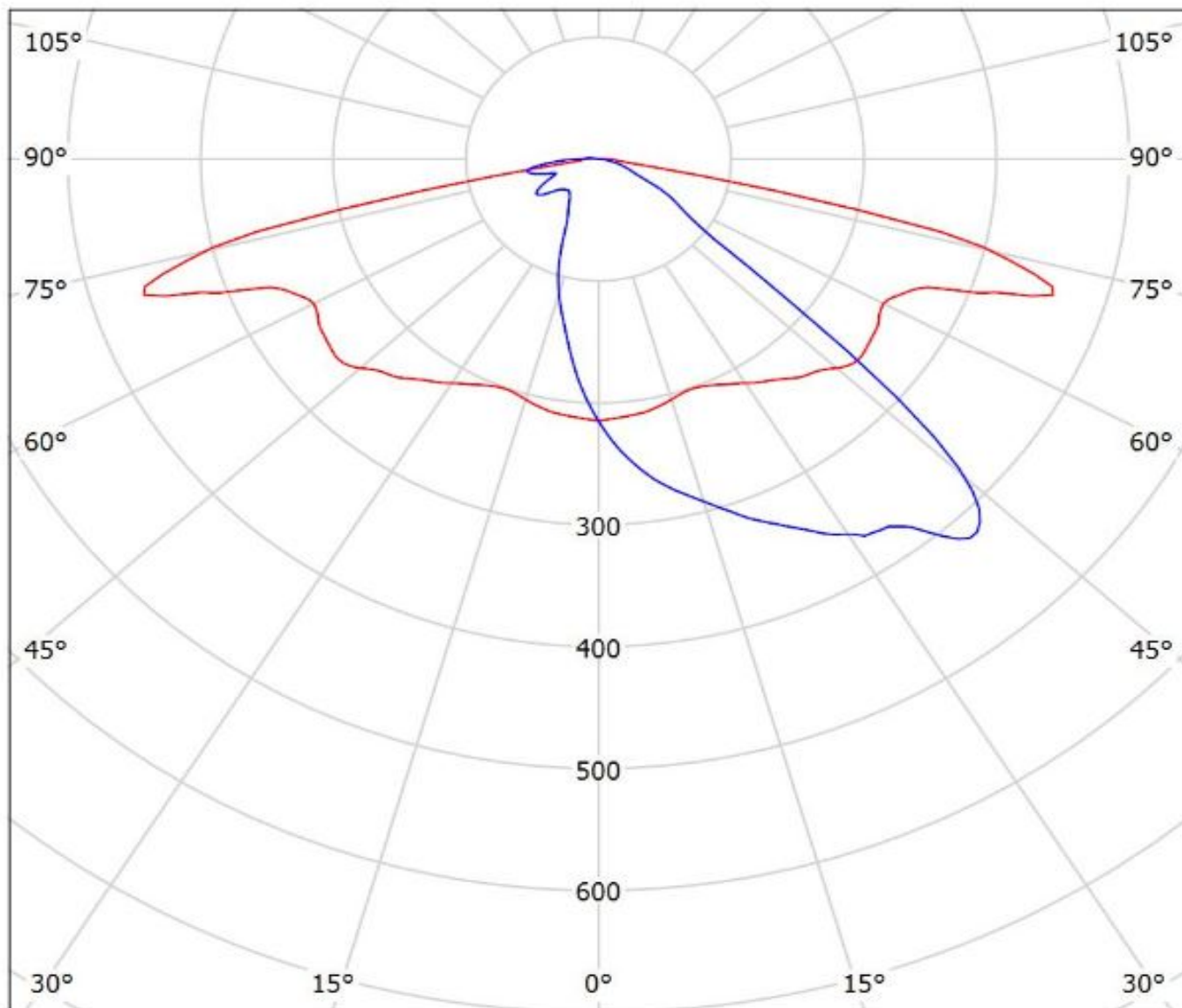

cd/klm

— C0 - C180 — C90 - C270

$\eta = 93\%$

NOTE: The typical divergence will be changed by different color, chip size and chip position tolerance. The typical total divergence is the full angle measured where the luminous intensity is half of the peak value.