

### HEXFET® Power MOSFET

- Dynamic dv/dt Rating
- Repetitive Avalanche Rated
- P-Channel
- Isolated Central Mounting Hole
- 175°C Operating Temperature
- Fast Switching
- Ease of Paralleling

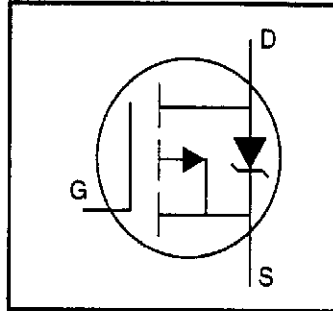

$$V_{DSS} = -100V$$

$$R_{DS(on)} = 0.20\Omega$$

$$I_D = -21A$$

### Description

Third Generation HEXFETs from International Rectifier provide the designer with the best combination of fast switching, ruggedized device design, low on-resistance and cost-effectiveness.

The TO-247 package is preferred for commercial–industrial applications where higher power levels preclude the use of TO-220 devices. The TO-247 is similar but superior to the earlier TO-218 package because of its isolated mounting hole. It also provides greater creepage distance between pins to meet the requirements of most safety specifications.

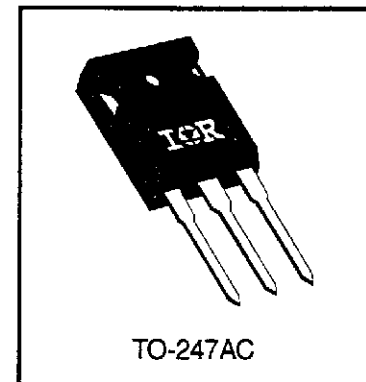

### Absolute Maximum Ratings

	Parameter	Max.	Units
$I_D @ T_C = 25^\circ C$	Continuous Drain Current, $V_{GS} @ -10 V$	-21	A
$I_D @ T_C = 100^\circ C$	Continuous Drain Current, $V_{GS} @ -10 V$	-15	
$I_{DM}$	Pulsed Drain Current ①	-84	
$P_D @ T_C = 25^\circ C$	Power Dissipation	180	W
	Linear Derating Factor	1.2	W/°C
$V_{GS}$	Gate-to-Source Voltage	$\pm 20$	V
$E_{AS}$	Single Pulse Avalanche Energy ②	960	mJ
$I_{AR}$	Avalanche Current ①	-21	A
$E_{AR}$	Repetitive Avalanche Energy ①	18	mJ
dv/dt	Peak Diode Recovery dv/dt ③	-5.5	V/ns
$T_J$ $T_{STG}$	Operating Junction and Storage Temperature Range	-55 to +175	°C
	Soldering Temperature, for 10 seconds	300 (1.6mm from case)	
	Mounting Torque, 6-32 or M3 screw	10 lbf·in (1.1 N·m)	

### Thermal Resistance

	Parameter	Min.	Typ.	Max.	Units
$R_{\theta JC}$	Junction-to-Case	—	—	0.83	°C/W
$R_{\theta CS}$	Case-to-Sink, Flat, Greased Surface	—	0.24	—	
$R_{\theta JA}$	Junction-to-Ambient	—	—	40	

**Electrical Characteristics @  $T_J = 25^\circ\text{C}$  (unless otherwise specified)**

	Parameter	Min.	Typ.	Max.	Units	Test Conditions
$V_{(BR)DSS}$	Drain-to-Source Breakdown Voltage	-100	—	—	V	$V_{GS}=0\text{V}$ , $I_D=-250\mu\text{A}$
$\Delta V_{(BR)DSS}/\Delta T_J$	Breakdown Voltage Temp. Coefficient	—	-0.087	—	V/ $^\circ\text{C}$	Reference to $25^\circ\text{C}$ , $I_D=-1\text{mA}$
$R_{DS(on)}$	Static Drain-to-Source On-Resistance	—	—	0.20	$\Omega$	$V_{GS}=-10\text{V}$ , $I_D=-13\text{A}$ ④
$V_{GS(th)}$	Gate Threshold Voltage	-2.0	—	-4.0	V	$V_{DS}=V_{GS}$ , $I_D=-250\mu\text{A}$
$g_{fs}$	Forward Transconductance	6.2	—	—	S	$V_{DS}=-50\text{V}$ , $I_D=-13\text{A}$ ④
$I_{DSS}$	Drain-to-Source Leakage Current	—	—	-100	$\mu\text{A}$	$V_{DS}=-100\text{V}$ , $V_{GS}=0\text{V}$
		—	—	-500		$V_{DS}=-80\text{V}$ , $V_{GS}=0\text{V}$ , $T_J=150^\circ\text{C}$
$I_{GSS}$	Gate-to-Source Forward Leakage	—	—	-100	nA	$V_{GS}=-20\text{V}$
	Gate-to-Source Reverse Leakage	—	—	100		$V_{GS}=20\text{V}$
$Q_g$	Total Gate Charge	—	—	61	nC	$I_D=-19\text{A}$
$Q_{gs}$	Gate-to-Source Charge	—	—	14		$V_{DS}=-80\text{V}$
$Q_{gd}$	Gate-to-Drain ("Miller") Charge	—	—	29		$V_{GS}=-10\text{V}$ See Fig. 6 and 13 ④
$t_{d(on)}$	Turn-On Delay Time	—	16	—	ns	$V_{DD}=-50\text{V}$
$t_r$	Rise Time	—	73	—		$I_D=-19\text{A}$
$t_{d(off)}$	Turn-Off Delay Time	—	34	—		$R_G=9.1\Omega$
$t_f$	Fall Time	—	57	—		$R_D=2.4\Omega$ See Figure 10 ④
$L_D$	Internal Drain Inductance	—	5.0	—	nH	Between lead, 6 mm (0.25in.) from package and center of die contact
$L_S$	Internal Source Inductance	—	13	—		
$C_{iss}$	Input Capacitance	—	1400	—	pF	$V_{GS}=0\text{V}$
$C_{oss}$	Output Capacitance	—	590	—		$V_{DS}=-25\text{V}$
$C_{rss}$	Reverse Transfer Capacitance	—	140	—		$f=1.0\text{MHz}$ See Figure 5

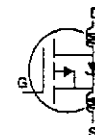
**Source-Drain Ratings and Characteristics**

	Parameter	Min.	Typ.	Max.	Units	Test Conditions
$I_S$	Continuous Source Current (Body Diode)	—	—	-21	A	MOSFET symbol showing the integral reverse p-n junction diode.
$I_{SM}$	Pulsed Source Current (Body Diode) ①	—	—	-84		
$V_{SD}$	Diode Forward Voltage	—	—	-5.0	V	$T_J=25^\circ\text{C}$ , $I_S=-21\text{A}$ , $V_{GS}=0\text{V}$ ④
$t_{rr}$	Reverse Recovery Time	—	130	260	ns	$T_J=25^\circ\text{C}$ , $I_F=-19\text{A}$
$Q_{rr}$	Reverse Recovery Charge	—	0.35	0.70	$\mu\text{C}$	$di/dt=100\text{A}/\mu\text{s}$ ④
$t_{on}$	Forward Turn-On Time	Intrinsic turn-on time is negligible (turn-on is dominated by $L_S+L_D$ )				

**Notes:**

- ① Repetitive rating; pulse width limited by max. junction temperature (See Figure 11)
- ②  $V_{DD}=-25\text{V}$ , starting  $T_J=25^\circ\text{C}$ ,  $L=3.3\text{mH}$ ,  $R_G=25\Omega$ ,  $I_{AS}=-21\text{A}$  (See Figure 12)
- ③  $I_{SD}\leq-21\text{A}$ ,  $di/dt\leq 200\text{A}/\mu\text{s}$ ,  $V_{DD}\leq V_{(BR)DSS}$ ,  $T_J\leq 175^\circ\text{C}$
- ④ Pulse width  $\leq 300\mu\text{s}$ ; duty cycle  $\leq 2\%$ .

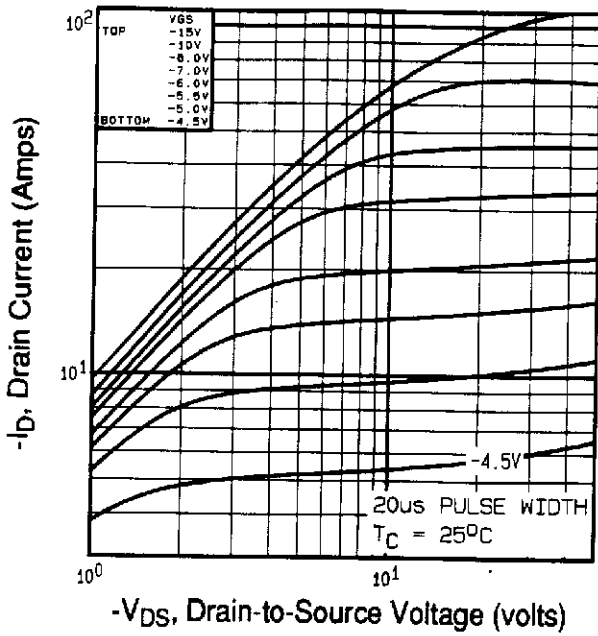

**Fig 1.** Typical Output Characteristics,  $T_C = 25^\circ\text{C}$

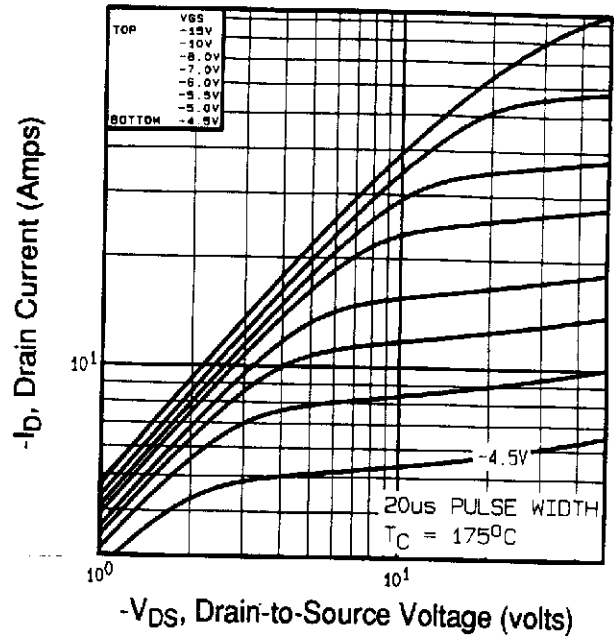

**Fig 2.** Typical Output Characteristics,  $T_C = 175^\circ\text{C}$

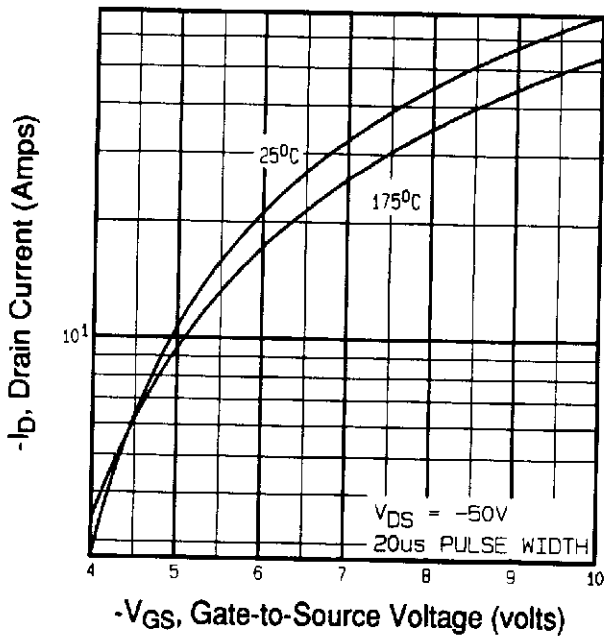

**Fig 3.** Typical Transfer Characteristics

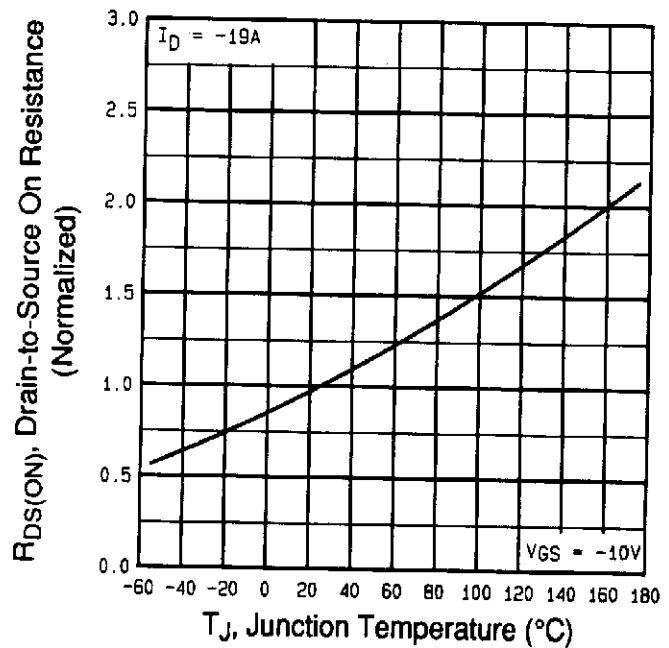

**Fig 4.** Normalized On-Resistance Vs. Temperature

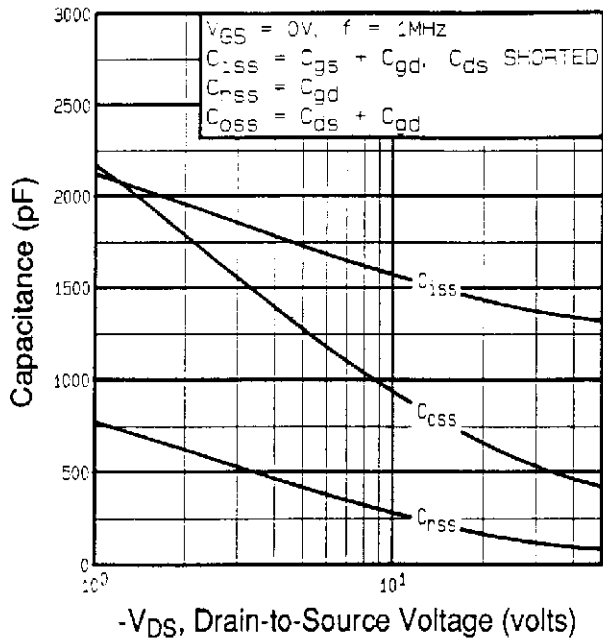

**Fig 5.** Typical Capacitance Vs. Drain-to-Source Voltage

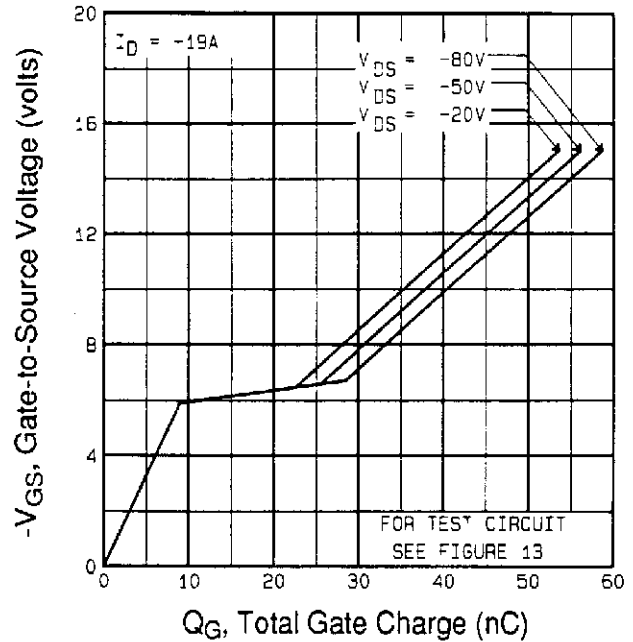

**Fig 6.** Typical Gate Charge Vs. Gate-to-Source Voltage

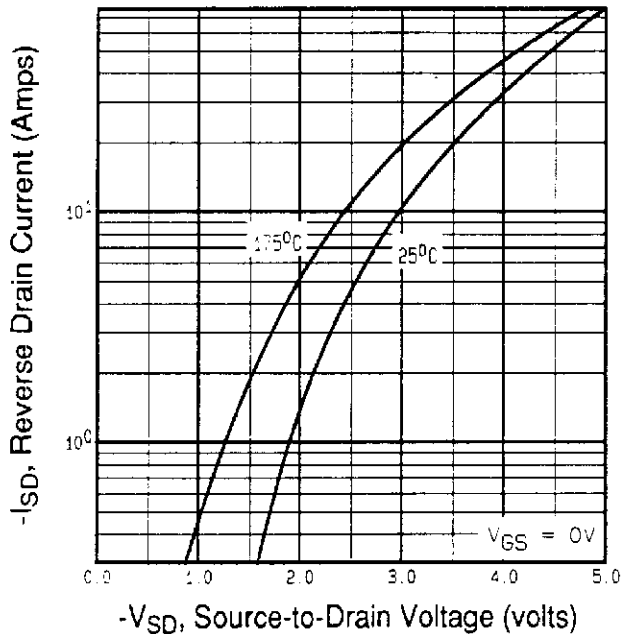

**Fig 7.** Typical Source-Drain Diode Forward Voltage

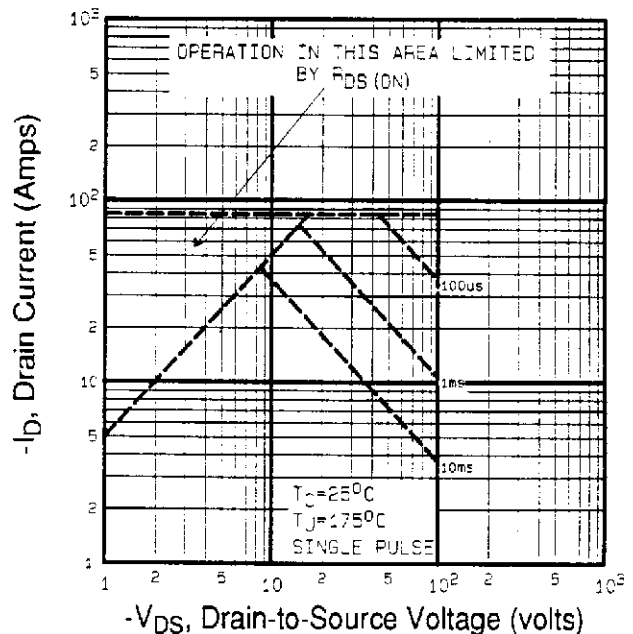

**Fig 8.** Maximum Safe Operating Area

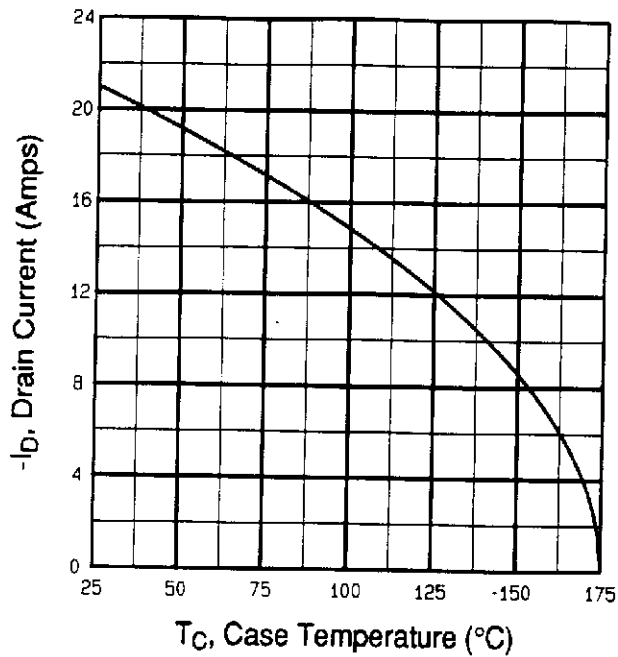

**Fig 9.** Maximum Drain Current Vs. Case Temperature

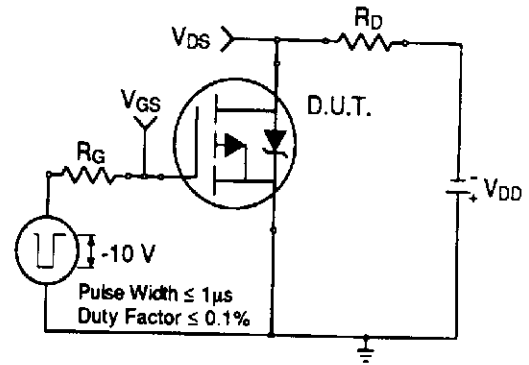

**Fig 10a.** Switching Time Test Circuit

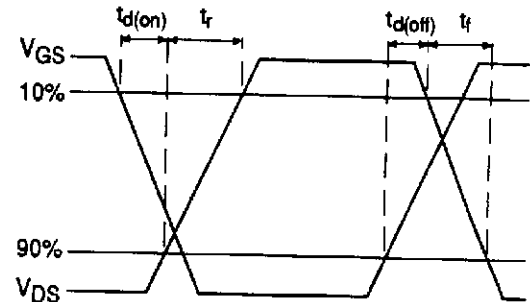

**Fig 10b.** Switching Time Waveforms

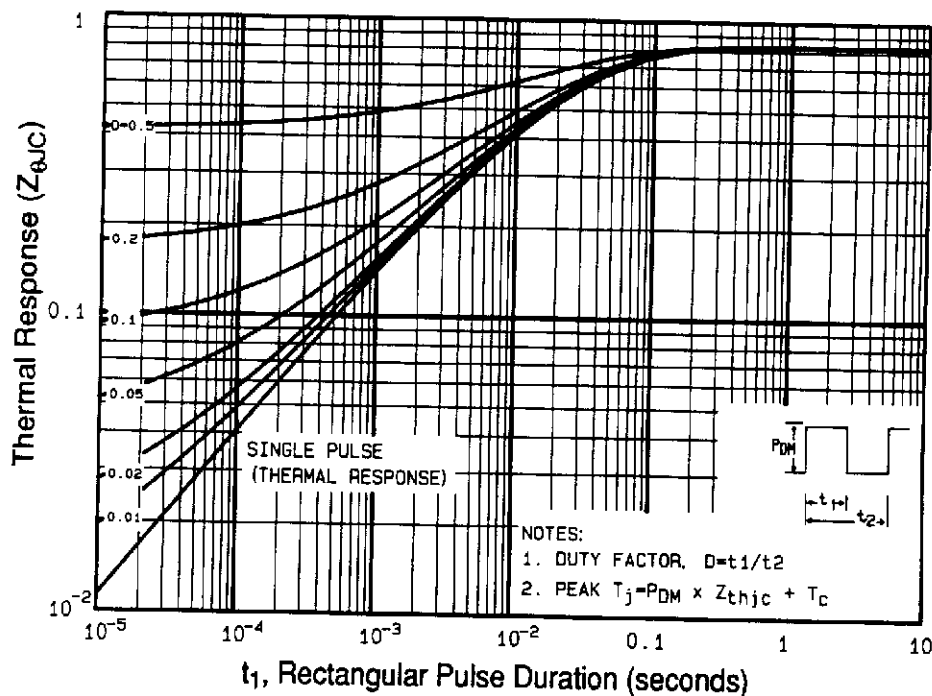

**Fig 11.** Maximum Effective Transient Thermal Impedance, Junction-to-Case

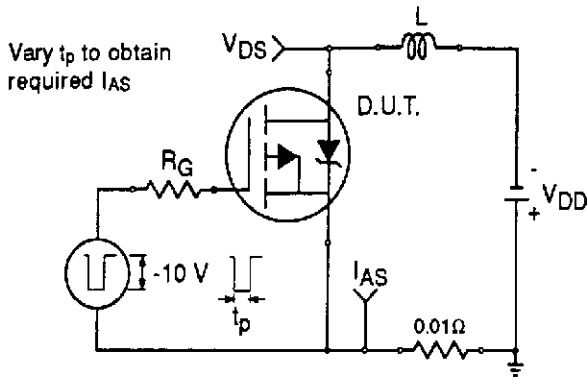

**Fig 12a.** Unclamped Inductive Test Circuit

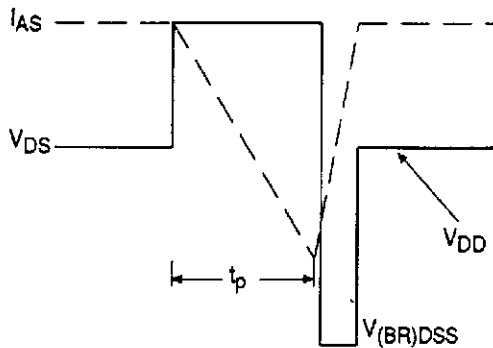

**Fig 12b.** Unclamped Inductive Waveforms

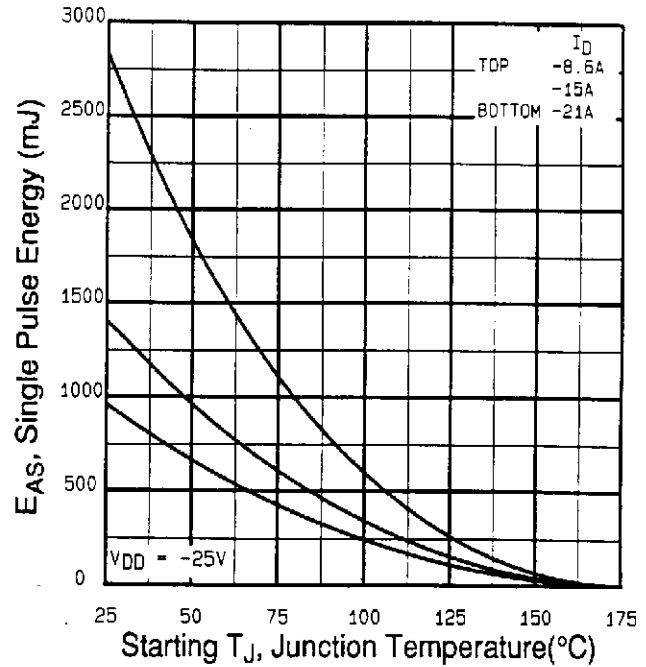

**Fig 12c.** Maximum Avalanche Energy Vs. Drain Current

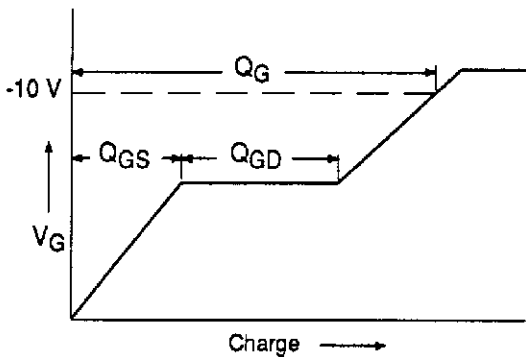

**Fig 13a.** Basic Gate Charge Waveform

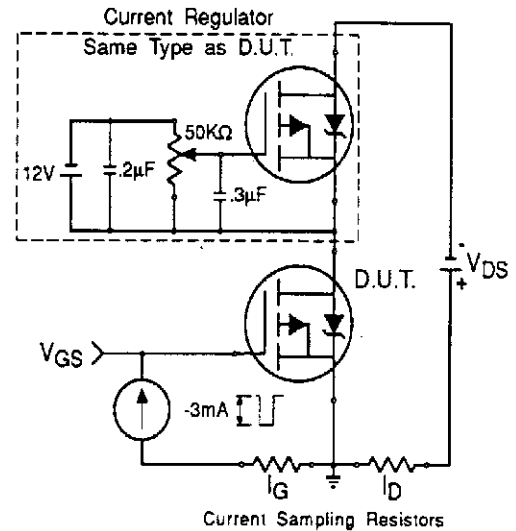

**Fig 13b.** Gate Charge Test Circuit

**Appendix A:** Figure 14, Peak Diode Recovery  $dv/dt$  Test Circuit – See page 1506

**Appendix B:** Package Outline Mechanical Drawing – See page 1511

**Appendix C:** Part Marking Information – See page 1517