

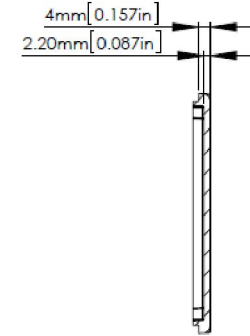

RS Stock No.1465296

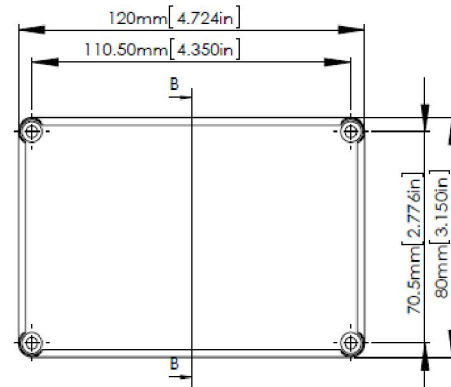

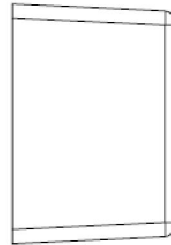
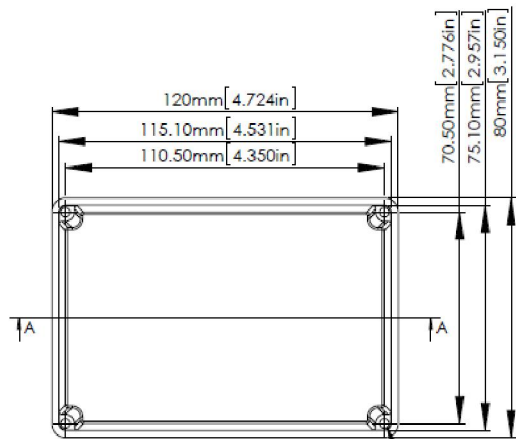

SECTION B-B
SCALE 2 : 3

FOUR (4) #6-32X5/8"
SELF-TAPPING SCREWS.

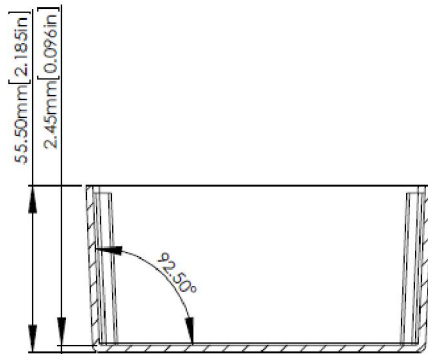
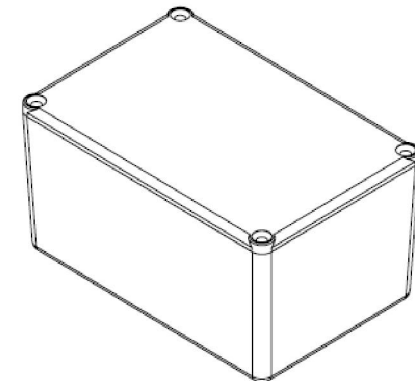

SECTION A-A
SCALE 2 : 3

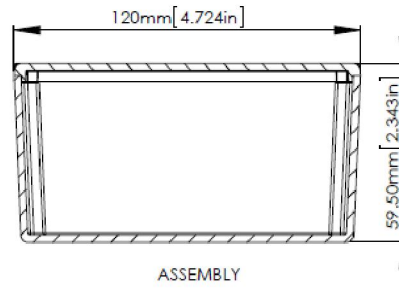

ASSEMBLY

According to ISO 2768-m

Measuring DIM=L	Tolerances
0.5<L<=3.0mm	±0.1mm
3.0<L<=6.0 mm	±0.1mm
6.0<L<=30.0 mm	±0.2mm
30.0<L<=120.0 mm	±0.3mm
120.0<L<=400.0 mm	±0.5mm
400.0<L<=1000.0 mm	±0.8mm