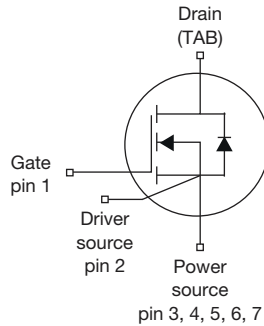
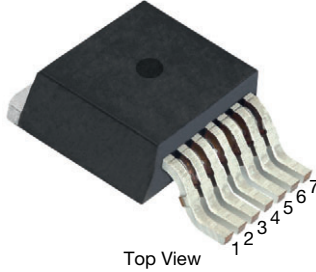

MaxSiC[®] 1200 V N-Channel SiC MOSFET

D²PAK 7L (TO-263 7L)

Marking Code: Q120A045SE

PRODUCT SUMMARY	
V _{DS} (V) at T _J max.	1200
R _{DS(on)} typ. (mΩ) at 25 °C	V _{GS} = 18 V 45
Q _g typ. (nC)	82
I _D (A)	52
C _{oss} typ. (pF)	91
P _D (W)	268
Configuration	Single

ORDERING INFORMATION	
Package	D ² PAK 7L (TO-263 7L)
Lead (Pb)-free and halogen-free	MXPQ120A045SE-1GE3

ABSOLUTE MAXIMUM RATINGS (T _C = 25 °C, unless otherwise noted)				
PARAMETER		SYMBOL	LIMIT	UNIT
Drain-source voltage		V _{DS}	1200	V
Gate-source voltage		V _{GS}	-10 / +22	
Recommended operation voltage of gate-source		V _{GSOP}	-5 to -3 / +18	
Continuous drain current	T _C = 25 °C	I _D	52	A
Pulsed drain current ^a		I _{DM}	104	
Short-circuit withstand time ^b		T _{SC}	3	μs
Maximum power dissipation	T _C = 25 °C	P _D	268	W
Operating junction and storage temperature range		T _J , T _{stg}	-55 to +175	°C
Soldering recommendations (peak temperature)	For 10 s		260	°C
Single pulse avalanche energy ^c		E _{AS}	200	mJ

Notes

- Repetitive rating; pulse width limited by maximum junction temperature
- V_{GS} = 18 V, V_{DS} = 800 V, R_{g(ext)} = 20 Ω, verified by the design / characterization
- T_J = 25 °C, V_{DD} = 120 V, L = 1 mH, V_{GS} = 18 V, I_{AS} = 20 A

FEATURES

- AEC-Q101 qualified
- Fast switching speed
- Short circuit withstand time 3 μs
- Material categorization: for definitions of compliance please see www.vishay.com/doc?99912

APPLICATIONS

- Automotive on board charger
- Automotive DC/DC converter for EV/HEV
- Auxiliary drives
- EV Charging

AUTOMOTIVE GRADE

RoHS
 COMPLIANT
 HALOGEN
FREE



THERMAL RESISTANCE RATINGS				
PARAMETER	SYMBOL	TYP.	MAX.	UNIT
Maximum junction-to-ambient	R _{thJA}	-	42	°C/W
Maximum junction-to-case (drain)	R _{thJC}	-	0.56	

SPECIFICATIONS (T _J = 25 °C, unless otherwise noted)							
PARAMETER	SYMBOL	TEST CONDITIONS	MIN.	TYP.	MAX.	UNIT	
Static							
Drain-source breakdown voltage	V _{DS}	V _{GS} = 0 V, I _D = 1 mA	1200	-	-	V	
Gate-source threshold voltage (N)	V _{GS(th)}	V _{DS} = V _{GS} , I _D = 5 mA	-	2.8	-	V	
		V _{DS} = V _{GS} , I _D = 5 mA, T _J = 175 °C	-	1.9	-	V	
Gate-source leakage	I _{GSS}	V _{GS} = 22 V, V _{DS} = 0 V	-	-	100	nA	
		V _{GS} = -10 V, V _{DS} = 0 V	-	-	-100		
Zero gate voltage drain current	I _{DSS}	V _{DS} = 1200 V, V _{GS} = 0 V	-	-	10	µA	
Drain-source on-state resistance	R _{DS(on)}	V _{GS} = 15 V, I _D = 26 A	-	60	75	mΩ	
		V _{GS} = 18 V, I _D = 26 A	-	45	56		
		V _{GS} = 18 V, I _D = 26 A, T _J = 175 °C	-	82	-		
Transconductance	g _{fs}	V _{DS} = 10 V, I _D = 26 A	-	10	-	S	
Dynamic							
Input capacitance	C _{iss}	V _{GS} = 0 V, V _{DS} = 800 V, f = 100 KHz	-	2483	-	pF	
Output capacitance	C _{oss}		-	91	-		
Reverse transfer capacitance	C _{rss}		-	3	-		
Total gate charge	Q _g	V _{GS} = -5 V ~ 18 V, I _D = 26 A, V _{DS} = 800 V	-	82	-	nC	
Gate-source charge	Q _{gs}		-	25	-		
Gate-drain charge	Q _{gd}		-	22	-		
Gate Resistance	R _g		V _{DS} = 0 V, f = 1 MHz	-	3		-
Switching Characteristics							
Turn-on delay time	t _{d(on)}	V _{GS} = -5 V ~ 18 V, I _D = 26 A, V _{DS} = 800 V, R _{g(ext)} = 4.4 Ω	T _J = 25 °C	-	23	-	ns
			T _J = 175 °C	-	22	-	
Rise time	t _r		T _J = 25 °C	-	12	-	
			T _J = 175 °C	-	11	-	
Turn-off delay time	t _{d(off)}		T _J = 25 °C	-	25	-	
			T _J = 175 °C	-	27	-	
Fall time	t _f		T _J = 25 °C	-	10	-	
			T _J = 175 °C	-	10	-	
Turn-on switching energy	E _{on}		T _J = 25 °C	-	273	-	µJ
			T _J = 175 °C	-	261	-	
Turn-off switching energy	E _{off}		T _J = 25 °C	-	74	-	
			T _J = 175 °C	-	73	-	
Body Diode Ratings and Characteristic							
Forward diode voltage	V _{SD}	V _{GS} = -5 V, I _{SD} = 13 A, T _J = 25 °C	-	4.9	-	V	
Continuous diode forward current	I _{SD}	V _{GS} = -5 V, T _J = 25 °C	-	-	38	A	
Pulsed diode forward current	I _{SDM}		-	-	104		
Reverse recovery time	t _{rr}	V _{GS} = -5 V, I _{SD} = 26 A, V _R = 800 V, di/dt = 1000 A/µs	-	19	-	ns	
Reverse recovery charge	Q _{rr}		-	83	-	nC	
Reverse recovery current	I _{RRM}		-	7	-	A	

TYPICAL CHARACTERISTICS (25 °C, unless otherwise noted)

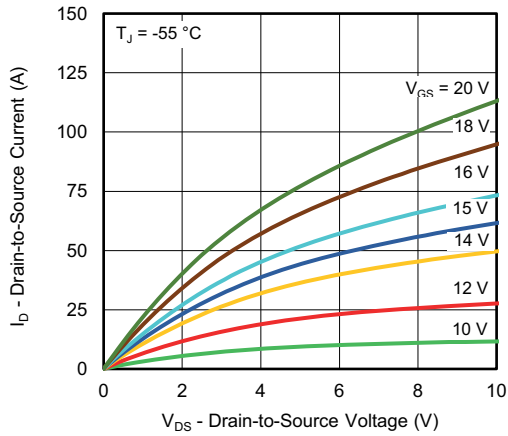

Fig. 1 - Typical Output Characteristics

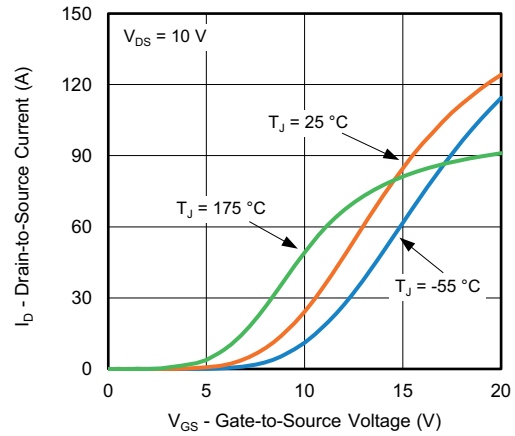

Fig. 4 - Typical Transfer Characteristics

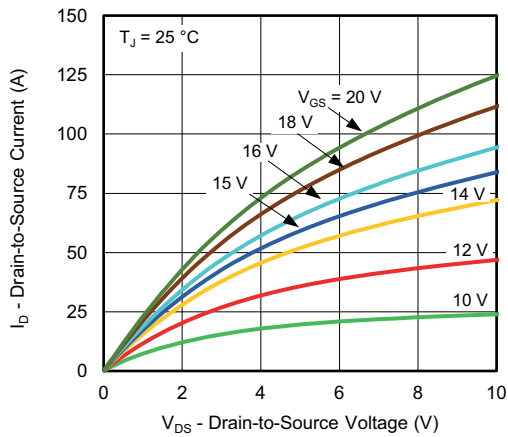

Fig. 2 - Typical Output Characteristics

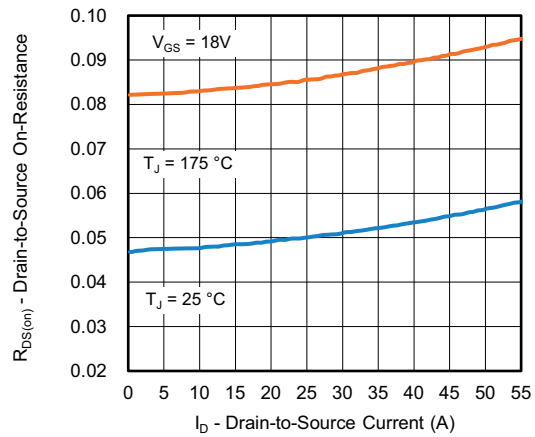

Fig. 5 - Normalized On-Resistance vs. Drain Current

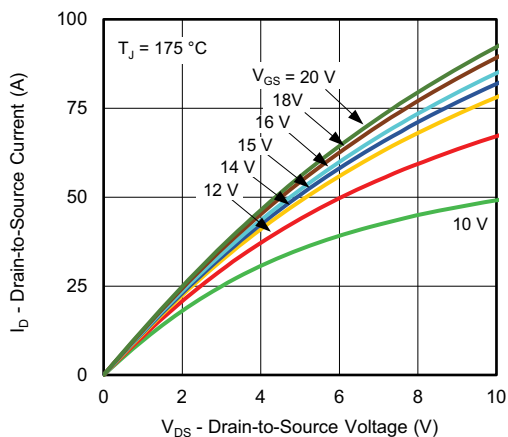

Fig. 3 - Typical Output Characteristics

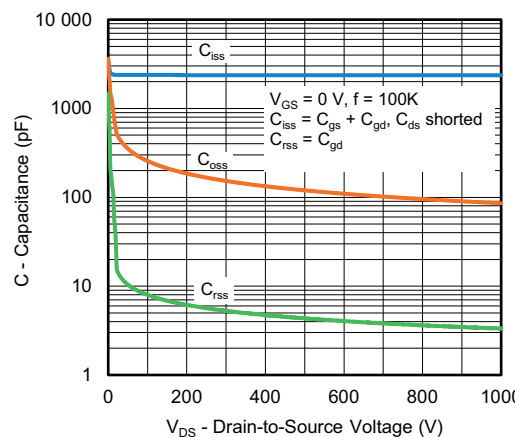

Fig. 6 - Typical Capacitance vs. Drain-to-Source Voltage

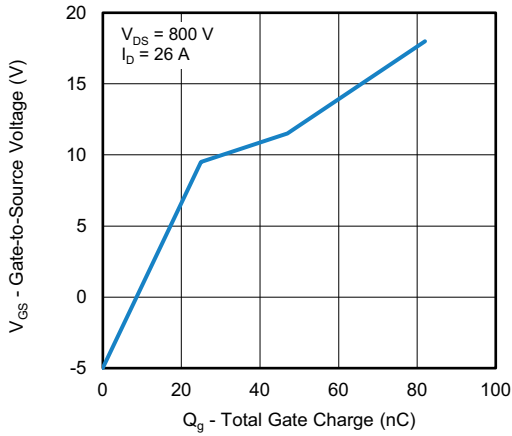

Fig. 7 - Typical Gate Charge vs. Gate-to-Source Voltage

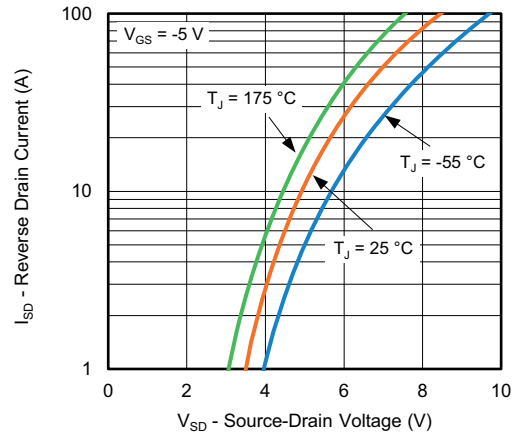

Fig. 10 - Typical Source-Drain Diode Forward Voltage

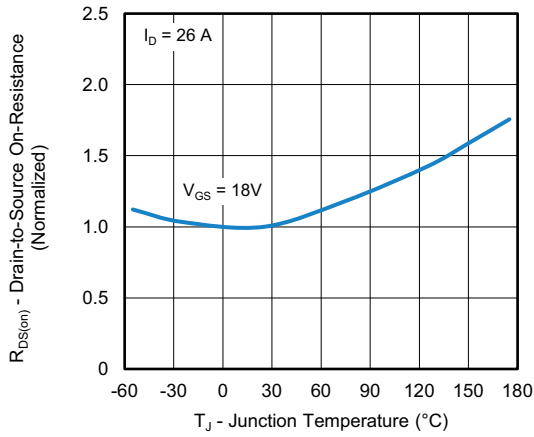

Fig. 8 - Normalized On-Resistance vs. Temperature

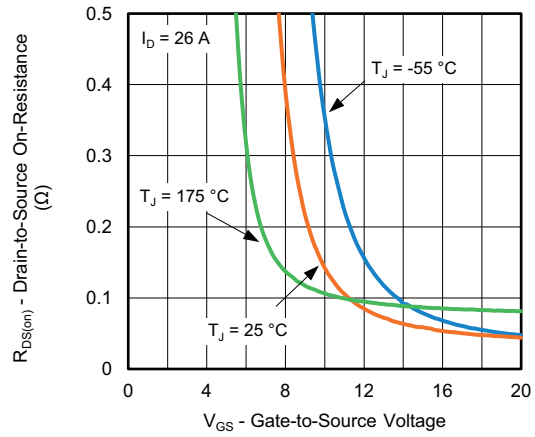

Fig. 11 - On-Resistance vs. Gate-to-Source Voltage

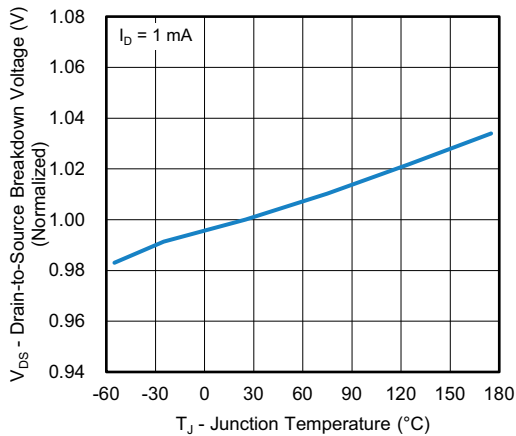

Fig. 9 - Drain-to-Source Voltage vs. Temperature

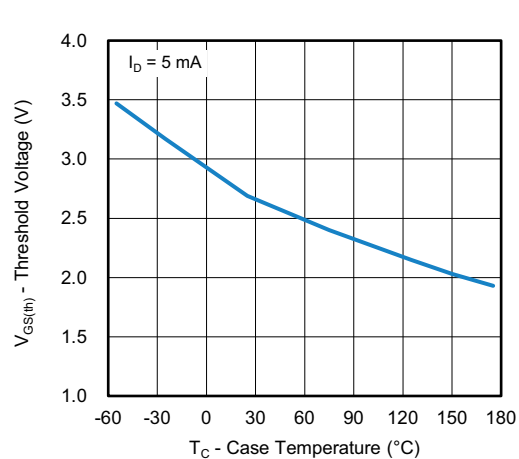

Fig. 12 - Threshold Voltage vs. Case Temperature

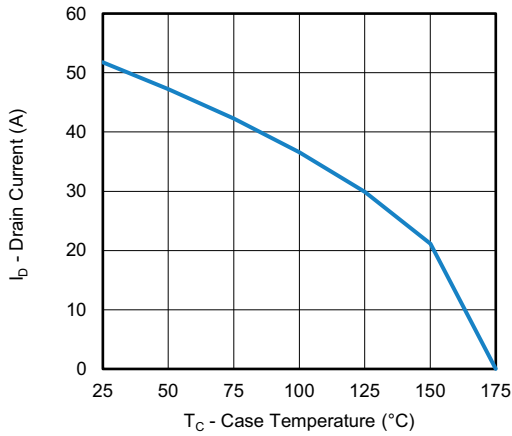

Fig. 13 - Drain Current vs. Case Temperature

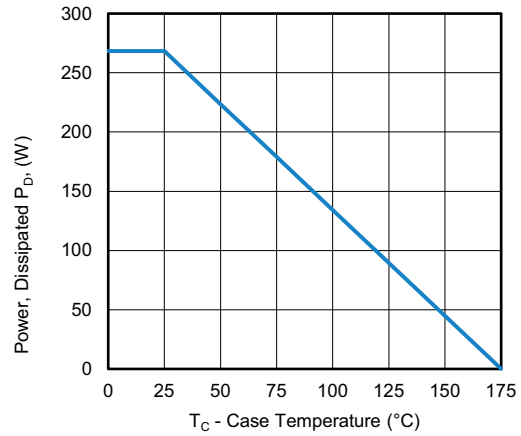

Fig. 15 - Power, Dissipated P_D vs. Case Temperature

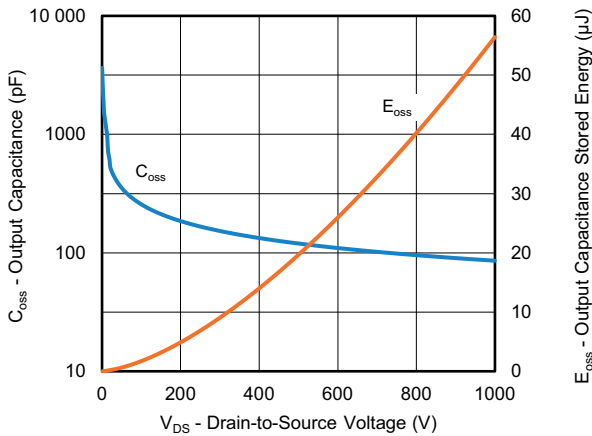

Fig. 14 - Output Capacitance and its Stored Energy vs. Drain-to-Source Voltage

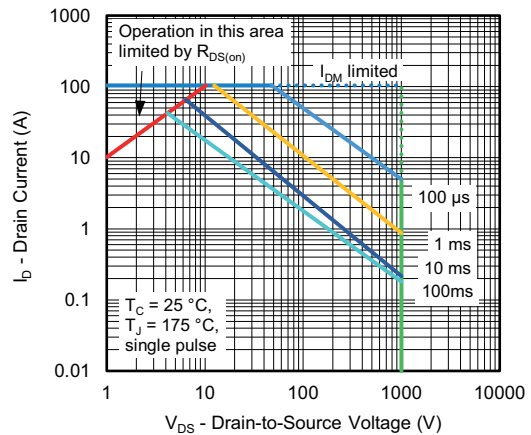

Fig. 16 - Safe Operating Area

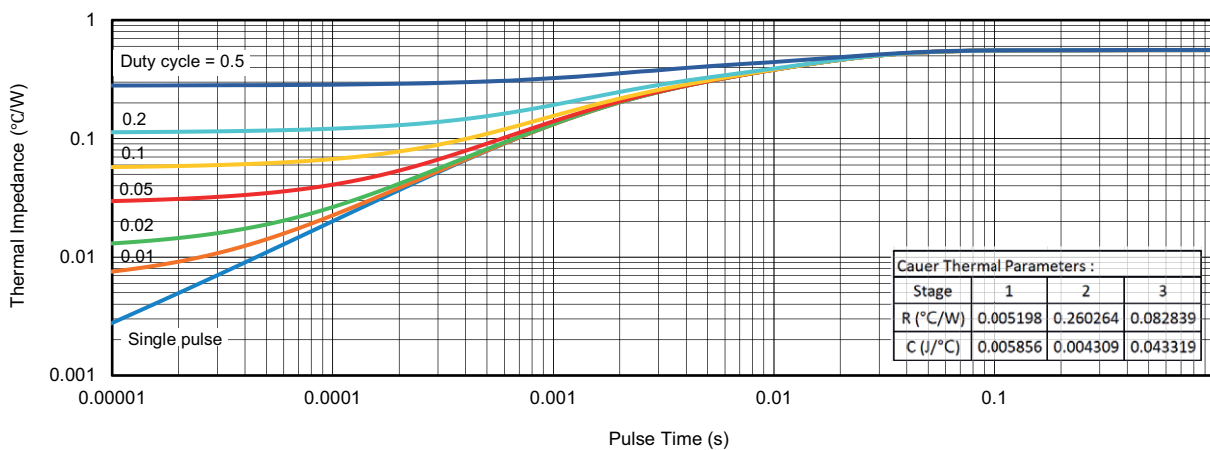

Fig. 17 - Transient Thermal Impedance

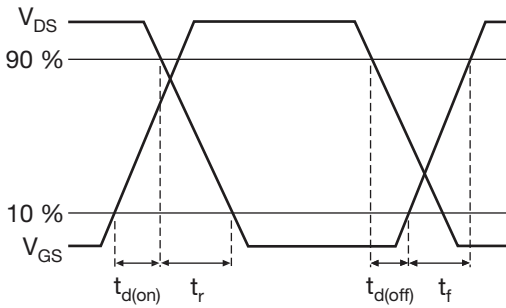

Fig. 18 - Waveforms of Switching Time

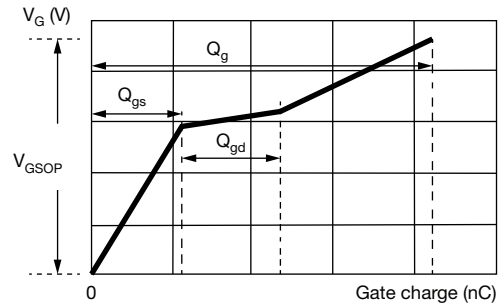

Fig. 21 - Waveforms for Gate Charge

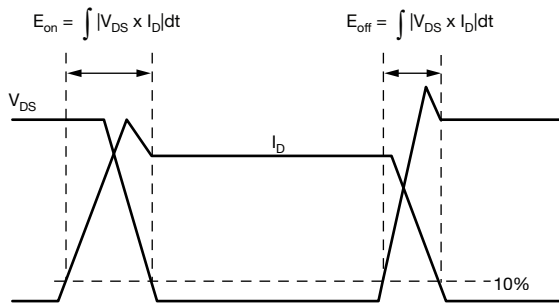

Fig. 19 - Waveforms for Switching Energy

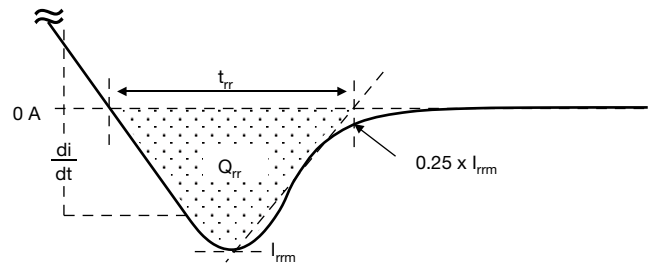

Fig. 22 - Waveforms for Reverse Recovery

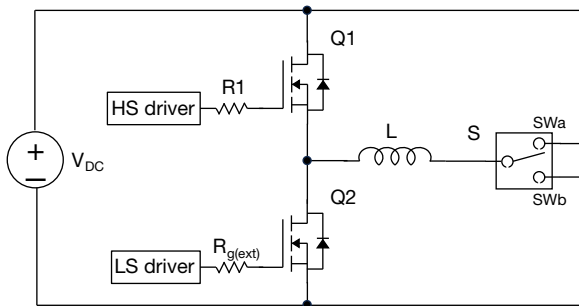

Fig. 20 - Switching and Reverse Diode Characteristics Measurement Circuit

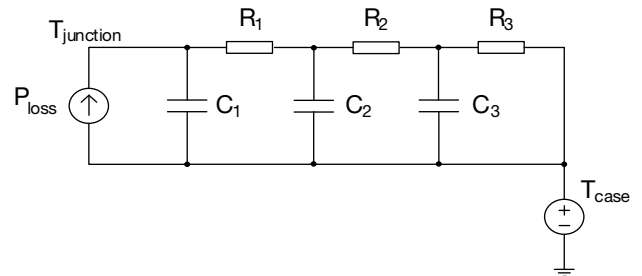
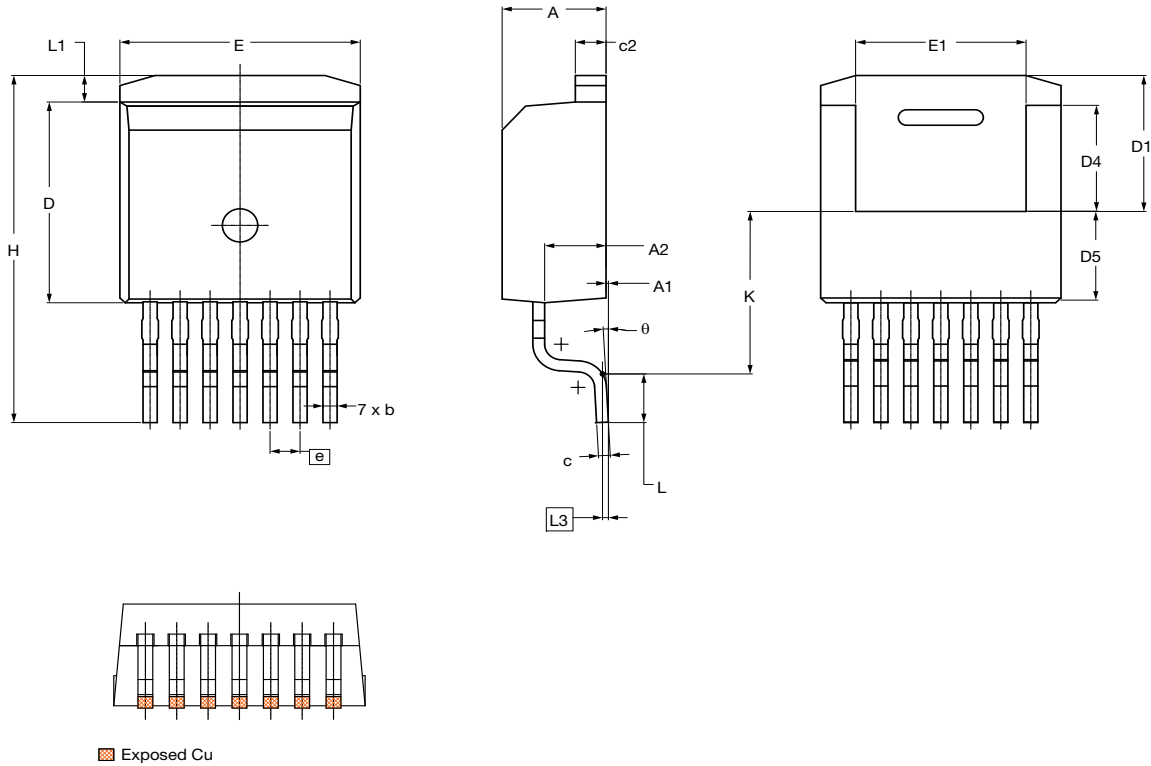

Fig. 23 - Thermal Equivalent Circuit

Vishay Siliconix maintains worldwide manufacturing capability. Products may be manufactured at one of several qualified locations. Reliability data for Silicon Technology and Package Reliability represent a composite of all qualified locations. For related documents such as package / tape drawings, part marking, and reliability data, see www.vishay.com/ppg?92855.

Case Outline for TO-263 7L Package

FACILITY CODE: 9



DIM.	MILLIMETERS		
	MIN.	NOM.	MAX.
A	4.30	4.40	4.50
A1	0.00	0.10	0.25
A2	2.45	2.60	2.75
b	0.50	0.60	0.70
c	0.45	0.50	0.60
c2	1.20	1.30	1.40
D	8.93	9.08	9.23
D1	6.15 ref.		
D4	4.65	4.80	4.95
D5	3.83	4.13	4.43
E	10.08	10.18	10.28
E1	6.82	7.22	7.62
e	1.27 BSC.		
H	15.00	15.70	16.00
K	7.30		
L	1.90	2.20	2.50
L1	1.00	1.20	1.40
L3	0.25 BSC.		
θ	0 °	3 °	7 °

ECN: S25-0851-Rev. C, 18-Jul-2025
DWG: 6119

Notes

- All dimensions are in mm and angles are in degrees
- Dimension D and E do not include mold flash. These dimensions are measured at the outermost extreme of the plastic body
- Thermal pad contour optional within Dimensions E, L1, D4 and E1
- Dimension D4 and E1 establish a minimum mounting surface for the thermal pad
- There is exposed Cu and molding flash bleeding at the pin which is close to package



Disclaimer

ALL PRODUCT, PRODUCT SPECIFICATIONS AND DATA ARE SUBJECT TO CHANGE WITHOUT NOTICE TO IMPROVE RELIABILITY, FUNCTION OR DESIGN OR OTHERWISE.

Vishay Intertechnology, Inc., its affiliates, agents, and employees, and all persons acting on its or their behalf (collectively, "Vishay"), disclaim any and all liability for any errors, inaccuracies or incompleteness contained in any datasheet or in any other disclosure relating to any product.

Vishay makes no warranty, representation or guarantee regarding the suitability of the products for any particular purpose or the continuing production of any product. To the maximum extent permitted by applicable law, Vishay disclaims (i) any and all liability arising out of the application or use of any product, (ii) any and all liability, including without limitation special, consequential or incidental damages, and (iii) any and all implied warranties, including warranties of fitness for particular purpose, non-infringement and merchantability.

Statements regarding the suitability of products for certain types of applications are based on Vishay's knowledge of typical requirements that are often placed on Vishay products in generic applications. Such statements are not binding statements about the suitability of products for a particular application. It is the customer's responsibility to validate that a particular product with the properties described in the product specification is suitable for use in a particular application. Parameters provided in datasheets and / or specifications may vary in different applications and performance may vary over time. All operating parameters, including typical parameters, must be validated for each customer application by the customer's technical experts. Product specifications do not expand or otherwise modify Vishay's terms and conditions of purchase, including but not limited to the warranty expressed therein.

Hyperlinks included in this datasheet may direct users to third-party websites. These links are provided as a convenience and for informational purposes only. Inclusion of these hyperlinks does not constitute an endorsement or an approval by Vishay of any of the products, services or opinions of the corporation, organization or individual associated with the third-party website. Vishay disclaims any and all liability and bears no responsibility for the accuracy, legality or content of the third-party website or for that of subsequent links.

Vishay products are not designed for use in life-saving or life-sustaining applications or any application in which the failure of the Vishay product could result in personal injury or death unless specifically qualified in writing by Vishay. Customers using or selling Vishay products not expressly indicated for use in such applications do so at their own risk. Please contact authorized Vishay personnel to obtain written terms and conditions regarding products designed for such applications.

No license, express or implied, by estoppel or otherwise, to any intellectual property rights is granted by this document or by any conduct of Vishay. Product names and markings noted herein may be trademarks of their respective owners.