

DATA SHEET

SA636

Low voltage high performance mixer FM
IF system with high-speed RSSI

Product data
Supersedes data of 1997 Nov 07

2003 Aug 01

Low voltage high performance mixer FM IF system with high-speed RSSI

SA636

DESCRIPTION

The SA636 is a low-voltage high performance monolithic FM IF system with high-speed RSSI incorporating a mixer/oscillator, two limiting intermediate frequency amplifiers, quadrature detector, logarithmic received signal strength indicator (RSSI), voltage regulator, wideband data output and fast RSSI op amps. The SA636 is available in 20-lead SSOP (shrink small outline package).

The SA636 was designed for high bandwidth portable communication applications and will function down to 2.7 V. The RF section is similar to the famous SA605. The data output has a minimum bandwidth of 600 kHz. This is designed to demodulate wideband data. The RSSI output is amplified. The RSSI output has access to the feedback pin. This enables the designer to adjust the level of the outputs or add filtering.

SA636 incorporates a power-down mode which powers down the device when Pin 8 is LOW. Power down logic levels are CMOS and TTL compatible with high input impedance.

FEATURES

- Wideband data output (600 kHz min.)
- Fast RSSI rise and fall times
- Low power consumption: 6.5 mA typ. at 3 V
- Mixer input to >500 MHz
- Mixer conversion power gain of 11 dB at 240 MHz
- Mixer noise figure of 12 dB at 240 MHz
- XTAL oscillator effective to 150 MHz (L.C. oscillator to 1 GHz local oscillator can be injected)
- 92 dB of IF Amp/Limiter gain
- 25 MHz limiter small signal bandwidth
- Temperature compensated logarithmic Received Signal Strength Indicator (RSSI) with a dynamic range in excess of 90 dB
- RSSI output internal op amp
- Internal op amps with rail-to-rail outputs
- Low external component count; suitable for crystal/ceramic/LC filters
- Excellent sensitivity: 0.54 μ V into 50 Ω matching network for 12 dB SINAD (Signal to Noise and Distortion ratio) for 1 kHz tone with RF at 240 MHz and IF at 10.7 MHz
- ESD hardened
- 10.7 MHz filter matching (330 Ω)
- Power-down mode ($I_{CC} = 200 \mu$ A)

ORDERING INFORMATION

DESCRIPTION	TEMPERATURE RANGE	ORDER CODE	DWG #
20-Pin Plastic Shrink Small Outline Package (Surface-mount)	-40 °C to +85 °C	SA636DK	SOT266-1

PIN CONFIGURATION

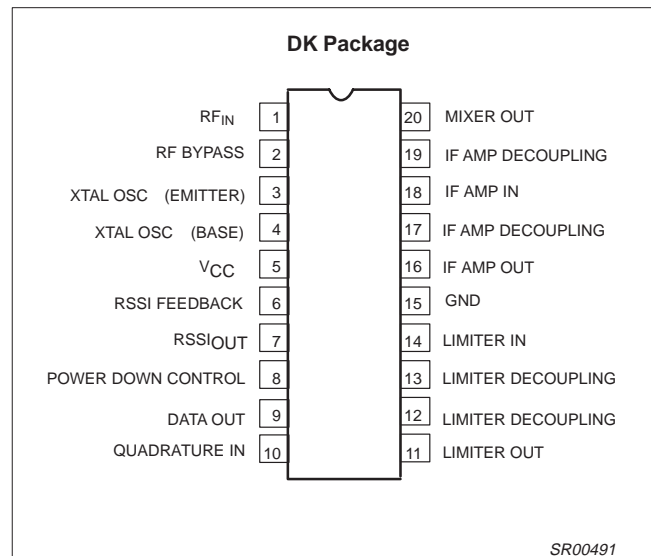

Figure 1. Pin configuration

APPLICATIONS

- DECT (Digital European Cordless Telephone)
- Digital cordless telephones
- Digital cellular telephones
- Portable high performance communications receivers
- Single conversion VHF/UHF receivers
- FSK and ASK data receivers
- Wireless LANs

Low voltage high performance mixer FM IF system with high-speed RSSI

SA636

BLOCK DIAGRAM

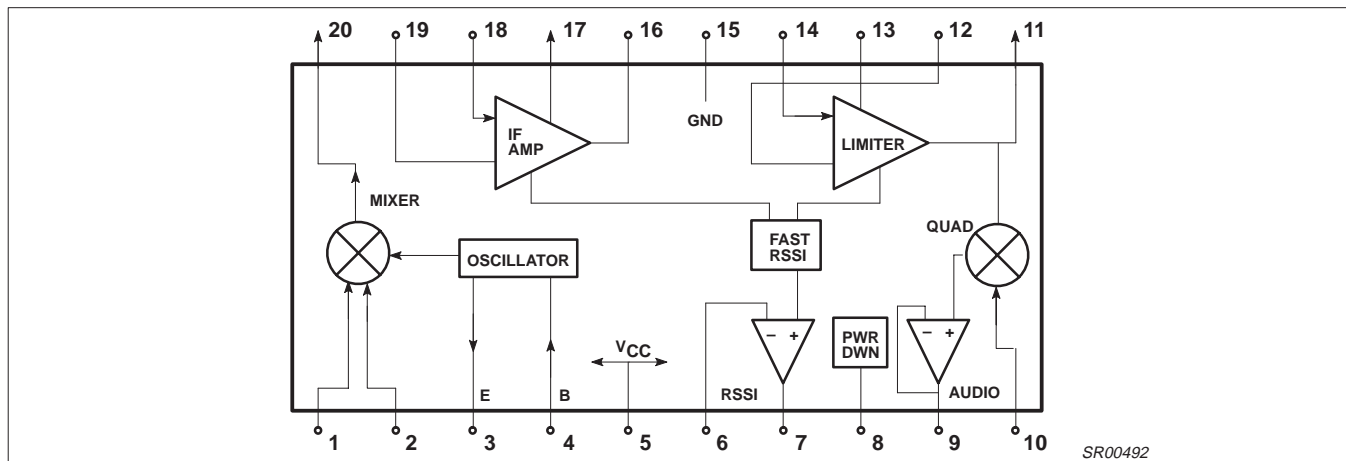

Figure 2. Block diagram

ABSOLUTE MAXIMUM RATINGS

SYMBOL	PARAMETER	RATING	UNITS
V_{CC}	Single supply voltage	0.3 to 7	V
V_{IN}	Voltage applied to any other pin	-0.3 to ($V_{CC}+0.3$)	V
T_{stg}	Storage temperature range	-65 to +150	°C
T_{amb}	Operating ambient temperature range SA636	-40 to +85	°C
θ_{JA}	Thermal impedance (DC package)	117	°C/W

DC ELECTRICAL CHARACTERISTICS

$V_{CC} = +3\text{ V}$, $T_{amb} = 25\text{ °C}$; unless otherwise stated.

SYMBOL	PARAMETER	TEST CONDITIONS	LIMITS			UNITS
			MIN	TYP	MAX	
V_{CC}	Power supply voltage range		2.7	3.0	5.5	V
I_{CC}	DC current drain	Pin 8 = HIGH	5.5	6.5	7.5	mA
	Input current	Pin 8 LOW	-10		10	μA
		Pin 8 HIGH	-10		10	μA
	Input level	Pin 8 LOW	0		$0.3V_{CC}$	V
		Pin 8 HIGH	$0.7V_{CC}$		V_{CC}	V
I_{CC}	Standby	Pin 8 = LOW		0.2	0.5	mA
t_{ON}	Power-up time	RSSI valid (10% to 90%)		10		μs
t_{OFF}	Power-down time	RSSI invalid (90% to 10%)		5		μs

Low voltage high performance mixer FM IF system with high-speed RSSI

SA636

AC ELECTRICAL CHARACTERISTICS

$T_{amb} = 25\text{ }^{\circ}\text{C}$; $V_{CC} = +3\text{V}$, unless otherwise stated. RF frequency = 240.05 MHz + 14.5 dBV RF input step-up; IF frequency = 10.7 MHz; RF level = -45 dBm; FM modulation = 1 kHz with ± 125 kHz peak deviation. Audio output with C-message weighted filter and de-emphasis capacitor. Test circuit Figure 1. The parameters listed below are tested using automatic test equipment to assure consistent electrical characteristics. The limits do not represent the ultimate performance limits of the device. Use of an optimized RF layout will improve many of the listed parameters.

SYMBOL	PARAMETER	TEST CONDITIONS	LIMITS			UNITS
			MIN	TYP	MAX	
Mixer/Osc section (ext LO = 160mV_{RMS})						
f_{IN}	Input signal frequency			500		MHz
f_{OSC}	External oscillator (buffer)			500		MHz
	Noise figure at 240 MHz			12		dB
	Third-order input intercept point	Matched $f_1=240.05$ MHz; $f_2=240.35$ MHz		-16		dBm
	Conversion power gain	Matched 14.5 dBV step-up	8	11	14	dB
	RF input resistance	Single-ended input		700		Ω
	RF input capacitance			3.5		pF
	Mixer output resistance	(Pin 20)		330		Ω
IF section						
	IF amp gain	330 Ω load		38		dB
	Limiter gain	330 Ω load		54		dB
	Input limiting -3dB	Test at Pin 18		-105		dBm
	AM rejection	80% AM 1 kHz		50		dB
	Data level	$R_{LOAD} = 100$ k Ω	120	130		mV _{RMS}
	3 dB data bandwidth		600	700		kHz
	SINAD sensitivity	RF level = -111 dBm		16		dB
THD	Total harmonic distortion			-43	-38	dB
S/N	Signal-to-noise ratio	No modulation for noise		60		dB
	IF RSSI output with buffer	IF level = -118 dBm		0.2	0.5	V
		IF level = -68 dBm	0.3	0.6	1.0	V
		IF level = -10 dBm	0.9	1.3	1.8	V
	IF RSSI output rise time (10kHz pulse, no 10.7MHz filter) (no RSSI bypass capacitor)	IF frequency = 10.7 MHz RF level = -56 dBm		1.2		μ s
		RF level = -28 dBm		1.1		μ s
	IF RSSI output fall time (10 kHz pulse, no 10.7 MHz filter) (no RSSI bypass capacitor)	IF frequency = 10.7 MHz RF level = -56 dBm		2.0		μ s
		RF level = -28 dBm		7.3		μ s
	RSSI range			90		dB
	RSSI accuracy			± 1.5		dB
	IF input impedance			330		Ω
	IF output impedance			330		Ω
	Limiter input impedance			330		Ω
	Limiter output impedance			300		Ω
	Limiter output level with no load			130		mV _{RMS}
RF/IF section (int LO)						
	System RSSI output	RF level = -10 dBm		1.4		V
	System SINAD	RF level = -106 dBm		12		dB

Low voltage high performance mixer FM IF system with high-speed RSSI

SA636

PERFORMANCE CHARACTERISTICS

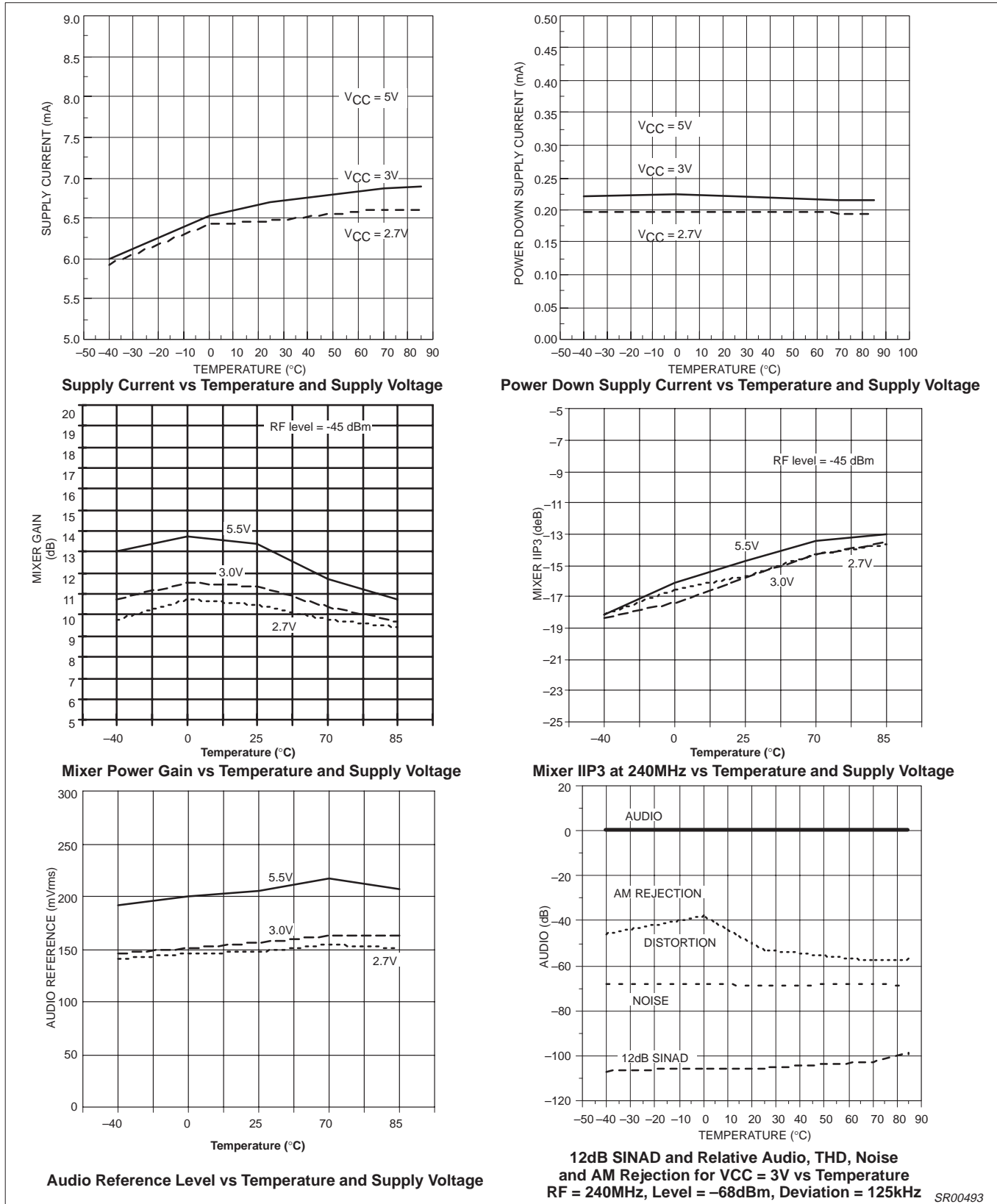

SR00493

Figure 3. Performance Characteristics

Low voltage high performance mixer FM IF system with high-speed RSSI

SA636

PERFORMANCE CHARACTERISTICS (continued)

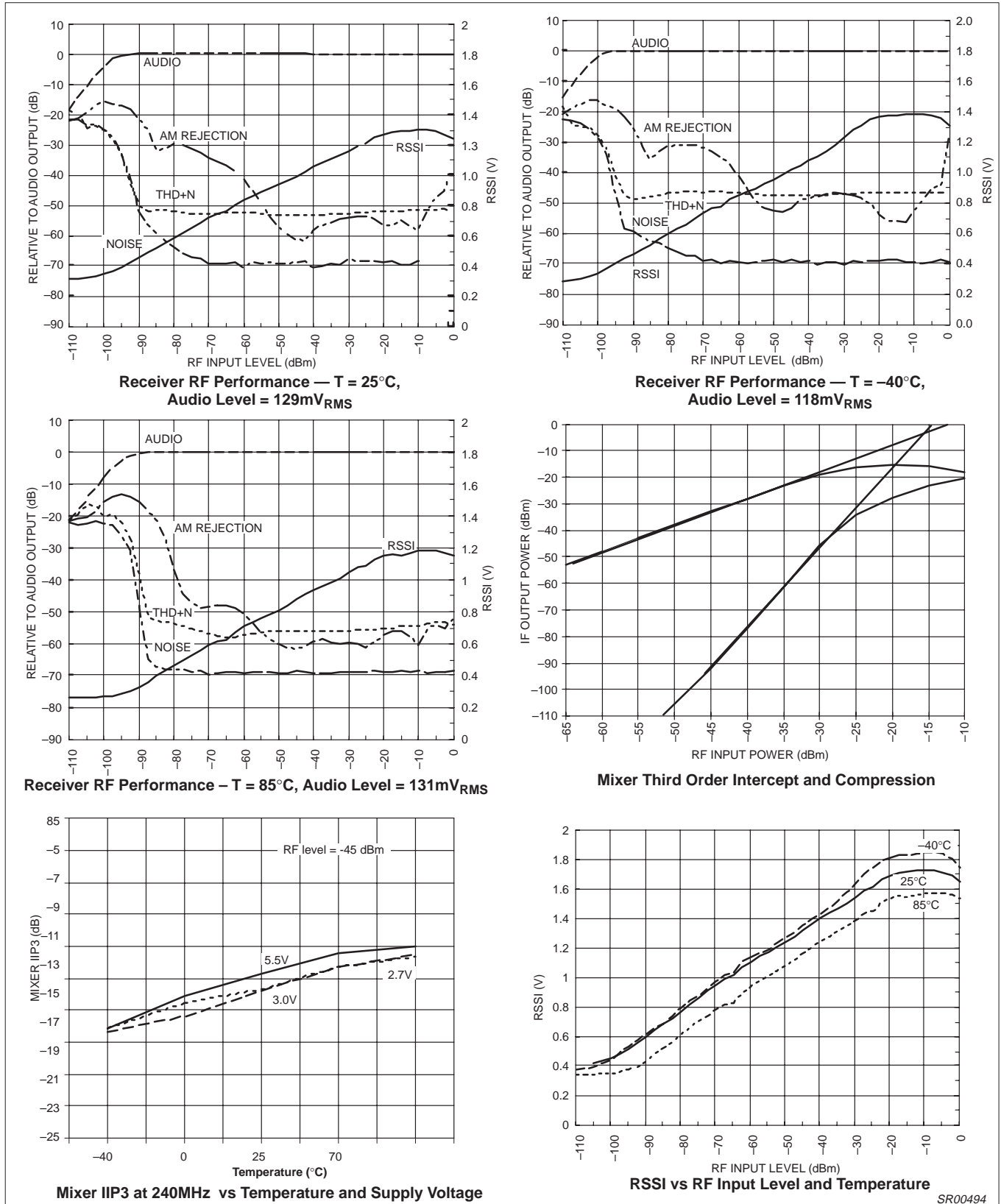

SR00494

Figure 4. Performance Characteristics

Low voltage high performance mixer FM IF system with high-speed RSSI

SA636

PERFORMANCE CHARACTERISTICS (continued)

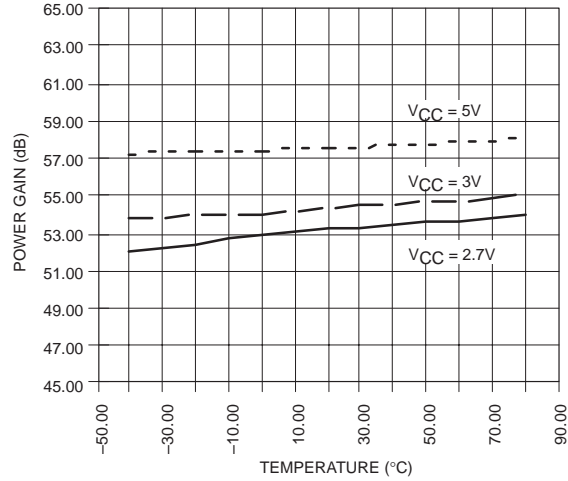
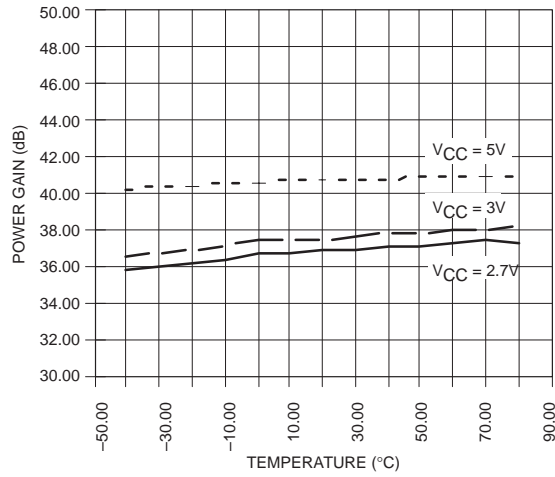

SA626 IF Amplifier Gain vs Temperature vs Supply Voltage

SA626 Limiting Amplifier Gain vs Temperature vs Supply Voltage

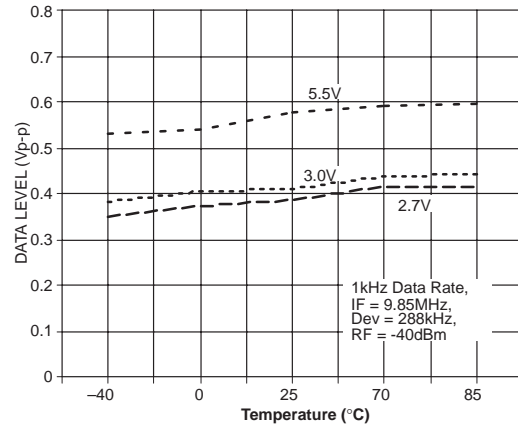
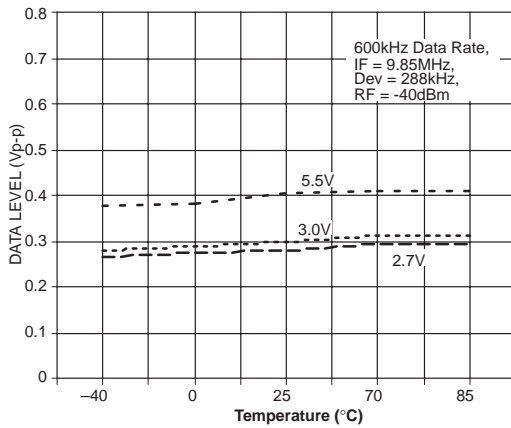

Data Level vs Temperature and Supply Voltage

Data Level vs Temperature and Supply Voltage

SR00495

Figure 5. Performance Characteristics

Low voltage high performance mixer FM IF system with high-speed RSSI

SA636

PERFORMANCE CHARACTERISTICS (continued)

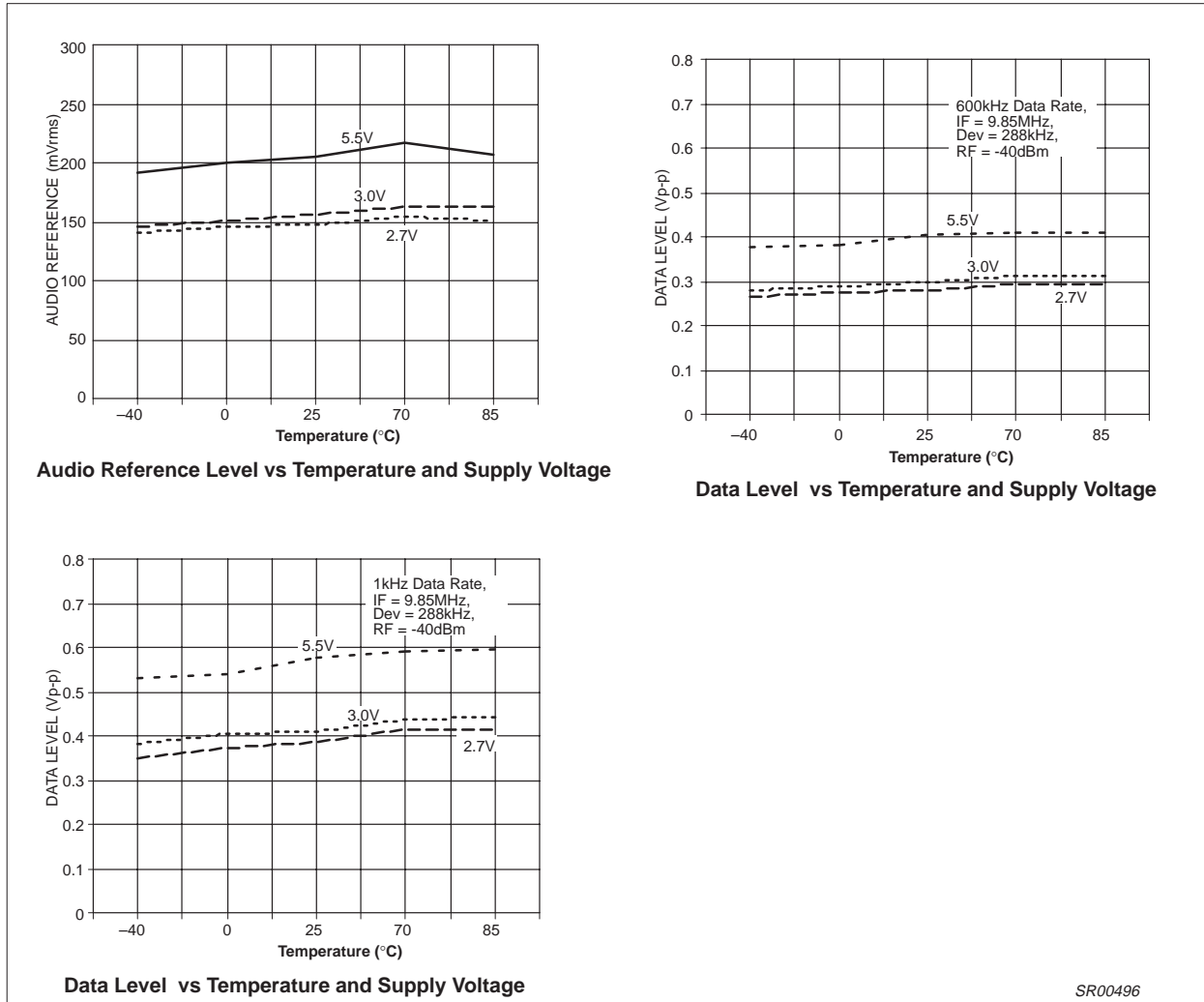

Figure 6. Performance Characteristics

SR00496

Low voltage high performance mixer FM IF system with high-speed RSSI

SA636

PIN FUNCTIONS

PIN No.	PIN MNEMONIC	DC V	EQUIVALENT CIRCUIT	PIN No.	PIN MNEMONIC	DC V	EQUIVALENT CIRCUIT
1	RF IN	+1.07		6	RSSI FEEDBACK	+0.20	
2	RF BYPASS	+1.07		7	RSSI OUT	+0.20	
3	XTAL OSC	+1.57		8	POWER DOWN	+2.75	
4	XTAL OSC	+2.32		9	DATA OUT	+1.09	
5	V _{CC}	+3.00		10	QUAD. IN	+3.00	

SR00497

Figure 7. Pin Functions

Low voltage high performance mixer FM IF system with high-speed RSSI

SA636

PIN FUNCTIONS (continued)

PIN No.	PIN MNEMONIC	DC V	EQUIVALENT CIRCUIT	PIN No.	PIN MNEMONIC	DC V	EQUIVALENT CIRCUIT
11	LIMITER OUT	+1.35		16	IF AMP OUT	+1.22	
12	LIMITER DECOUP	+1.23		17	IF AMP DECOUP	+1.22	
13	LIMITER COUPLING	+1.23		18	IF AMP IN	+1.22	
14	LIMITER IN	+1.23		19	IF AMP DECOUP	+1.22	
15	GND	0		20	MIXER OUT	+1.03	

SR00498

Figure 8. Pin Functions (cont.)

Low voltage high performance mixer FM IF system with high-speed RSSI

SA636

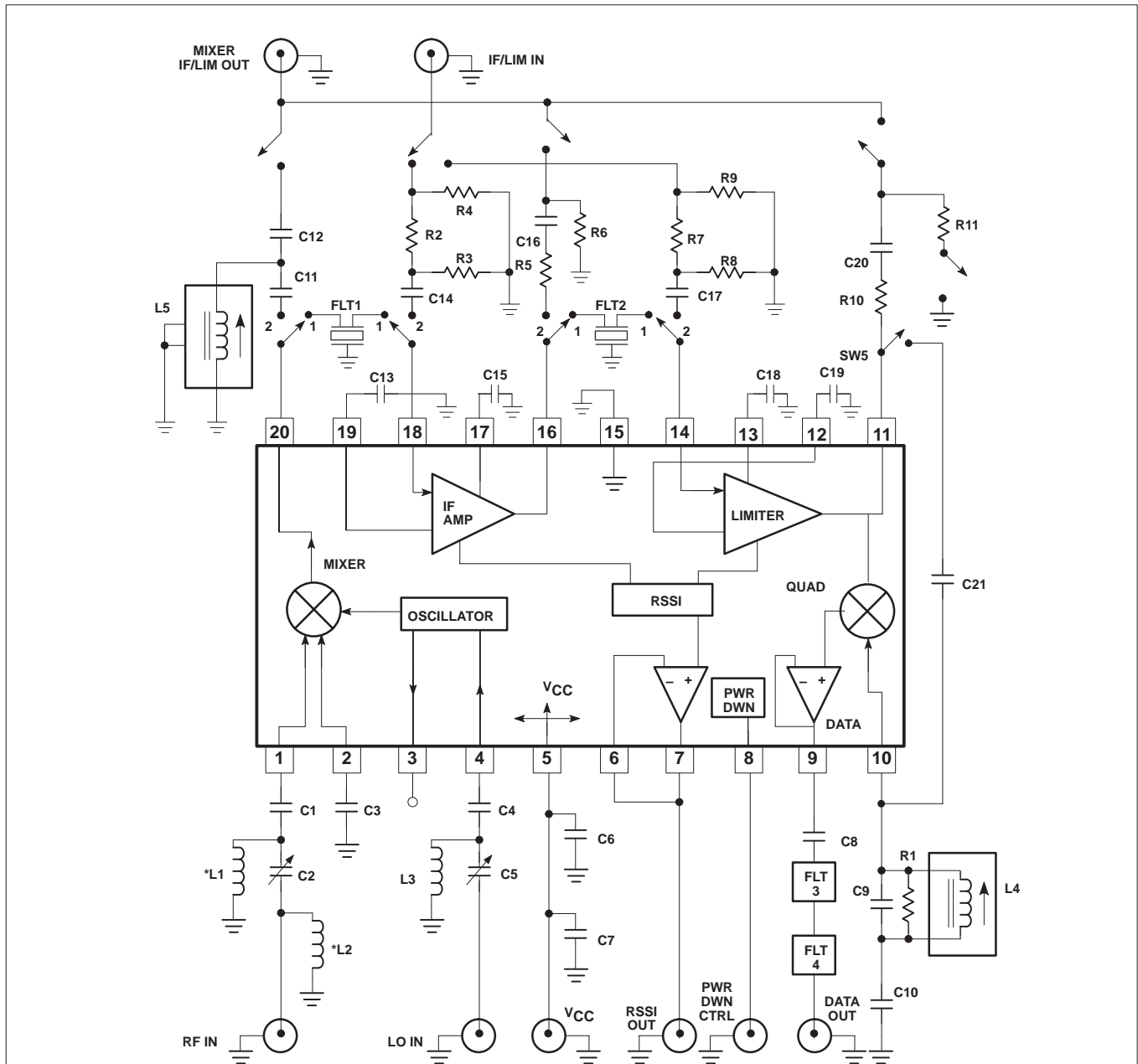

Automatic Test Circuit Component List

R1 8.2kΩ select	C1 0.1μF	C12 160pF select	L1 150nH select for input match
R2 6.42kΩ	C2 1–5pF select for input match	C13 1000pF	L2 22nH select for input match
R3 347.8Ω	C3 0.1μF	C14 0.1μF	L3 47nH select for input match
R4 49.9Ω	C4 0.1μF	C15 1000pF	L4 5.6μH select for input match
R5 1kΩ	C5 1–5pF select for input match	C16 0.1μF	L5 1.27–2.25μH select for mixer output match
R6 49.9Ω	C6 100pF	C17 0.1μF	
R7 6.42kΩ	*C7 6.8μF 10V	C18 1000pF	FLT1 10.7MHz (Murata SFE10.7MA5-A)
R8 347.8Ω	C8 1μF	C19 1000pF	FLT2 10.7MHz (Murata SFE10.7MA5-A)
R9 49.9Ω	C9 39pF select	C20 0.1μF	FLT3 “C” message weighted
R10 1kΩ	C10 0.1μF	C21 1pF	FLT4 Active de-emphasis
R11 49.9Ω	C11 0.1μF		

*NOTE: This value can be reduced when a battery is the power source.

SR00501

Figure 9. SA636 240.05MHz (RF) / 10.7MHz (IF) Test Circuit

Low voltage high performance mixer FM IF system with high-speed RSSI

SA636

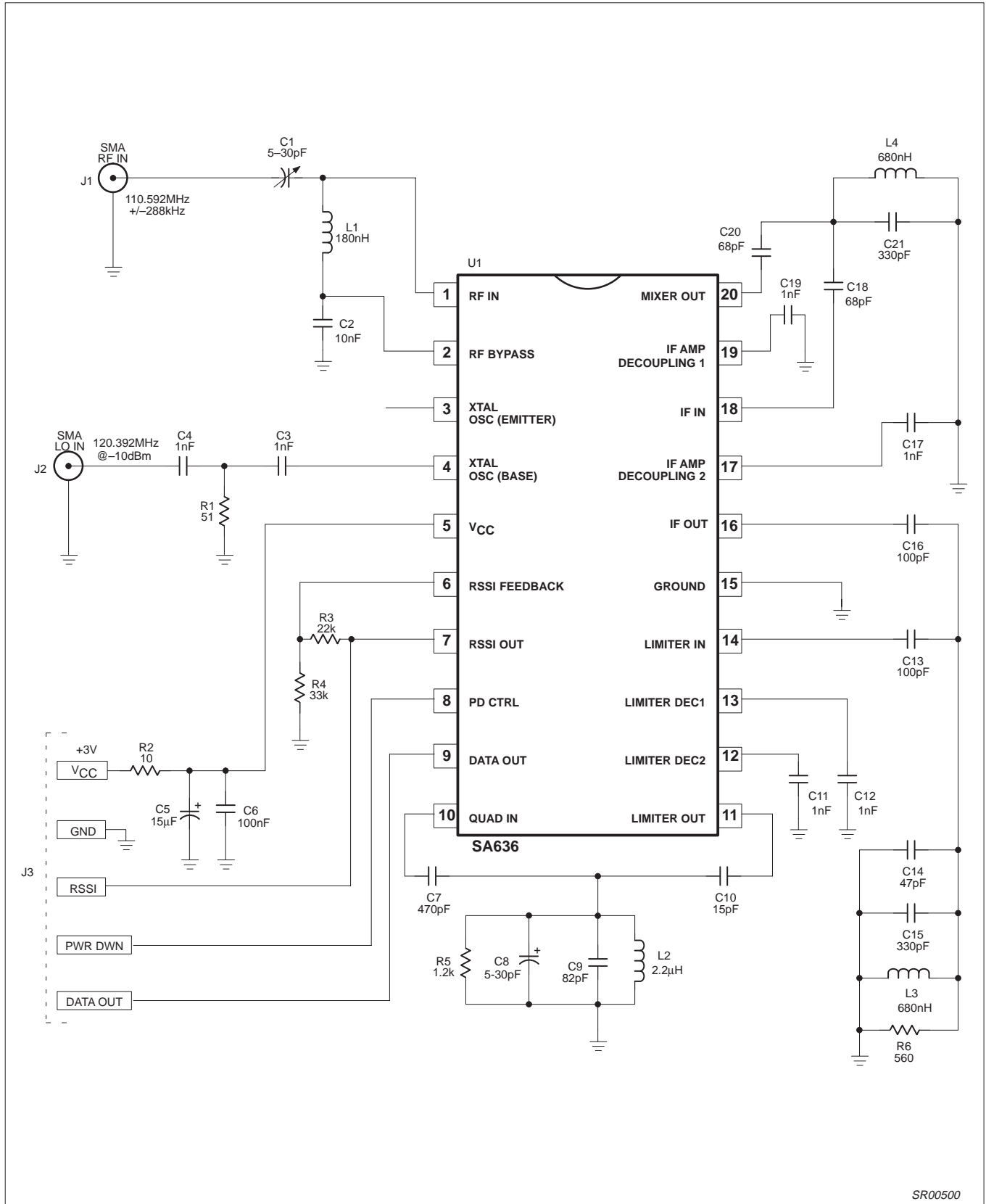

Figure 10. SA636 110.592 MHz (RF) / 9.8 MHz (IF) DECT Application Circuit

SR00500

Low voltage high performance mixer FM IF system with high-speed RSSI

SA636

Table 1. DECT Application Circuit Electrical Characteristics

RF frequency = 110.592 MHz; IF frequency = 9.8 MHz; RF level = -45 dBm; FM modulation = 100 kHz with ±288 kHz peak deviation.

SYMBOL	PARAMETER	TEST CONDITIONS	TYPICAL	UNITS
Mixer/Osc section (ext LO = 160 mV_{RMS})				
PG	Conversion power gain		13	dB
NF	Noise Figure at 110 MHz		12	dB
IIP3	Third order input intercept	Matched f1 = 110.592 MHz; f2 = 110.892 MHz	-15	dBm
R _{IN}	RF input resistance		690	Ω
C _{IN}	RF input capacitance		3.6	pF
IF section				
	IF amp gain	330 Ω load	38	dB
	Limiter amp gain	330 Ω load	54	dB
	Data level	R _{LOAD} = 3 kΩ	130	mV _{RMS}
	3 dB data bandwidth		700	kHz
RF/IF section (internal LO)				
	System RSSI output	RF level = -10 dBm	1.4	V
	System S/N ¹	RF level = -83 dBm	10	dB

NOTE:

1. 10 dB S/N corresponds to BER = 10⁻³.

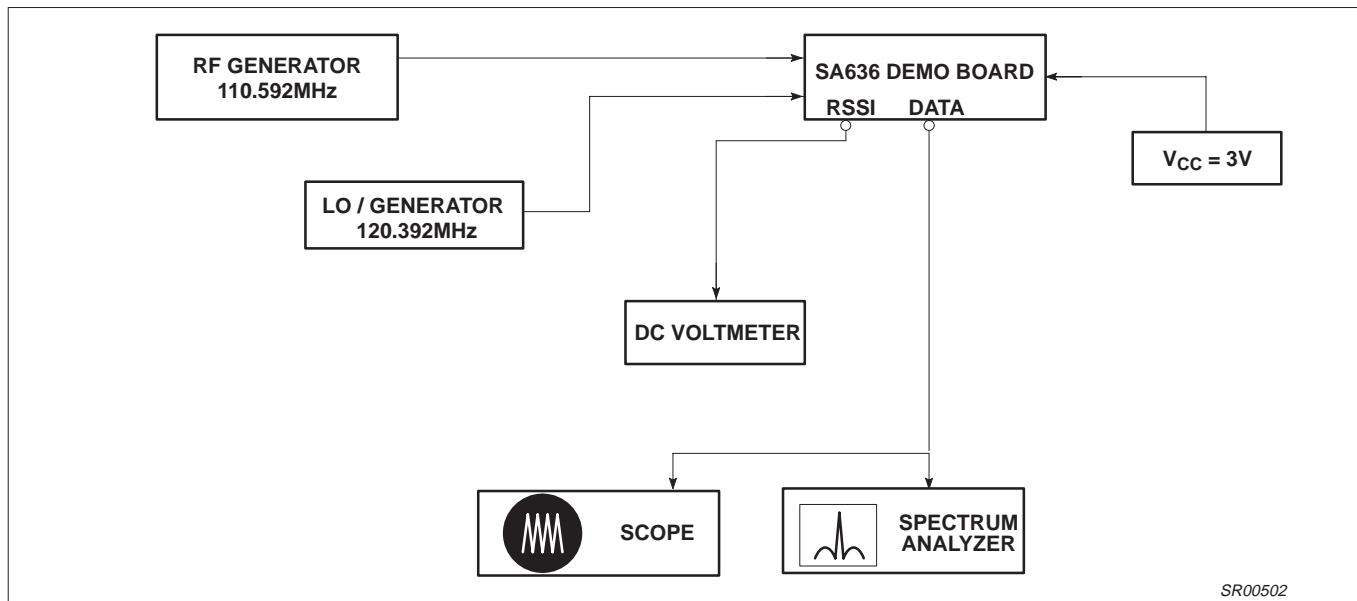

Figure 11. SA636 Application Circuit Test Set Up

NOTES:

1. RF generator: Set your RF generator at 110.592 MHz, use a 100 kHz modulation frequency and a ±288 kHz deviation.
2. Layout: The layout is very critical in the performance of the receiver. We highly recommend our demo board layout.
3. RSSI: The smallest RSSI voltage (i.e., when no RF input is present and the input is terminated) is a measure of the quality of the layout and design. If the lowest RSSI voltage is 500 mV or higher, it means the receiver is in regenerative mode. In that case, the receiver sensitivity will be worse than expected.
4. Supply bypass and shielding: All of the inductors, the quad tank, and their shield must be grounded. A 0.1 μF bypass capacitor on the supply pin improves sensitivity.

Low voltage high performance mixer FM IF system with high-speed RSSI

SA636

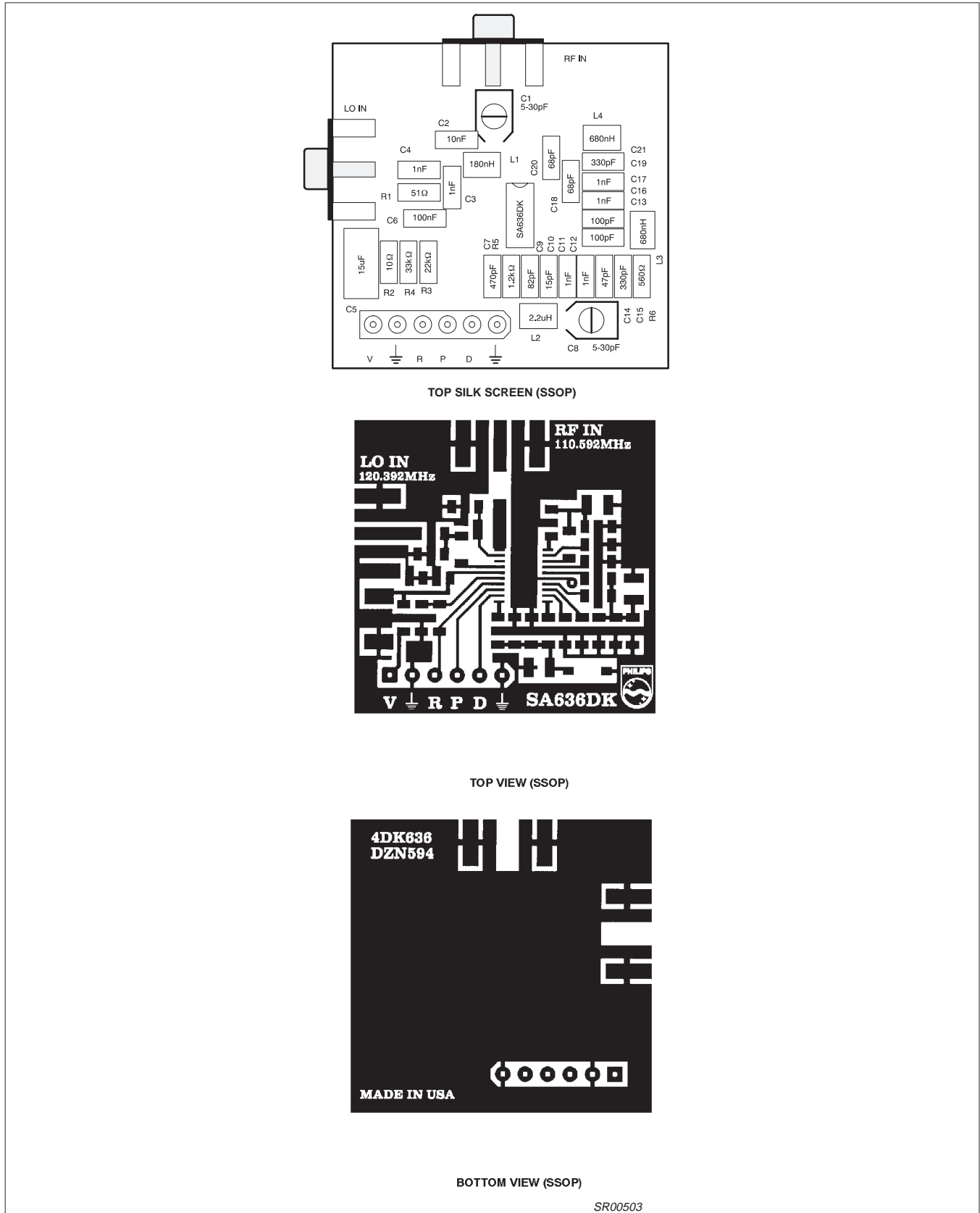

Figure 12. SA636 Demoboard Layout (Not Actual Size)

SR00503

Low voltage high performance mixer FM IF system with high-speed RSSI

SA636

CIRCUIT DESCRIPTION

The SA636 is an IF signal processing system suitable for second IF or single conversion systems with input frequency as high as 1 GHz. The bandwidth of the IF amplifier is about 40 MHz, with 38 dB of gain from a 50 Ω source. The bandwidth of the limiter is about 28 MHz with about 54 dB of gain from a 50 Ω source. However, the gain/bandwidth distribution is optimized for 10.7 MHz, 330 Ω source applications. The overall system is well-suited to battery operation as well as high performance and high quality products of all types, such as cordless and cellular hand-held phones.

The input stage is a Gilbert cell mixer with oscillator. Typical mixer characteristics include a noise figure of 14 dB, conversion gain of 11 dB, and input third-order intercept of -16 dBm. The oscillator will operate in excess of 1 GHz in L/C tank configurations. Hartley or Colpitts circuits can be used up to 100 MHz for xtal configurations. Butler oscillators are recommended for xtal configurations up to 150 MHz.

The output of the mixer is internally loaded with a 330 Ω resistor permitting direct connection to a 10.7 MHz ceramic filter for narrowband applications. The input resistance of the limiting IF amplifiers is also 330 Ω . With most 10.7 MHz ceramic filters and many crystal filters, no impedance matching network is necessary. For applications requiring wideband IF filtering, such as DECT, external LC filters are used (see Figure 10). To achieve optimum linearity of the log signal strength indicator, there must be a 6 dB(v) insertion loss between the first and second IF stages. If the IF filter

or interstage network does not cause 6 dB(v) insertion loss, a fixed or variable resistor can be added between the first IF output (Pin 16) and the interstage network.

The signal from the second limiting amplifier goes to a Gilbert cell quadrature detector. One port of the Gilbert cell is internally driven by the IF. The other output of the IF is AC-coupled to a tuned quadrature network. This signal, which now has a 90° phase relationship to the internal signal, drives the other port of the multiplier cell.

Overall, the IF section has a gain of 90 dB. For operation at intermediate frequency at 10.7 MHz. Special care must be given to layout, termination, and interstage loss to avoid instability.

The demodulated output (DATA) of the quadrature is a voltage output. This output is designed to handle a minimum bandwidth of 600 kHz. This is designed to demodulate wideband data, such as in DECT applications.

A Receive Signal Strength Indicator (RSSI) completes the circuitry. The output range is greater than 90 dB and is temperature compensated. This log signal strength indicator exceeds the criteria for AMPS or TACS cellular telephone, DECT and RCR-28 cordless telephone. This signal drives an internal op amp. The op amp is capable of rail-to-rail output. It can be used for gain, filtering, or 2nd-order temperature compensation of the RSSI, if needed.

NOTE: $\text{dB(v)} = 20 \log V_{\text{OUT}}/V_{\text{IN}}$

Low voltage high performance mixer FM
IF system with high-speed RSSI

SA636

SSOP20: plastic shrink small outline package; 20 leads; body width 4.4 mm

SOT266-1

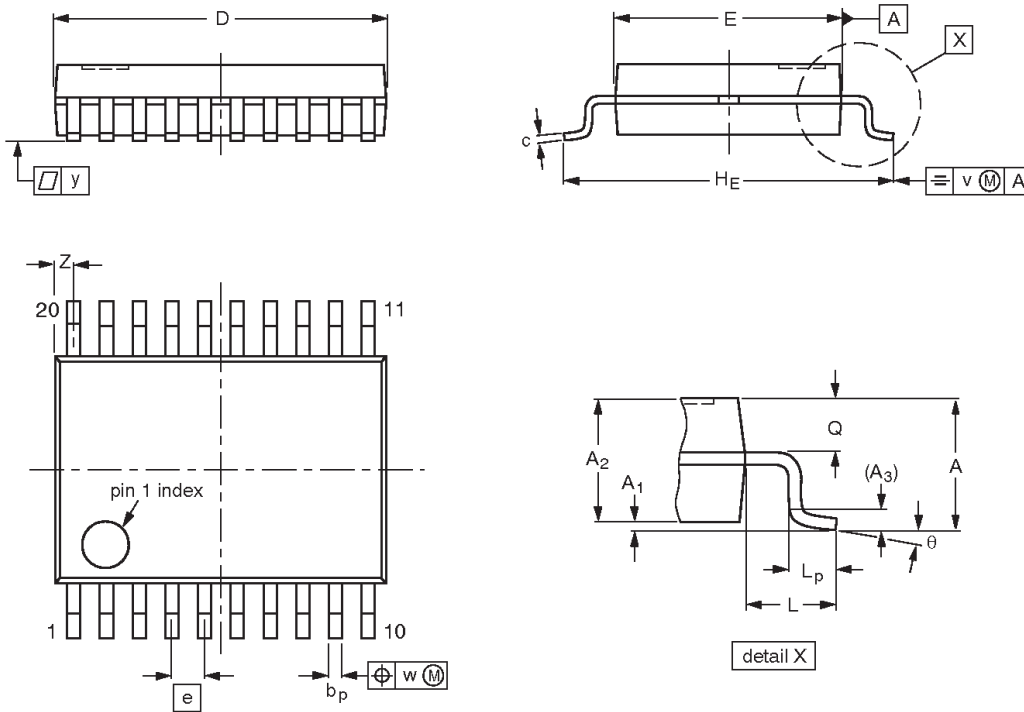

DIMENSIONS (mm are the original dimensions)

UNIT	A max.	A ₁	A ₂	A ₃	b _p	c	D ⁽¹⁾	E ⁽¹⁾	e	HE	L	L _p	Q	v	w	y	Z ⁽¹⁾	θ
mm	1.5	0.15 0	1.4 1.2	0.25	0.32 0.20	0.20 0.13	6.6 6.4	4.5 4.3	0.65	6.6 6.2	1	0.75 0.45	0.65 0.45	0.2	0.13	0.1	0.48 0.18	10° 0°

Note

1. Plastic or metal protrusions of 0.20 mm maximum per side are not included.

OUTLINE VERSION	REFERENCES				EUROPEAN PROJECTION	ISSUE DATE
	IEC	JEDEC	JEITA			
SOT266-1		MO-152				99-12-27 03-02-19

Low voltage high performance mixer FM IF system with high-speed RSSI

SA636

REVISION HISTORY

Rev	Date	Description
_2	20030801	Product data (9397 750 11848). ECN 853-1757 30101 of 15 July 2003. Supersedes data of 1997 Nov 07. Modifications: <ul style="list-style-type: none"> ● Change package outline drawing to SOT266-1.
_1	19971107	Product data. ECN 853-1757 18664 of 07 November 1997. Replaces data of 1994 Jun 16

Data sheet status

Level	Data sheet status ^[1]	Product status ^[2] [3]	Definitions
I	Objective data	Development	This data sheet contains data from the objective specification for product development. Philips Semiconductors reserves the right to change the specification in any manner without notice.
II	Preliminary data	Qualification	This data sheet contains data from the preliminary specification. Supplementary data will be published at a later date. Philips Semiconductors reserves the right to change the specification without notice, in order to improve the design and supply the best possible product.
III	Product data	Production	This data sheet contains data from the product specification. Philips Semiconductors reserves the right to make changes at any time in order to improve the design, manufacturing and supply. Relevant changes will be communicated via a Customer Product/Process Change Notification (CPCN).

[1] Please consult the most recently issued data sheet before initiating or completing a design.

[2] The product status of the device(s) described in this data sheet may have changed since this data sheet was published. The latest information is available on the Internet at URL <http://www.semiconductors.philips.com>.

[3] For data sheets describing multiple type numbers, the highest-level product status determines the data sheet status.

Definitions

Short-form specification — The data in a short-form specification is extracted from a full data sheet with the same type number and title. For detailed information see the relevant data sheet or data handbook.

Limiting values definition — Limiting values given are in accordance with the Absolute Maximum Rating System (IEC 60134). Stress above one or more of the limiting values may cause permanent damage to the device. These are stress ratings only and operation of the device at these or at any other conditions above those given in the Characteristics sections of the specification is not implied. Exposure to limiting values for extended periods may affect device reliability.

Application information — Applications that are described herein for any of these products are for illustrative purposes only. Philips Semiconductors make no representation or warranty that such applications will be suitable for the specified use without further testing or modification.

Disclaimers

Life support — These products are not designed for use in life support appliances, devices, or systems where malfunction of these products can reasonably be expected to result in personal injury. Philips Semiconductors customers using or selling these products for use in such applications do so at their own risk and agree to fully indemnify Philips Semiconductors for any damages resulting from such application.

Right to make changes — Philips Semiconductors reserves the right to make changes in the products—including circuits, standard cells, and/or software—described or contained herein in order to improve design and/or performance. When the product is in full production (status 'Production'), relevant changes will be communicated via a Customer Product/Process Change Notification (CPCN). Philips Semiconductors assumes no responsibility or liability for the use of any of these products, conveys no license or title under any patent, copyright, or mask work right to these products, and makes no representations or warranties that these products are free from patent, copyright, or mask work right infringement, unless otherwise specified.

Contact information

For additional information please visit
<http://www.semiconductors.philips.com>. Fax: +31 40 27 24825

© Koninklijke Philips Electronics N.V. 2003
 All rights reserved. Printed in U.S.A.

Date of release: 08-03

For sales offices addresses send e-mail to:
sales.addresses@www.semiconductors.philips.com

Document order number:

9397 750 11848

Let's make things better.