



DC load monitoring relay for PROFINET, max. 1x63 A DC, max. 800 V Width: 45.0 mm Monitoring for violation of upper and lower limit of current, voltage and power; Energy consumption counter, energy recovery counter, switching cycle counter, operating hours counter, warning and alarm thresholds, automatic or manual reset, ON delay 0-999.0 sec, OFF delay 0-999.0 sec, automatic reclosing delay 0-999.0 sec Supply voltage: 24 V DC 1 changeover contact, screw terminal

Figure similar

Product brand name	SIRIUS
Design of the product	for PROFINET
Product type designation	3UG5
General technical data	
Type of current for monitoring	DC
Power loss [W] maximum	3 W
Insulation voltage	
<ul style="list-style-type: none"> • for overvoltage category III according to IEC 60664 with degree of pollution 3 rated value 	300 V
<ul style="list-style-type: none"> • of the auxiliary and control current circuit for overvoltage category III according to IEC 60664 with degree of pollution 3 rated value 	30 V
Type of voltage for monitoring	DC
Surge voltage resistance rated value	8 kV
maximum permissible voltage for safe isolation	
<ul style="list-style-type: none"> • between auxiliary and auxiliary circuit 	24 V
<ul style="list-style-type: none"> • between control and auxiliary circuit 	24 V
Protection class IP	

<ul style="list-style-type: none"> • on the front • of the terminal 	IP20 IP00
Shock resistance acc. to IEC 60068-2-27	sinusoidal half-wave 15g / 11 ms
Vibration resistance acc. to IEC 60068-2-6	1 ... 6 Hz: 15 mm, 6 ... 500 Hz: 2g
Mechanical service life (switching cycles) typical	10 000 000
Electrical endurance (switching cycles) for relay outputs maximum	100 000
Thermal current of the switching element with contacts maximum	1 A
Certificate of suitability	CE
Reference code acc. to DIN EN 81346-2	K

Product Function

Product function	
<ul style="list-style-type: none"> • Overvoltage detection DC • undervoltage detection DC • Overcurrent detection DC • undercurrent detection DC • Auto-reset • Manual RESET 	Yes Yes Yes Yes Yes Yes

Supply voltage

Type of voltage of the supply voltage	DC
Supply voltage 1 at DC rated value	24 V
Operating range factor supply voltage rated value at DC	0.85 ... 1.15

Measuring circuit

Measurable current	-63 ... +63 A
Measurable voltage at DC	0 ... 800 V
Adjustable voltage range	0 ... 800 V
Adjustable pick-up value current	
<ul style="list-style-type: none"> • 1 	-63 ... +63 A
Adjustable response delay time	
<ul style="list-style-type: none"> • when starting • with lower or upper limit violation 	0 ... 999 s 0 ... 999 s
Response time maximum	100 ms
Relative temperature-related measurement deviation	0.5 %
Internal resistance of the measuring circuit	10 mΩ

Communication/ Protocol

Protocol is supported	
<ul style="list-style-type: none"> • PROFINET IO protocol • Address Resolution Protocol (ARP) 	Yes Yes
Design of the interface Fast Ethernet interface	Yes

Number of interfaces acc. to PROFINET	1
Product function at the Ethernet interface Autocrossover	Yes
Interface design 1 RJ45 (Ethernet)	Yes
Product function at the 1st interface PROFINET IO device	Yes
Number of ports at the 1st interface	1
Service for open IE communication LLDP	Yes
Transmission mode for Industrial Ethernet	PROFINET with 100 Mbps full duplex (100BASE-TX)
PROFINET conformity class	A
Network load class acc. to PROFINET	1

Auxiliary circuit

Number of CO contacts for auxiliary contacts	1
--	---

Outputs

Ampacity of the output relay at DC-13	
<ul style="list-style-type: none"> at 24 V 	1 A
Ampacity for overcurrent duration < 1 s maximum permissible	1 A
Continuous current of the DIAZED fuse link of the output relay	2 A

Electromagnetic compatibility

Conducted interference	
<ul style="list-style-type: none"> due to burst acc. to IEC 61000-4-4 	2 kV
<ul style="list-style-type: none"> due to conductor-earth surge acc. to IEC 61000-4-5 	2 kV
<ul style="list-style-type: none"> due to conductor-conductor surge acc. to IEC 61000-4-5 	1 kV
Field-bound parasitic coupling acc. to IEC 61000-4-3	10 V/m
Electrostatic discharge acc. to IEC 61000-4-2	6 kV contact discharge / 8 kV air discharge

Galvanic isolation

Design of the electrical isolation	Protective separation
Galvanic isolation	
<ul style="list-style-type: none"> between entrance and outlet 	Yes
<ul style="list-style-type: none"> between the voltage supply and other circuits 	Yes

Safety related data

Electromagnetic compatibility	IEC 60947-1 / IEC 61000-6-2 / IEC 61000-6-4
--------------------------------------	---

Connections/ Terminals

Product function	
<ul style="list-style-type: none"> removable terminal for main circuit 	No
<ul style="list-style-type: none"> removable terminal for auxiliary and control circuit 	Yes

Type of electrical connection	screw-type terminals
Type of connectable conductor cross-sections	
<ul style="list-style-type: none"> • for main contacts <ul style="list-style-type: none"> — solid — stranded — finely stranded with core end processing • at AWG conductors for main contacts 	<p>2x (1 ... 16 mm²), 1x (1 ... 16 mm²)</p> <p>2x (1 ... 16 mm²), 1x (1 ... 16 mm²)</p> <p>2x (1 ... 25 mm²), 1x (1 ... 35 mm²)</p> <p>1x (18 ... 1), 2x (18 ... 2)</p>
Type of connectable conductor cross-sections	
<ul style="list-style-type: none"> • for auxiliary contacts <ul style="list-style-type: none"> — solid — finely stranded with core end processing • at AWG conductors for auxiliary contacts 	<p>1x (0.5 ... 4 mm²), 2x (0.5 ... 2.5 mm²)</p> <p>2x (0,5 ... 1,5 mm²), 1x (0,5 ... 4 mm²)</p> <p>1x (20 ... 12), 2x (20 ... 14)</p>
Tightening torque	
<ul style="list-style-type: none"> • for main contacts with screw-type terminals • for auxiliary contacts with screw-type terminals 	<p>3 ... 4.5 N·m</p> <p>0.6 ... 0.8 N·m</p>



Installation/ mounting/ dimensions

Mounting position	any
Mounting type	screw and snap-on mounting onto 35 mm standard mounting rail
Height	100 mm
Width	45 mm
Depth	141.6 mm
Required spacing	
<ul style="list-style-type: none"> • with side-by-side mounting <ul style="list-style-type: none"> — forwards — Backwards — upwards — downwards — at the side • for grounded parts <ul style="list-style-type: none"> — forwards — Backwards — upwards — at the side — downwards • for live parts <ul style="list-style-type: none"> — forwards — Backwards — upwards — downwards — at the side 	<p>0 mm</p> <p>0 mm</p> <p>50 mm</p> <p>50 mm</p> <p>0 mm</p> <p>0 mm</p> <p>0 mm</p> <p>50 mm</p> <p>3 mm</p> <p>50 mm</p> <p>0 mm</p> <p>0 mm</p> <p>50 mm</p> <p>50 mm</p> <p>3 mm</p>

Ambient conditions

Installation altitude at height above sea level maximum	2 000 m
Ambient temperature	
• during operation	-25 ... +60 °C
• during storage	-40 ... +80 °C
• during transport	-40 ... +80 °C

Certificates/ approvals

General Product Approval	Declaration of Conformity	Test Certificates	other
 UL		 EG-Konf.	Type Test Certificates/Test Report Declaration of Conformity Confirmation

other



Profibus

Further information

Information- and Downloadcenter (Catalogs, Brochures,...)

www.siemens.com/sirius/catalogs

Industry Mall (Online ordering system)

<https://mall.industry.siemens.com/mall/en/en/Catalog/product?mlfb=3UG5462-1AA40>

Cax online generator

<http://support.automation.siemens.com/WW/CAXorder/default.aspx?lang=en&mlfb=3UG5462-1AA40>

Service&Support (Manuals, Certificates, Characteristics, FAQs,...)

<https://support.industry.siemens.com/cs/ww/en/ps/3UG5462-1AA40>

Image database (product images, 2D dimension drawings, 3D models, device circuit diagrams, EPLAN macros, ...)

http://www.automation.siemens.com/bilddb/cax_de.aspx?mlfb=3UG5462-1AA40&lang=en

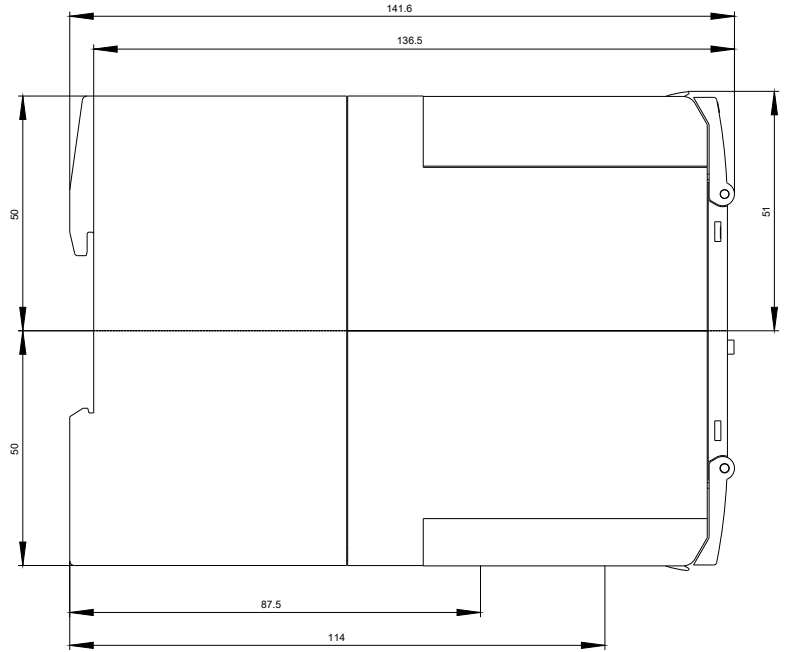
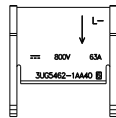
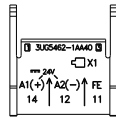
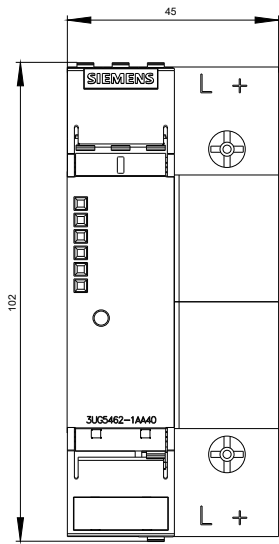

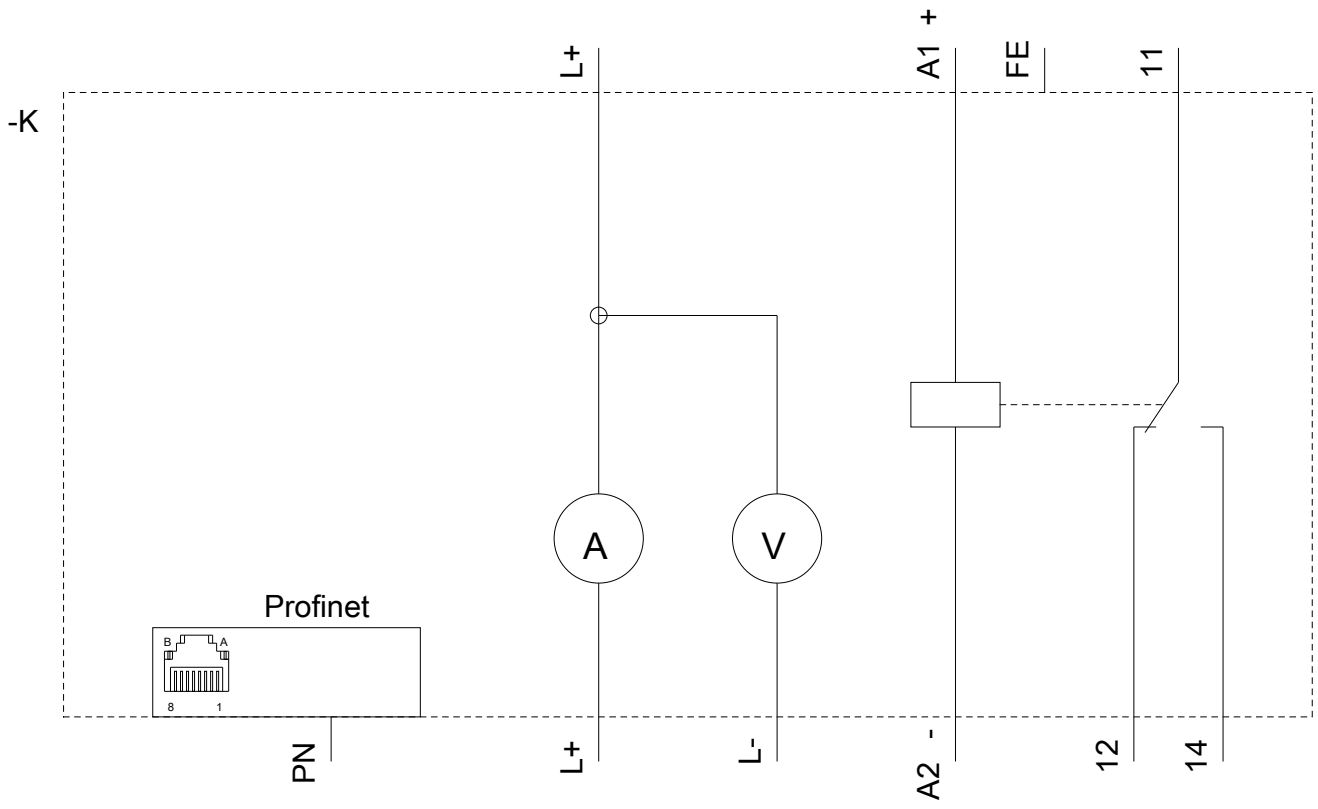

last modified:

11/28/2019