

## Ultra Precision Shunt Resistor (40 Watts)

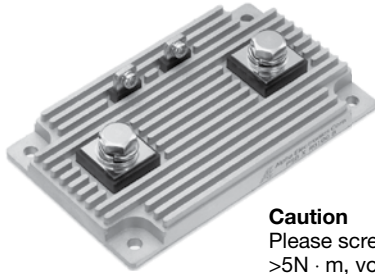

PSB

**Caution**  
Please screw current terminals  
>5N · m, voltage terminal >1N · m

### COMPOSITION OF TYPE NUMBER

Example:

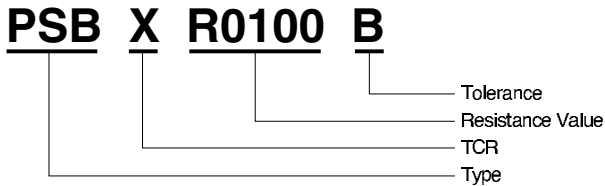

Resistance value in ohm is expressed by a series of four significant digits and an R designating the decimal point.

### CONFIGURATION (DIMENSIONS IN mm)

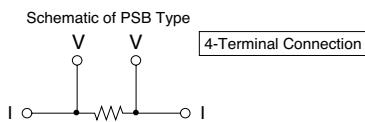
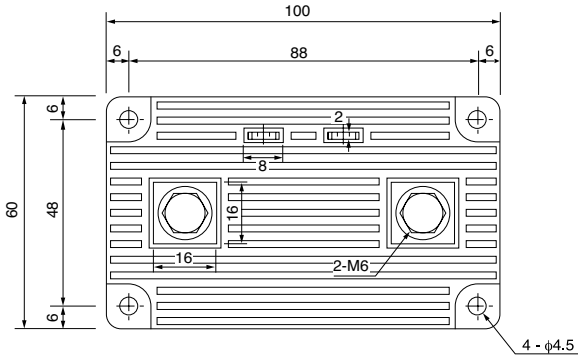

Weight =170g

### FEATURES

- Excellent temperature characteristics created by Bulk Metal® foil technology
- Accurate value on four-terminal wiring, even in low extremity of resistance
- High heat dissipation due to aluminum-clad construction with fins
- Readiness to mount to heat sink or water-cooled radiator
- Availability of threaded holes to fix cables with screw

### APPLICATIONS

- Current-sensing in precise power supply, motor driver, etc.

### TCR, RESISTANCE RANGE, TOLERANCE, RATED POWER

TCR (ppm/°C) 0°C to +60°C	Resistance Range (Ω)	Resistance Tolerance (%)	Rated Power (W) at 25°C
0±15 (W)	0.001 to 0.005	±0.1 (B) ±0.5 (D) ±1 (F)	12 in free air and 40 On heat sink*
0±5 (X) 0±15 (W)	0.005 to 1		

\*Thermal resistance of the heat sink 1°C/W.

Available to use higher rated power with elevation of cooling effect.  
Please keep temperature of element surface less than 60°C.

### POWER DERATING CURVE

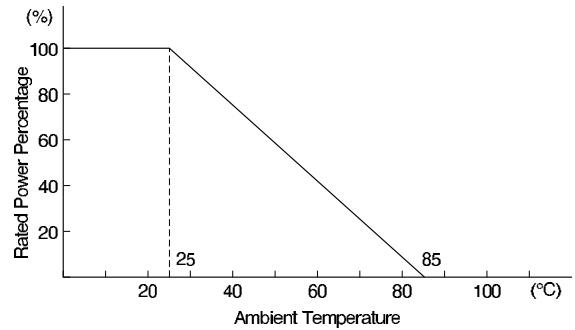

### EXAMPLE OF APPLICATIONS

#### Motor Control Circuit Using Shunt Resistor

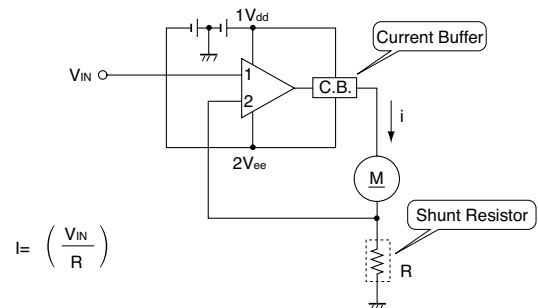

<b>PERFORMANCE</b>			
Parameters	Test Condition	ALPHA Specification	ALPHA Typical Test Data
Maximum Rated Operating Temperature Working Temperature Range Maximum Working Current			25°C -55°C to +85°C 100A
Power Conditioning	25°C, Rated Power, 96 hrs.	±0.1%	±0.05%
Low Temperature Storage and Operation	-55°C, No Load, 24 hrs.	±0.1%	±0.05%
Dielectric Withstanding Voltage Insulation Resistance Low Temperature Operation Overload	Atmo. Pres.: AC 750V, 1 min. DC 500V, 2 min. -55°C, Rated Power Rated Power x 2.5, 5 sec.	±0.05% over 10,000 MΩ ±0.1% ±0.1%	±0.01% over 10,000 MΩ ±0.05% ±0.05%
Moisture Resistance	+65°C to -10°C, 90% RH to 98% RH, Rated Voltage, 10 cycles (240 hrs.)	±0.1%	±0.05%
Shock High Frequency Shock	30G, 11 ms., Half-Sine Wave, X, Y, Z, 10 shocks each 10 Hz to 50 Hz to 10 Hz, 1 min. X, Y, Z, 2.0 hrs. each	±0.05% ±0.05%	±0.1% ±0.1%
Life	25°C, Rated Power, 1.5 hrs. – ON, 0.5 hrs. – OFF, 2,000 hrs.	±0.2%	±0.05%
High Temperature Exposure	85°C, No Load, 2,000 hrs.	±0.2%	±0.05%
Storage Life	15°C to 35°C, 15% RH to 75% RH, No Load, 10,000 hrs.	±0.05%	±0.01%
Internal Thermal Resistance	Between resistive element and base plate		0.3°C/W
Thermal Electromotive Force			1 μV/°C

**FREQUENCY CHARACTERISTICS**

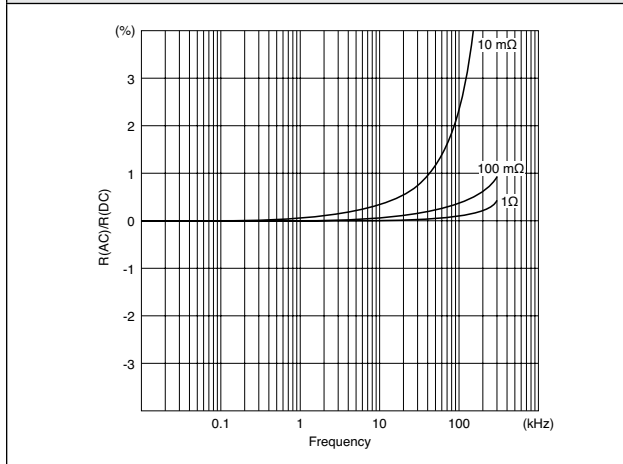

**TEMPERATURE OF RESISTOR SURFACE**

