

KEMET Part Number: HHBC12-1R0A0028V
(UALC121R0A0028)

KEMET, HHBC, AC Line Filters, Normal Mode, 28 uH, 20%

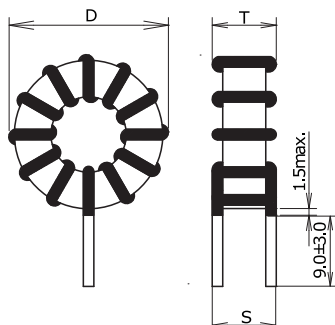

Dimensions	
D	26mm MAX
T	12.1mm MAX
LL	9mm +/-3mm
S	9mm NOM

Packaging Specifications	
Packaging:	Tray
Packaging Quantity:	240
Weight:	13 g

General Information	
Series:	HHBC
Style:	Through-Hole
Features:	Noise Solution, Switching Power Supply Outlets, DC-DC Converter
RoHS:	Yes
Miscellaneous:	25 (K) Temperature Rise Max.

Specifications	
Inductance:	28 uH
Inductance Tolerance:	20%
Current:	5 A
Temperature Range:	-40/+125°C
DC Resistance:	21.1 mOhms