

# FPF2116 IntelliMAX™ Advanced Load Management Products

## Features

- 1.8 to 5.5V Input Voltage Range
- Controlled Turn-On
- 200mA Current Limit
- Undervoltage Lockout
- Thermal Shutdown
- <math>2\mu\text{A}</math> Shutdown Current
- Auto Restart
- Fast Current limit Response Time
  - 3 $\mu\text{s}$  to Moderate Over Currents
  - 20ns to Hard Shorts
- Fault Blanking
- Reverse Current Blocking
- RoHS Compliant

## Applications

- PDAs
- Cell Phones
- GPS Devices
- MP3 Players
- Digital Cameras
- Peripheral Ports
- Hot Swap Supplies



## General Description

The FPF2116 is a load switch which provides full protection to systems and loads which may encounter large current conditions. This device contains a 0.125 $\Omega$  current-limited P-channel MOSFET which can operate over an input voltage range of 1.8-5.5V. Internally, current is prevented from flowing when the MOSFET is off and the output voltage is higher than the input voltage. Switch control is by a logic input (ON) capable of interfacing directly with low voltage control signals. The part contains thermal shutdown protection which shuts off the switch to prevent damage to the part when a continuous over-current condition causes excessive heating.

When the switch current reaches the current limit, the part operates in a constant-current mode to prohibit excessive currents from causing damage. If the constant current condition still persists after 30ms, the part will shut off the switch and pull the fault signal pin (FLAGB) low. An auto-restart feature will turn the switch on again after 480ms if the ON pin is still active. The minimum current limit is 200mA.

The part is available in a space-saving 5 pin SOT23 package.

## Typical Application Circuit

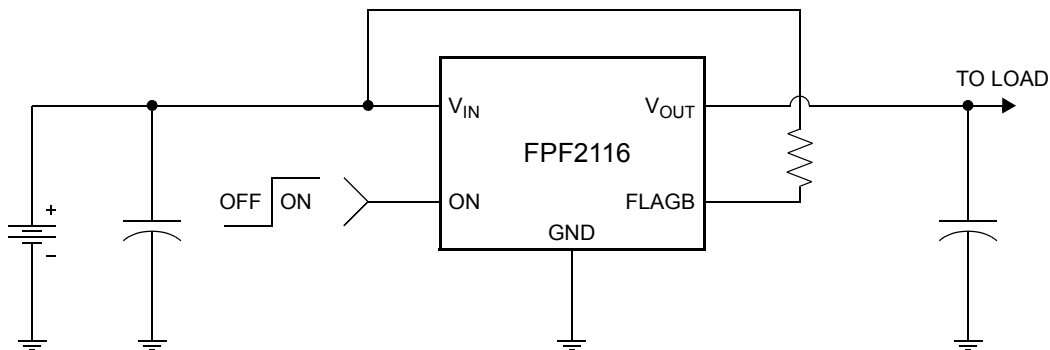

## Ordering Information

Part	Current Limit [mA]	Current Limit Blanking Time [ms]	Auto-Restart Time [ms]	ON Pin Activity	Top Mark
FPF2116	200	30	480	Active HI	2116

### Functional Block Diagram

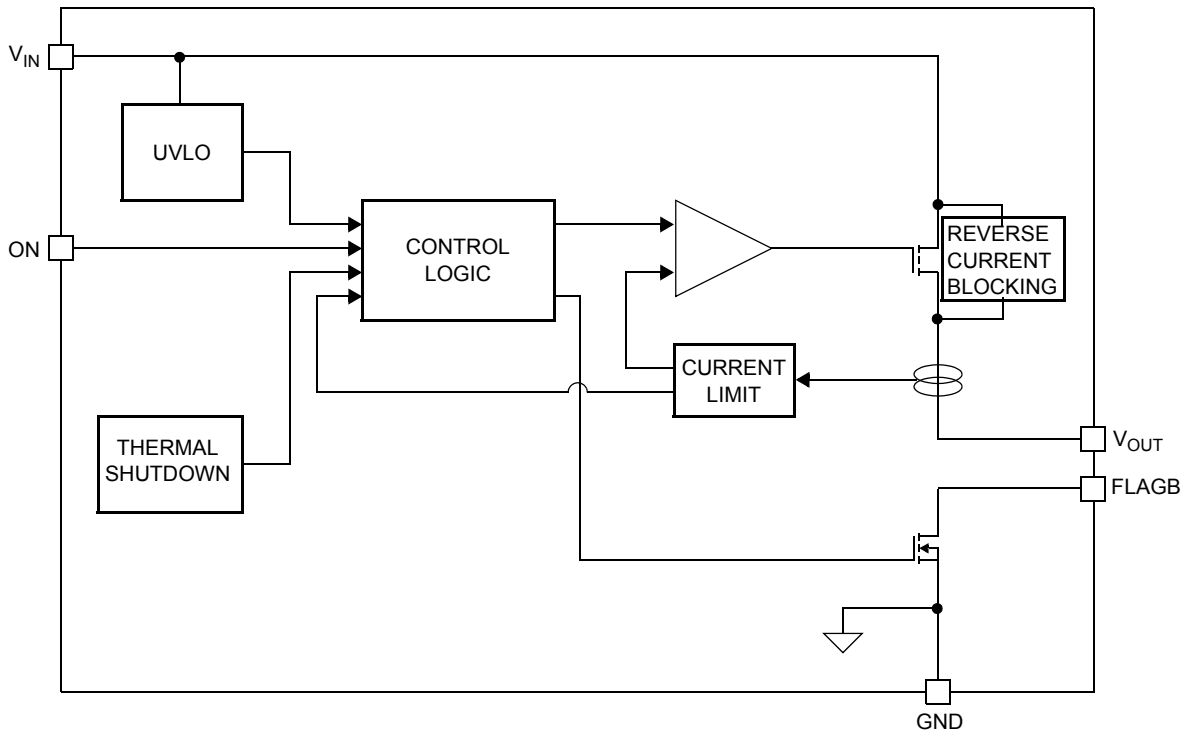

### Pin Configuration

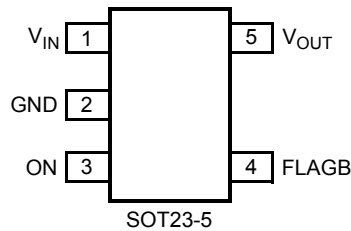

### Pin Description

Pin	Name	Function
1	$V_{IN}$	Supply Input: Input to the power switch and the supply voltage for the IC
2	GND	Ground
3	ON	ON Control Input
4	FLAGB	Fault Output: Active LO, open drain output which indicates an over current supply, under voltage or over temperature state.
5	$V_{OUT}$	Switch Output: Output of the power switch

## Absolute Maximum Ratings

Parameter	Min	Max	Unit
$V_{IN}$ , $V_{OUT}$ , ON, FLAGB to GND	-0.3	6	V
Power Dissipation @ $T_A = 25^\circ\text{C}$ (note 1)		667	mW
Operating Junction Temperature	-40	125	$^\circ\text{C}$
Storage Temperature	-65	150	$^\circ\text{C}$
Thermal Resistance, Junction to Ambient		150	$^\circ\text{C}/\text{W}$
Electrostatic Discharge Protection	HBM	4000	V
	MM	400	V

## Recommended Operating Range

Parameter	Min	Max	Unit
$V_{IN}$	1.8	5.5	V
Ambient Operating Temperature, $T_A$	-40	85	$^\circ\text{C}$

## Electrical Characteristics

$V_{IN} = 1.8$  to  $5.5\text{V}$ ,  $T_A = -40$  to  $+85^\circ\text{C}$  unless otherwise noted. Typical values are at  $V_{IN} = 3.3\text{V}$  and  $T_A = 25^\circ\text{C}$ .

Parameter	Symbol	Conditions	Min	Typ	Max	Units
<b>Basic Operation</b>						
Operating Voltage	$V_{IN}$		1.8		5.5	V
Quiescent Current	$I_Q$	$I_{OUT} = 0\text{mA}$	$V_{IN} = 1.8$ to $3.3\text{V}$	95		$\mu\text{A}$
			$V_{IN} = 3.3$ to $5.5\text{V}$	110	200	
$V_{IN}$ Shutdown Current		$V_{ON} = 0\text{V}$ , $V_{IN} = 5.5\text{V}$ , $V_{OUT}$ short to GND			2	$\mu\text{A}$
$V_{OUT}$ Shutdown Current		$V_{ON} = 0\text{V}$ , $V_{OUT} = 5.5\text{V}$ , $V_{IN}$ short to GND			2	$\mu\text{A}$
On-Resistance	$R_{ON}$	$V_{IN} = 3.3\text{V}$ , $I_{OUT} = 50\text{mA}$ , $T_A = 25^\circ\text{C}$		125	160	m $\Omega$
		$V_{IN} = 3.3\text{V}$ , $I_{OUT} = 50\text{mA}$ , $T_A = 85^\circ\text{C}$		150	200	
		$V_{IN} = 3.3\text{V}$ , $I_{OUT} = 50\text{mA}$ , $T_A = -40^\circ\text{C}$ to $+85^\circ\text{C}$	65		200	
ON Input Logic High Voltage (ON)	$V_{IH}$	$V_{IN} = 1.8\text{V}$	0.75			V
		$V_{IN} = 5.5\text{V}$	1.30			
ON Input Logic Low Voltage	$V_{IL}$	$V_{IN} = 1.8\text{V}$			0.5	V
		$V_{IN} = 5.5\text{V}$			1.0	
ON Input Leakage		$V_{ON} = V_{IN}$ or GND			1	$\mu\text{A}$
Off Switch Leakage	$I_{SWOFF}$	$V_{ON} = 0\text{V}$ , $V_{OUT} = 0\text{V}$			1	$\mu\text{A}$
FLAGB Output Logic Low Voltage		$V_{IN} = 5\text{V}$ , $I_{SINK} = 10\text{mA}$		0.1	0.2	V
		$V_{IN} = 1.8\text{V}$ , $I_{SINK} = 10\text{mA}$		0.15	0.3	
FLAGB Output High Leakage Current		$V_{IN} = 5\text{V}$ , Switch on			1	$\mu\text{A}$
<b>Protections</b>						
Current Limit	$I_{LIM}$	$V_{IN} = 3.3\text{V}$ , $V_{OUT} = 3.0\text{V}$	200	300	400	mA
Thermal Shutdown		Shutdown Threshold		140		$^\circ\text{C}$
		Return from Shutdown		130		
		Hysteresis		10		
Under Voltage Shutdown	UVLO	$V_{IN}$ Increasing	1.5	1.6	1.7	V
Under Voltage Shutdown Hysteresis				50		mV

## Electrical Characteristics Cont.

$V_{IN} = 1.8$  to  $5.5V$ ,  $T_A = -40$  to  $+85^{\circ}C$  unless otherwise noted. Typical values are at  $V_{IN} = 3.3V$  and  $T_A = 25^{\circ}C$ .

Parameter	Symbol	Conditions	Min	Typ	Max	Units
<b>Dynamic</b>						
Turn On Time	$t_{ON}$	$R_L = 500\Omega$ , $C_L = 0.1\mu F$		25		$\mu s$
Turn Off Time	$t_{OFF}$	$R_L = 500\Omega$ , $C_L = 0.1\mu F$		50		$\mu s$
$V_{OUT}$ Rise Time	$t_{RISE}$	$R_L = 500\Omega$ , $C_L = 0.1\mu F$		12		$\mu s$
$V_{OUT}$ Fall Time	$t_{FALL}$	$R_L = 500\Omega$ , $C_L = 0.1\mu F$		120		$\mu s$
Over Current Blanking Time	$t_{BLANK}$		15	30	60	ms
Auto-Restart Time	$t_{RESTART}$		240	480	960	ms
Short Circuit Response Time		$V_{IN} = V_{ON} = 3.3V$ . Moderate Over-Current Condition.		3		$\mu s$
		$V_{IN} = V_{ON} = 3.3V$ . Hard Short.		20		ns

**Note 1:** Package power dissipation on 1square inch pad, 2 oz copper board.

## Typical Characteristics

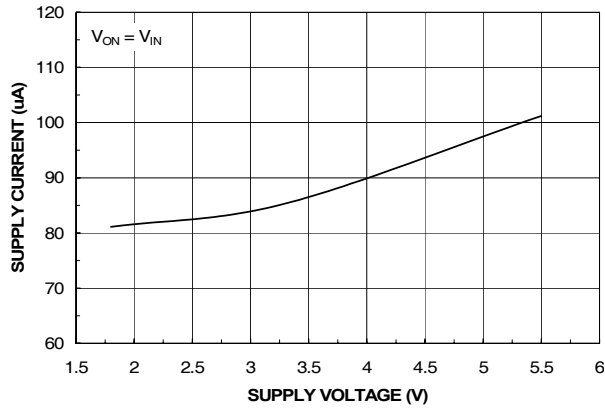

Figure 1. Quiescent Current vs. Input Voltage

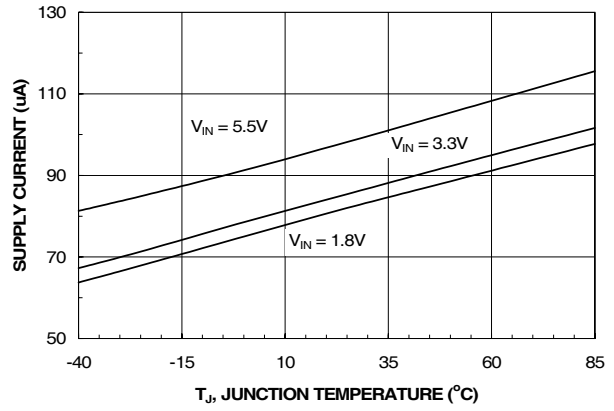

Figure 2. Quiescent Current vs. Temperature

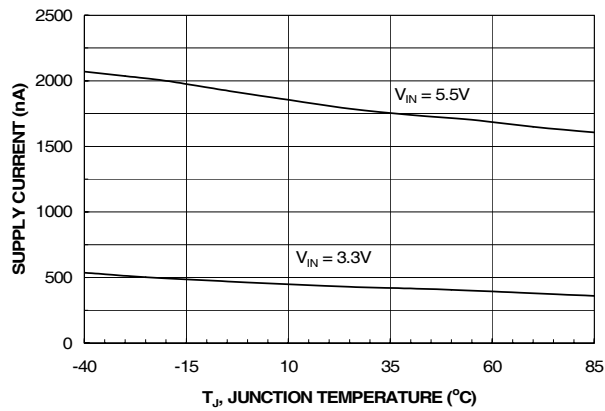

Figure 3.  $I_{SHUTDOWN}$  Current vs. Temperature

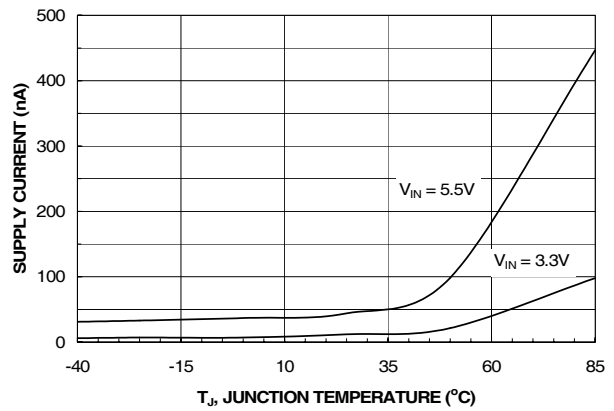

Figure 4.  $I_{SWITCH-OFF}$  Current vs. Temperature

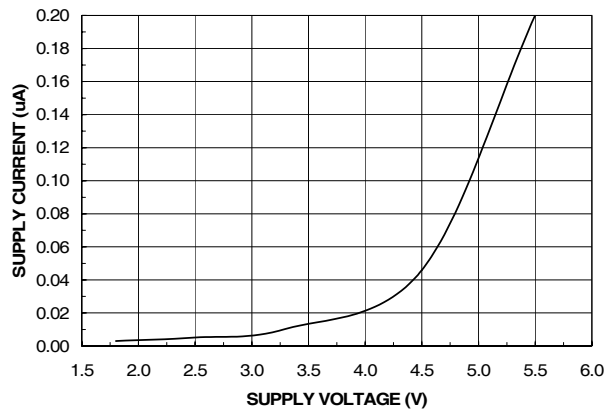

Figure 5. Reverse Current vs. Output Voltage

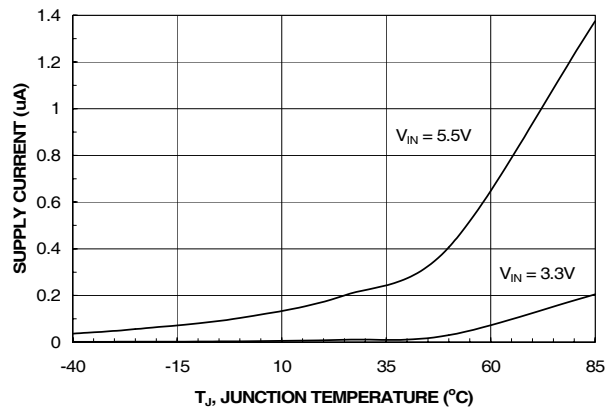

Figure 6. Reverse Current vs. Temperature

### Typical Characteristics

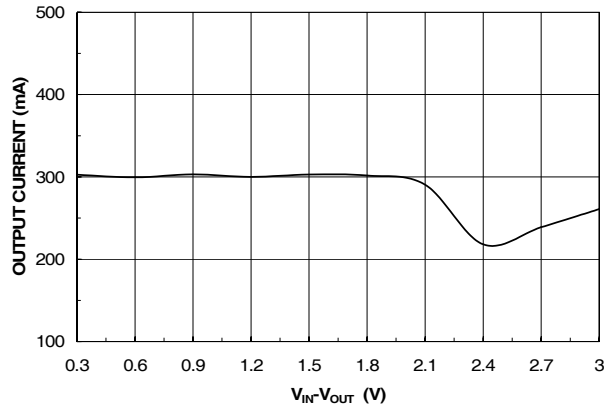

Figure 7. Current Limit vs. Output Voltage

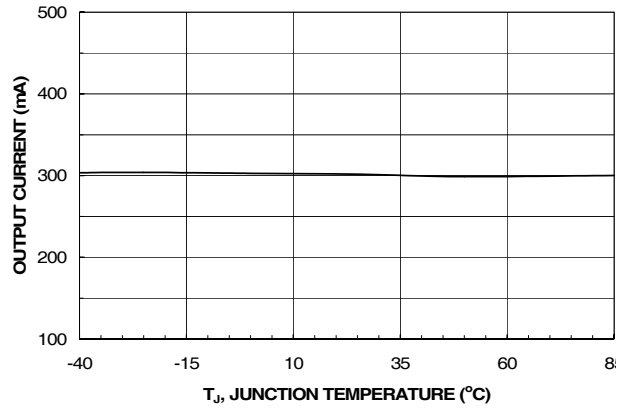

Figure 8. Current Limit vs. Temperature

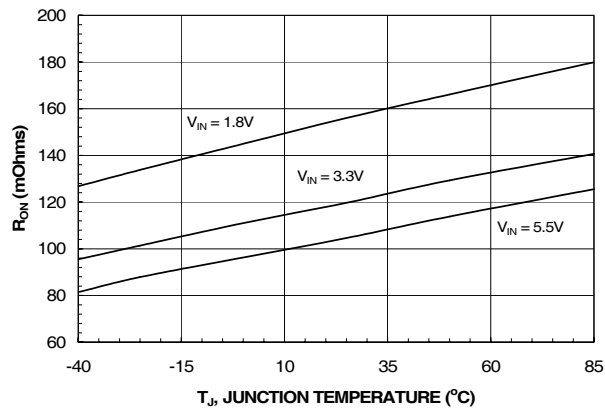

Figure 9.  $R_{ON}$  vs. Temperature

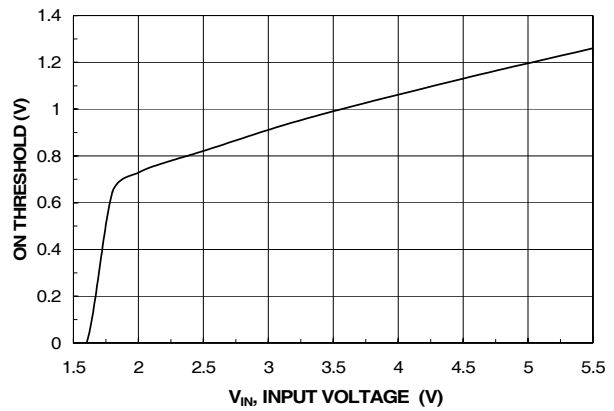

Figure 10. On Threshold vs.  $V_{IN}$

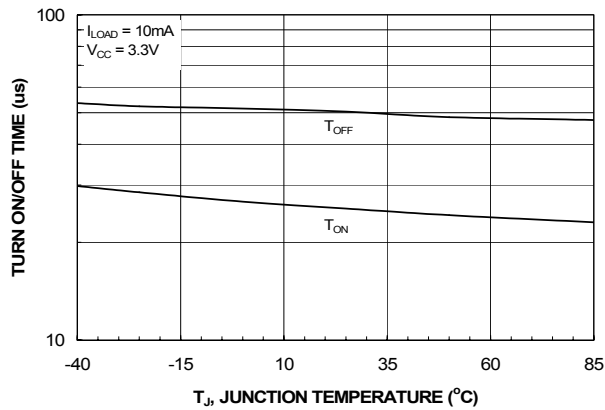

Figure 11.  $T_{ON}/T_{OFF}$  vs. Temperature

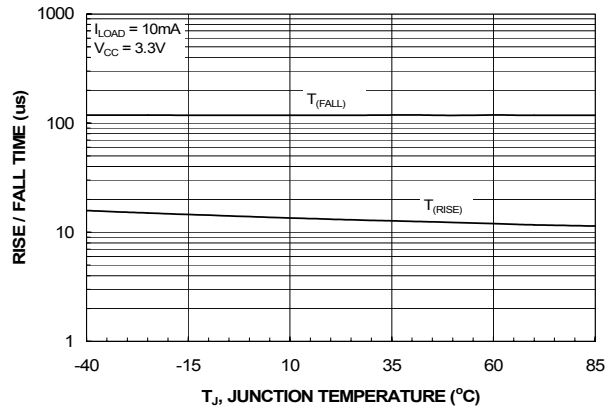

Figure 12.  $T_{RISE}/T_{FALL}$  vs. Temperature

### Typical Characteristics

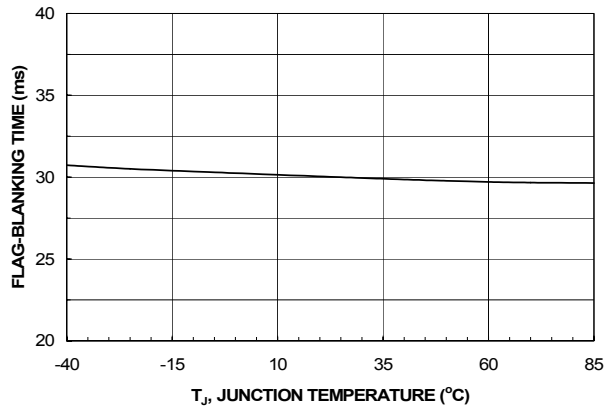

Figure 13. T<sub>BLANK</sub> vs. Temperature

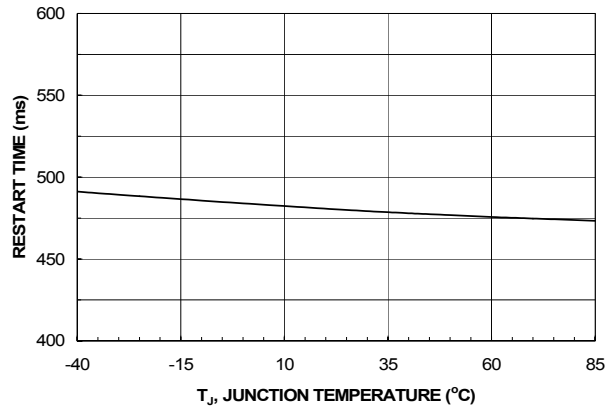

Figure 14. T<sub>RESTART</sub> vs. Temperature

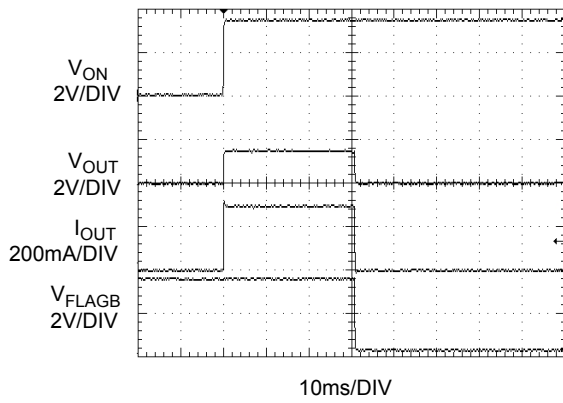

Figure 15. T<sub>BLANK</sub> Response

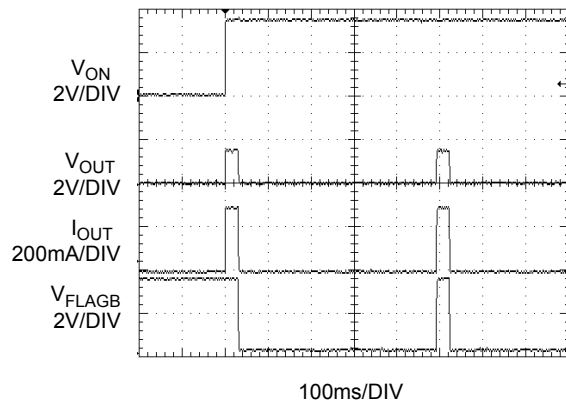

Figure 16. T<sub>RESTART</sub> Response

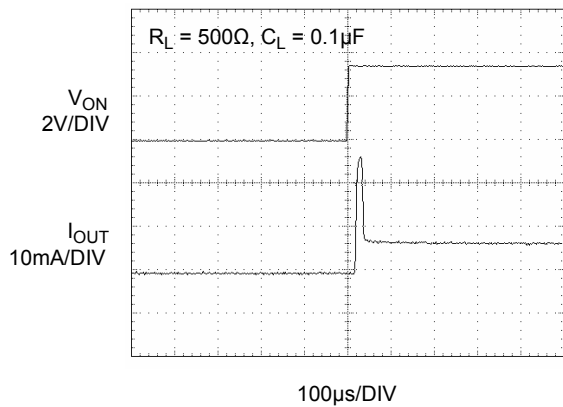

Figure 17. T<sub>ON</sub> Response

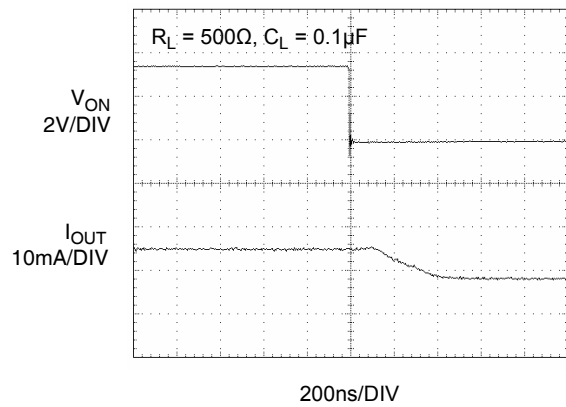

Figure 18. T<sub>OFF</sub> Response

### Typical Characteristics

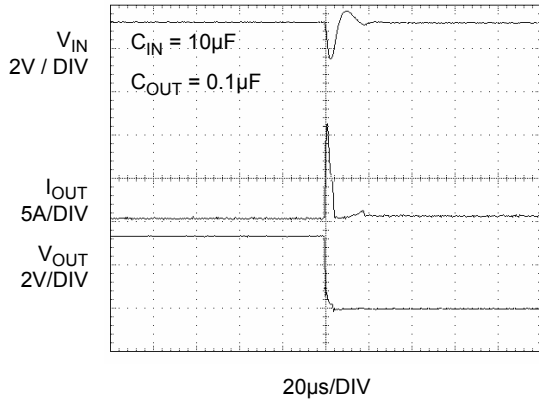

Figure 19. Short Circuit Response Time (Output Shorted to GND)

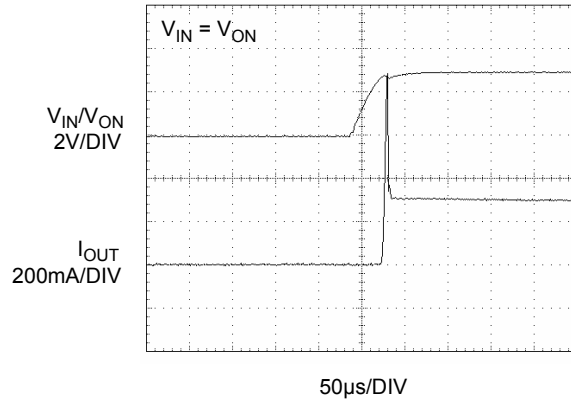

Figure 20. Current Limit Response (Switch power up to hard short)

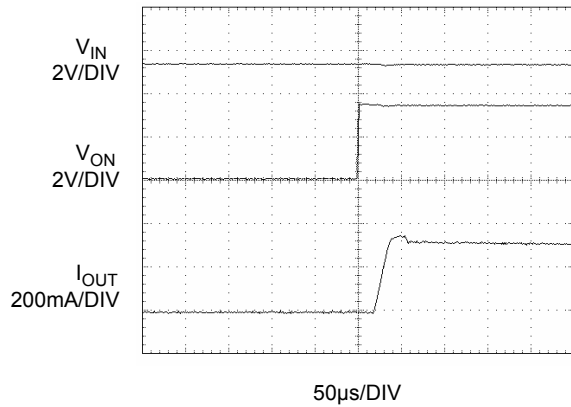

Figure 21. Current Limit Response Time (Output Shorted to GND by 10Ω, moderate short)



## Description of Operation

The FPF2116 is a current limited switch that protects systems and loads which can be damaged or disrupted by the application of high currents. The core of the device is a 0.125Ω P-channel MOSFET and a controller capable of functioning over a wide input operating range of 1.8-5.5V. The controller protects against system malfunctions through current limiting, under-voltage lockout and thermal shutdown. The current limit is preset for 200mA.

## On/Off Control

The ON pin controls the state of the switch. Activating ON continuously holds the switch in the on state so long as there is no fault. An under-voltage on  $V_{IN}$  or a junction temperature in excess of 150°C overrides the ON control to turn off the switch. In addition, excessive current will cause the switch to turn off. The part has an Auto-Restart feature which will automatically turn the switch on again after 480 ms. ON is active HI and has a low threshold making it capable of interfacing with low voltage signals. When the MOSFET is off, the body diode is disabled so no current can flow through it.

## Fault Reporting

Upon the detection of an over-current, an input under-voltage, or an over-temperature condition, the FLAGB signals the fault mode by immediately activating LO. The FLAGB goes LO at the end of the blanking time. It will remain LO during the fault and immediately returns HI at the end of the fault condition. FLAGB is an open-drain MOSFET which requires a pull-up resistor between  $V_{IN}$  and FLAGB. During shutdown, the pull-down on FLAGB is disabled to reduce current draw from the supply.

## Current Limiting

The current limit ensures that the current through the switch doesn't exceed 400mA while not limiting at less than 200mA. The part has a blanking time of 30 ms, nominally, during which the switch will act as a constant current source. At the end of the blanking time, the switch will be turned-off and the FLAGB pin will activate to indicate that current limiting has occurred.

## Under-Voltage Lockout

The under-voltage lockout turns-off the switch if the input voltage drops below the under-voltage lockout threshold. With the ON pin active the input voltage rising above the under-voltage lockout threshold will cause a controlled turn-on of the switch which limits current over-shoots.

## Thermal Shutdown

The thermal shutdown protects the part from internally or externally generated excessive temperatures. During an over-temperature condition the FLAGB is activated and the switch is turned-off. The switch automatically turns-on again if temperature of the die drops below the threshold temperature.

## Application Information

### Typical Application

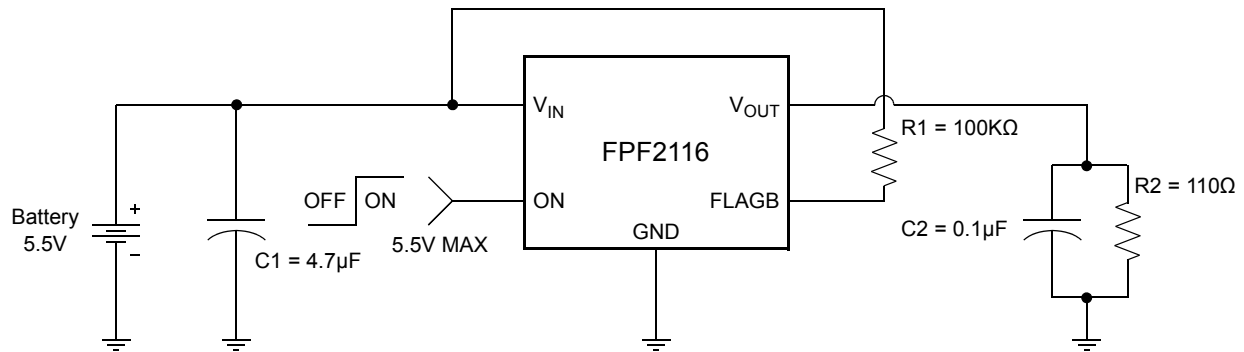

### Input Capacitor

To limit the voltage drop on the input supply caused by transient in-rush currents when the switch turns-on into a discharged load capacitor or a short-circuit, a capacitor needs to be placed between  $V_{IN}$  and GND. A  $4.7\mu\text{F}$  ceramic capacitor,  $C_{IN}$ , must be placed close to the  $V_{IN}$  pin. A higher value of  $C_{IN}$  can be used to further reduce the voltage drop experienced as the switch is turned on into a large capacitive load.

### Board Layout

For best performance, all traces should be as short as possible. To be most effective, the input and output capacitors should be placed close to the device to minimize the effects that parasitic trace inductances may have on normal and short-circuit operation. Using wide traces for  $V_{IN}$ ,  $V_{OUT}$  and GND will help minimize parasitic electrical effects along with minimizing the case to ambient thermal impedance.

### Output Capacitor

A  $0.1\mu\text{F}$  capacitor  $C_{OUT}$ , should be placed between  $V_{OUT}$  and GND. This capacitor will prevent parasitic board inductances from forcing  $V_{OUT}$  below GND when the switch turns-off. The total output capacitance needs to be kept below a maximum value,  $C_{OUT(max)}$ , to prevent the part from registering an over-current condition and turning off the switch. The maximum output capacitance can be determined from the following formula,

$$C_{OUT(max)} = \frac{I_{LIM(min)} \times t_{BLANK(min)}}{V_{IN}} \quad (1)$$

### Power Dissipation

During normal operation as a switch, the power dissipation is small and has little effect on the operating temperature of the part. The parts with the higher current limits will dissipate the most power and that will only be,

$$P = (I_{LIM})^2 \times R_{DS} = (0.4)^2 \times 0.125 = 20\text{mW} \quad (2)$$

When in current limit the maximum power dissipation will occur when the output is shorted to ground. The power dissipation will scale by the Auto-Restart Time,  $t_{RSTR}$ , and the Over Current Blanking Time,  $t_{BLANK}$ , so that the maximum power dissipated is typically,

$$\begin{aligned} P(max) &= \frac{t_{BLANK}}{t_{RETRY} + t_{BLANK}} \times V_{IN(max)} \times I_{LIM(max)} \\ &= \frac{60}{60 + 960} \times 5.5 \times 0.4 = 130\text{mW} \end{aligned} \quad (3)$$

Dimensional Outline and Pad Layout

Package MA05B

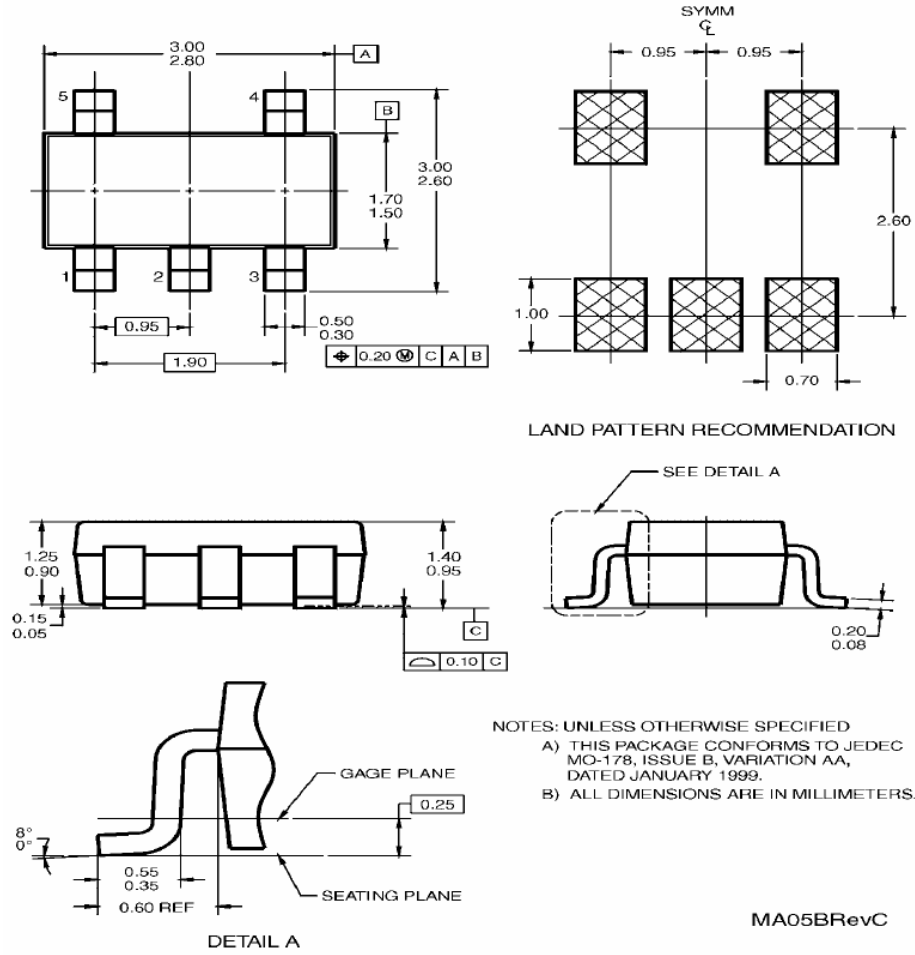





MA05BRevC

5-Lead SOT23, JEDEC MO-178, 1.6mm  
 Package Number MA05B



**TRADEMARKS**

The following includes registered and unregistered trademarks and service marks, owned by Fairchild Semiconductor and/or its global subsidiaries, and is not intended to be an exhaustive list of all such trademarks.

- |   |   |                                  |   |
|---|---|----------------------------------|---|
| Build it Now™   | FPS™  | PDP SPM™                         | The Power Franchise®  |
| CorePLUS™   | F-PFS™  | Power-SPM™                       | the   |
| CorePOWER™  | FRFET®  | PowerTrench®                     | <b>power</b>  |
| CROSSVOLT™  | Global Power ResourceSM   | Programmable Active Droop™       | franchise   |
| CTL™  | Green FPS™  | QFET®                            | TinyBoost™  |
| Current Transfer Logic™   | Green FPS™ e-Series™  | QS™                              | TinyBuck™   |
| EcoSPARK®   | GTO™  | Quiet Series™                    | TinyLogic®  |
| EfficientMax™   | IntelliMAX™   | RapidConfigure™                  | TINYOPTO™   |
| EZSWITCH™ *   | ISOPLANAR™  | Saving our world, 1mW at a time™ | TinyPower™  |
|  | MegaBuck™   | SmartMax™                        | TinyPWM™  |
|  | MICROCOUPLER™   | SMART START™                     | TinyWire™   |
| Fairchild®  | MicroFET™   | SPM®                             | µSerDes™  |
| Fairchild Semiconductor®  | MicroPak™   | STEALTH™                         |  |
| FACT Quiet Series™  | MillerDrive™  | SuperFET™                        | UHC®  |
| FACT®   | MotionMax™  | SuperSOT™-3                      | Ultra FRFET™  |
| FAST®   | Motion-SPM™   | SuperSOT™-6                      | UniFET™   |
| FastvCore™  | OPTOLOGIC®  | SuperSOT™-8                      | VCX™  |
| FlashWriter® *  | OPTOPLANAR®   | SupreMOS™                        | VisualMax™  |
|   |  | SyncFET™                         |   |
|   |   | SYSTEM GENERAL®                  |   |

\* EZSWITCH™ and FlashWriter® are trademarks of System General Corporation, used under license by Fairchild Semiconductor.

**DISCLAIMER**

FAIRCHILD SEMICONDUCTOR RESERVES THE RIGHT TO MAKE CHANGES WITHOUT FURTHER NOTICE TO ANY PRODUCTS HEREIN TO IMPROVE RELIABILITY, FUNCTION, OR DESIGN. FAIRCHILD DOES NOT ASSUME ANY LIABILITY ARISING OUT OF THE APPLICATION OR USE OF ANY PRODUCT OR CIRCUIT DESCRIBED HEREIN; NEITHER DOES IT CONVEY ANY LICENSE UNDER ITS PATENT RIGHTS, NOR THE RIGHTS OF OTHERS. THESE SPECIFICATIONS DO NOT EXPAND THE TERMS OF FAIRCHILD'S WORLDWIDE TERMS AND CONDITIONS, SPECIFICALLY THE WARRANTY THEREIN, WHICH COVERS THESE PRODUCTS.

**LIFE SUPPORT POLICY**

FAIRCHILD'S PRODUCTS ARE NOT AUTHORIZED FOR USE AS CRITICAL COMPONENTS IN LIFE SUPPORT DEVICES OR SYSTEMS WITHOUT THE EXPRESS WRITTEN APPROVAL OF FAIRCHILD SEMICONDUCTOR CORPORATION.

As used herein:

- Life support devices or systems are devices or systems which, (a) are intended for surgical implant into the body or (b) support or sustain life, and (c) whose failure to perform when properly used in accordance with instructions for use provided in the labeling, can be reasonably expected to result in a significant injury of the user.
- A critical component in any component of a life support, device, or system whose failure to perform can be reasonably expected to cause the failure of the life support device or system, or to affect its safety or effectiveness.

**ANTI-COUNTERFEITING POLICY**

Fairchild Semiconductor Corporation's Anti-Counterfeiting Policy. Fairchild's Anti-Counterfeiting Policy is also stated on our external website, [www.fairchildsemi.com](http://www.fairchildsemi.com), under Sales Support.

Counterfeiting of semiconductor parts is a growing problem in the industry. All manufactures of semiconductor products are experiencing counterfeiting of their parts. Customers who inadvertently purchase counterfeit parts experience many problems such as loss of brand reputation, substandard performance, failed application, and increased cost of production and manufacturing delays. Fairchild is taking strong measures to protect ourselves and our customers from the proliferation of counterfeit parts. Fairchild strongly encourages customers to purchase Fairchild parts either directly from Fairchild or from Authorized Fairchild Distributors who are listed by country on our web page cited above. Products customers buy either from fairchild directly or from Authorized Fairchild Distributors are genuine parts, have full traceability, meet Fairchild's quality standards for handling and storage and provide access to Fairchild's full range of up-to-date technical and product information. Fairchild and our Authorized Distributors will stand behind all warranties and will appropriately address and warranty issues that may arise. Fairchild will not provide any warranty coverage or other assistance for parts bought from Unauthorized Sources. Fairchild is committed to combat this global problem and encourage our customers to do their part in stopping this practice by buying direct or from authorized distributors.

**PRODUCT STATUS DEFINITIONS**

**Definition of Terms**

Datasheet Identification	Product Status	Definition
Advance Information	Formative / In Design	Datasheet contains the design specifications for product development. Specifications may change in any manner without notice.
Preliminary	First Production	Datasheet contains preliminary data; supplementary data will be published at a later date. Fairchild Semiconductor reserves the right to make changes at any time without notice to improve design.
No Identification Needed	Full Production	Datasheet contains final specifications. Fairchild Semiconductor reserves the right to make changes at any time without notice to improve the design.
Obsolete	Not In Production	Datasheet contains specifications on a product that is discontinued by Fairchild Semiconductor. The datasheet is for reference information only.