



USER MANUAL

MODEL 460 Series G.703 Coax to Twisted Pair Adapter (Balun)



WARRANTY

Patton Electronics warrants all Model 460 components to be free from defects, and will—at our option—repair or replace the product should it fail within one year from the first date of shipment. This warranty is limited to defects in workmanship or materials, and does not cover customer damage, abuse or unauthorized modification. If this product fails or does not perform as warranted, your sole recourse shall be repair or replacement as described above. Under no condition shall **Patton Electronics** be liable for any damages incurred by the use of this product. These damages include, but are not limited to, the following: lost profits, lost savings and incidental or consequential damages arising from the use of or inability to use this product. **Patton Electronics** specifically disclaims all other warranties, expressed or implied, and the installation or use of this product shall be deemed an acceptance of these terms by the user.

SERVICE AND SUPPORT

All warranty and non-warranty repairs must be returned freight prepaid and insured to Patton Electronics. All returns must have a Return Materials Authorization number on the outside of the shipping container. This number may be obtained from Patton Electronics Technical Service at **(301) 975-1007**; <http://www.patton.com>; or, support@patton.com. **NOTE:** Packages received without an RMA number will not be accepted. Patton Electronics' technical staff is also available to answer any questions that might arise concerning the installation or use of your Model 460. Technical Service hours: **8AM to 5PM EST, Monday through Friday.**

CE NOTICE

The CE symbol on your Patton Electronics equipment indicates that it is in compliance with the Electromagnetic Compatibility (EMC) directive of the European Union (EU). A Certificate of Compliance is available by contacting Patton Technical Support.

PRODUCT DESCRIPTION

The Patton Model 460 Series allow 75 Ohm coax hardware to communicate with 120 Ohm twisted pair equipment. The Model 460 Series specifically address the ONP requirement that European PTTs offer 120 Ohm twisted pair terminations to their customers. Some PTTs and private carriers are standardized on 75 Ohm coax, or have customers whose CPE has only 75 Ohm coax connections. The Model 460 Series present a ready solution to this termination mismatch by allowing a bi-directional conversion of coax (75 Ohm) to a twisted pair (120 Ohm), supporting data rates to E1 (2.048 Mbps). The signals

output by them are scaled to match the pulse shape requirements specified by the CCITT G.703 standard.

The Model 460s come in the following versions (see below):

460

- A shielded RJ-45 jack.
- 460M: Two male coaxial connectors (i.e., center conductor is a pin).
- 460F: Two female coaxial connectors (i.e., center conductor is a receptacle).

460-TBP

- A 4-position terminal block.
- 460M-TBP: Two male coaxial connectors (i.e., center conductor is a pin).
- 460F-TBP: Two female coaxial connectors (i.e., center conductor is a receptacle).

460MC

- Two male coaxial connectors at the end of a coax pigtail cable. (i.e., center conductor is a pin). See photo on front cover of manual.

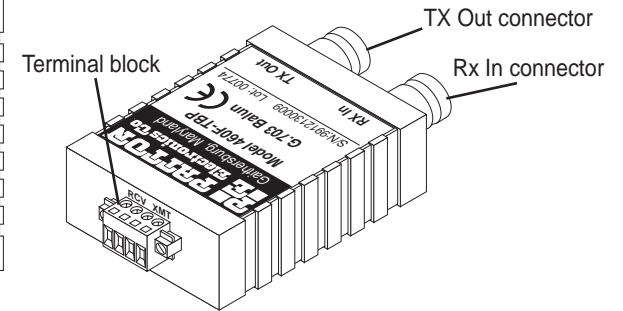
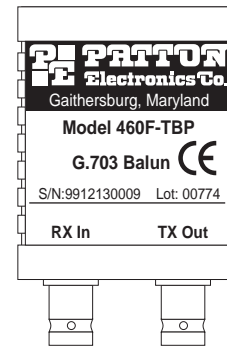

Model 460-TBP

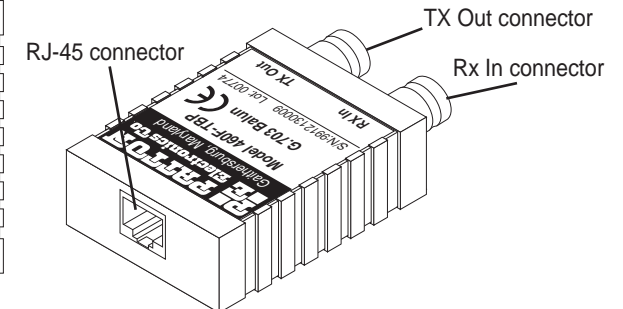
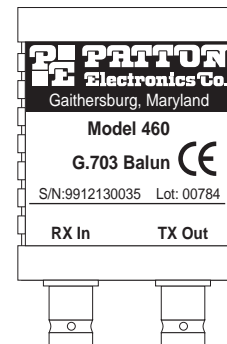

Model 460

RJ-45 Jack and Terminal Block Descriptions

Shielded RJ-45 Jack:

- Pins 1 and 2 are the balanced inputs. The balanced signals are converted to an unbalanced signal on the center conductor of the TX Out coax connector.
- The unbalanced signal from the RX In coax connector is converted to balanced signals on pins of the RJ-45.
- The shield of the RX In connector may be connected to RJ-45 pin 6 by jumper JP2 (on).
- The shield of the TX Out connector is always connected to the shield around the RJ-45 connector. This connection may also be connected to RJ-45 pin 3 via JP1 (on).

Terminal Block:

- Has a 4 pin terminal block for a twisted pair connection.
- The 460M has male coaxial connectors (i.e., center conductor is a pin) and the 460F has female coaxial connectors (i.e., center conductor is a receptacle).

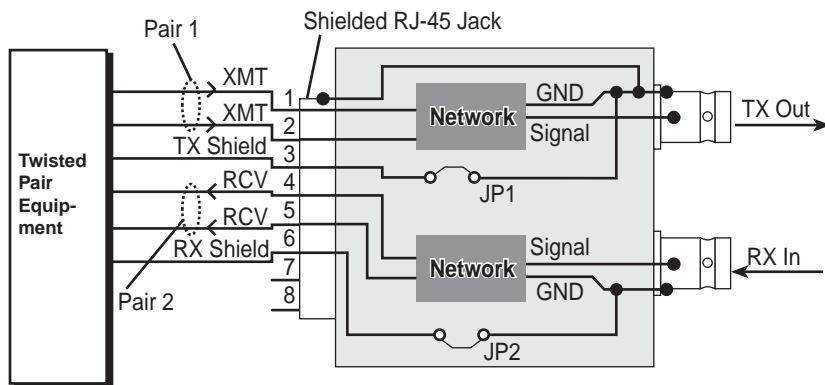
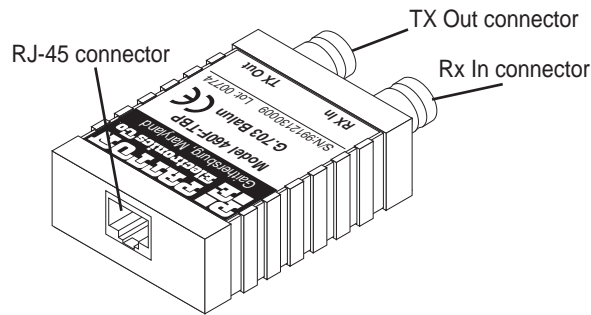

CONFIGURATION

NOTE: The Model 460-TBP does not require configuration; go to section "INSTALLATION" on page 2. The following section describes configuring the Model 460. The Model 460 Series are pre-set to work in most applications without additional configuration. The only parameter that is user-configurable is the shield connection between the 75 Ohm coax and 120 Ohm interfaces. The diagram on the following page shows how the shield is connected between the modular jack and dual BNCs. Removing the jumper breaks the connection.

The Model 460 is most often used to bi-directionally convert CPE twisted pair terminations to CPE coaxial terminations.

RJ-45 (120 ohm) Jumper Coax BNC (75 ohm)

Pin 3 (TX Shield)..... JP1.....TX Out Shield
 Pin 6 (RX Shield).....JP2.....RX In Shield

The factory setting leaves both jumpers JP1 and JP2 (see figure above) in place, thus passing both shield connections through. To break one or both of the shield connections, follow the instructions on the next page.

- 1) Insert a flat blade screwdriver into the slot on the side of the Model 460 case and twist. The case will pop open, exposing the PC board.
- 2) Holding the PC board with the modular jack facing left, locate jumper JP1 toward the top of the board and JP2 toward the bottom of the board. Remove the desired jumper(s) to break one or both shield connections.
NOTE: Do not lose the jumper(s).
- 3) Re-align the case halves and end inserts and snap the case halves back together.

INSTALLATION

The sections on the next page describe installing the following:

- Model 460
- Model 460-TBP

Refer to the appropriate section on the following page to install your unit.

Installing the Model 460

Do the following:

- 1) Refer to the pin configuration below when assembling the cable that will connect to the RJ-45 jack.

RJ-45 Pin(s)	Function
1 and 2.....	TX pair
3.....	TX shield
4 and 5.....	RX pair
6.....	RX shield

- 2) Plug the modular cable connector into the RJ-45 jack.
- 3) Connect the coaxial cables to the TX Out and RX In connectors. Congratulations, you have finished installing the Model 460!

Installing the Model 460-TBP

Do the following:

- 1) Strip the outer jacket insulation from the twisted pairs about 1 inch.
- 2) Strip back the insulation on each of the wires about .25 inches.
- 3) Connect one pair of wires to the two XMT (transmit) positions on the terminal block. The Model 460-TBP is not polarity sensitive so either wire may connect to either pole. See figure at upper right.
- 4) Connect the other pair of wires to the two RCV (receive) positions on the terminal block.
- 5) Connect the coaxial cables to the TX Out and RX In connectors.

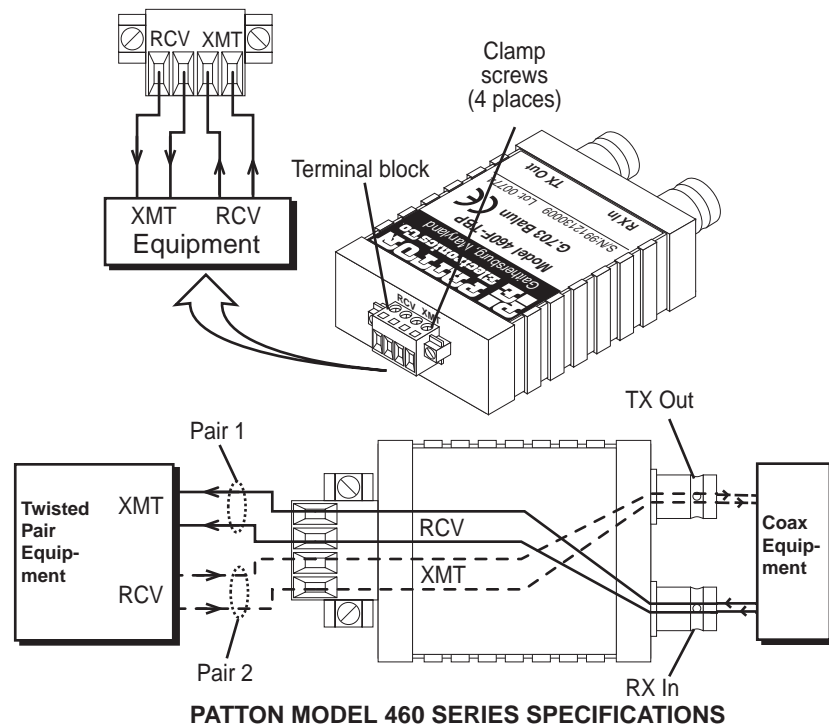

PATTON MODEL 460 SERIES SPECIFICATIONS

Transmission Line:	ITU/CCITT G.703 (unstructured)
Data Rate:	2.048 Mbps maximum
Unbalanced Coaxial Connection:	Dual coax BNC connectors, male or female (RG 59 or 2002 coax) and Nominal Line Impedance = 75 Ohms
Balanced Twisted Pair Connection:	Single 8-pin RJ-45 jack, shielded (two twisted-pair), Nominal Line Impedance = 120 Ohms and 4-position, removable terminal block
Power Supply:	None required, passive device
Operating Temperature:	0-50° Celcius (32-122° Fahrenheit)
Coaxial Twisted Pair Isolation:	1500V rms
Compliance:	CE approved
Dimensions:	0.8H x 1.7W x 2.7D in. (6.86H x 4.32W x 2.03D cm.)

