



GLL170-P332

GLL170

FIBER-OPTIC SENSORS

SICK
Sensor Intelligence.



Ordering information

Type	Part no.
GLL170-P332	6063334

Other models and accessories → www.sick.com/GLL170

Illustration may differ



Detailed technical data

Features

Type	Stand-alone
Dimensions (W x H x D)	10 mm x 31.7 mm x 72.5 mm
Housing design (light emission)	Rectangular
Sensing range max.	0 mm ... 190 mm, Proximity system ^{1) 2)} 0 mm ... 800 mm, Through-beam system ³⁾
Sensing range	0 mm ... 160 mm, Proximity system ^{1) 2)} 0 mm ... 700 mm, Through-beam system ³⁾
Type of light	Visible red light
Light source	LED ⁴⁾
Wave length	632 nm
Adjustment	Potentiometer, 8 turns ⁵⁾
Indication	LED
Display	Status LEDs

¹⁾ Object with 90 % reflectance (referred to standard white, DIN 5033).

²⁾ LL3-DK06.

³⁾ LL3-TB02.

⁴⁾ Average service life: 100,000 h at T_U = +25 °C.

⁵⁾ Sensitivity scale 230°.

Mechanics/electronics

Supply voltage	10 V DC ... 30 V DC ¹⁾
Ripple	≤ 10 % ²⁾
Current consumption	30 mA ³⁾
Switching output	PNP
Number of switching outputs	1
Switching mode	Light/dark switching
Switching mode selector	Selectable via rotary switch
Output current I_{max.}	≤ 100 mA
Response time	≤ 250 μs ⁴⁾
Switching frequency	2 kHz
Time functions	Without time delay Off delay
Delay time	Selectable via rotary switch, 0 ms ... 40 ms
Connection type	Cable, 3-wire, 2 m ⁵⁾
Cable material	PVC
Conductor cross-section	0.2 mm ²
Cable diameter	3.8 mm
Circuit protection	A ⁶⁾ B ⁷⁾ C ⁸⁾ D ⁹⁾
Protection class	III
Weight	63 g
Housing material	Plastic, PC/POM
Tightening torque, max.	0.5 Nm
Enclosure rating	IP66 ¹⁰⁾
Ambient operating temperature	-25 °C ... +55 °C
Ambient storage temperature	-40 °C ... +70 °C
UL File No.	NRKH2.E300503 & NRKH8.E300503

¹⁾ Limit values.

²⁾ May not exceed or fall below U_y tolerances.

³⁾ Without load.

⁴⁾ Signal transit time with resistive load.

⁵⁾ Do not bend below 0 °C.

⁶⁾ A = V_S connections reverse-polarity protected.

⁷⁾ B = inputs and output reverse-polarity protected.

⁸⁾ C = interference suppression.

⁹⁾ D = outputs overcurrent and short-circuit protected.

¹⁰⁾ With correctly attached fibre-optic cable LL3.

Safety-related parameters

MTTF_D	760 years
DC_{avg}	0%

Classifications

ECl@ss 5.0	27270905
ECl@ss 5.1.4	27270905
ECl@ss 6.0	27270905
ECl@ss 6.2	27270905
ECl@ss 7.0	27270905
ECl@ss 8.0	27270905
ECl@ss 8.1	27270905
ECl@ss 9.0	27270905
ECl@ss 10.0	27270905
ECl@ss 11.0	27270905
ETIM 5.0	EC002651
ETIM 6.0	EC002651
ETIM 7.0	EC002651
UNSPSC 16.0901	39121528

Connection diagram

Cd-043

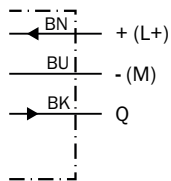

Adjustments possible

GLL170

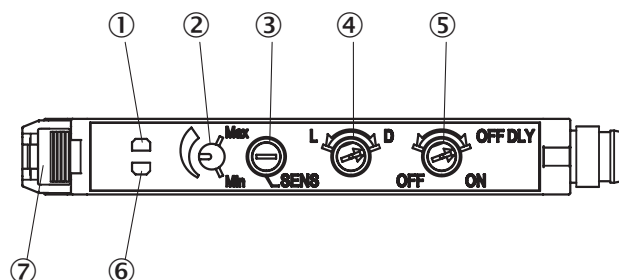

- ① LED indicator orange, lights up when switching output is active
- ② Sensitivity scale 230°
- ③ Sensitivity control: potentiometer, 8 turns
- ④ Selector switch: "L.ON" (light switching) / "D.ON" (dark switching)
- ⑤ OFF delay selector switch: "ON" (on) / "OFF" (off), 40 ms fixed
- ⑥ LED signal strength indicator green, lights up, when light received < 0.9 or > 1.1 (switching threshold = 1)
- ⑦ Locking the fiber-optic cables



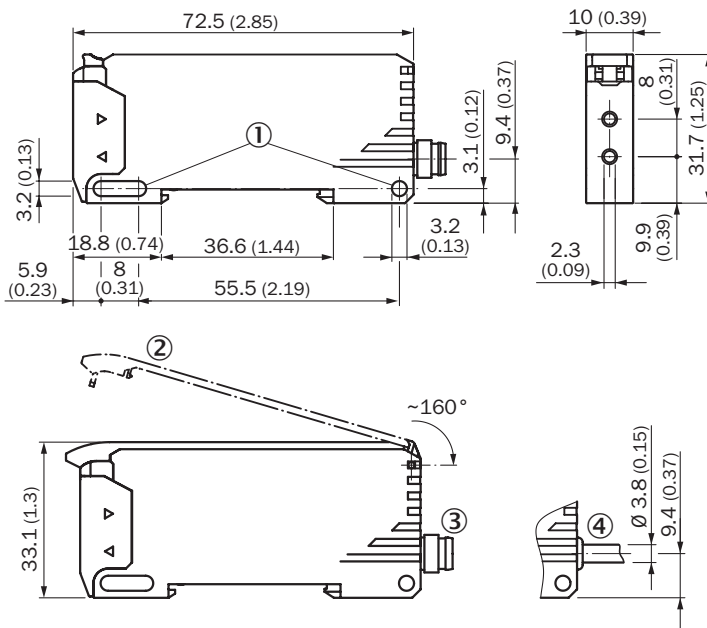

Dimensional drawing (Dimensions in mm (inch))



- ① Mounting holes
- ② Protective hood (optional), opens approx. 160°
- ③ Connector M8
- ④ Cable

Recommended accessories

Other models and accessories → www.sick.com/GLL170

	Brief description	Type	Part no.
Device protection (mechanical)			
	Protective Hood for GLL170, opens approx. 160°, PC	BF-GLL170	5336263
Mounting brackets and plates			
	Mounting bracket, steel, zinc coated, without mounting hardware	BEF-WLL180	5325812
Plug connectors and cables			
	Head A: female connector, M8, 3-pin, straight Head B: - Cable: unshielded	DOS-0803-G	7902077
	Head A: female connector, M8, 3-pin, angled Head B: - Cable: unshielded	DOS-0803-W	7902078
	Head A: male connector, M8, 3-pin, straight Head B: - Cable: unshielded	STE-0803-G	6037322

SICK AT A GLANCE

SICK is one of the leading manufacturers of intelligent sensors and sensor solutions for industrial applications. A unique range of products and services creates the perfect basis for controlling processes securely and efficiently, protecting individuals from accidents and preventing damage to the environment.

We have extensive experience in a wide range of industries and understand their processes and requirements. With intelligent sensors, we can deliver exactly what our customers need. In application centers in Europe, Asia and North America, system solutions are tested and optimized in accordance with customer specifications. All this makes us a reliable supplier and development partner.

Comprehensive services complete our offering: SICK LifeTime Services provide support throughout the machine life cycle and ensure safety and productivity.

For us, that is “Sensor Intelligence.”

WORLDWIDE PRESENCE:

Contacts and other locations –www.sick.com