

KEMET Part Number: SC-15-10J
(UALSC1510J0000)

KEMET, SC-J, AC Line Filters, Common Mode, 1000 μ H

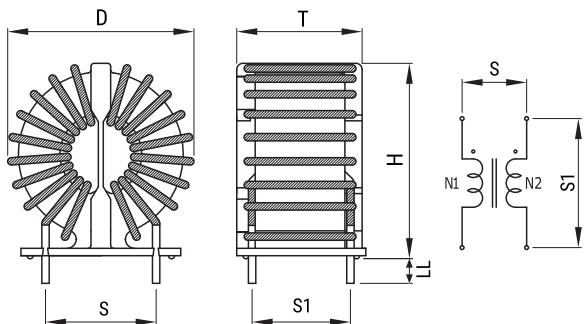

Dimensions

D	44mm MAX
T	30mm MAX
H	44mm MAX
LL	5mm +/-2mm
S	18mm NOM

Packaging Specifications

Packaging:	Tray
Packaging Quantity:	160
Weight:	75 g

General Information

Series:	SC-J
Style:	Through-Hole
RoHS:	Yes
Notes:	Lead Spacing (S/S1) Are For Reference Only.
Miscellaneous:	Temperature Rise Maximum: 55 K

Specifications

Voltage AC:	250 VAC
Inductance:	1 mH (100 kHz)
Current:	15 A
Temperature Range:	-25/+105°C
DC Resistance:	12 mOhms