

AC Filter 2-Stage, Broad Band Attenuation



new



Quick connect terminals 6.3x0.8 mm
Case MF



Quick connect terminals 6.3x0.8 mm
Case O9



Bolt and nut M4
Case MB



Description

- Chassis:
Screw-on mounting, from top
- Line filter in standard and medical version, 2 stages
- 3 designs: Design C, Design D, Design F
- Quick connect-, wired- or bolt terminals
- High symmetrical and asymmetrical attenuation in the frequency range of 100kHz up to 300MHz

Approvals

- VDE Certificate Number: 40030410
- UL File Number: E72928

Characteristics

- Designed for current applications of 1 - 36 A
- Protection against interference voltage from the mains
Possible interferences generated in the equipment are strongly attenuated
- Especially designed for industrial applications such as: Frequency Converters, Stepper Motor Drives, UPS-Systems, Inverters
- Suitable for use in equipment according to IEC/UL 60950
Suitable for use in medical equipment according to IEC/UL 60601-1

Other versions on request

- Version with wire connection

References

Alternative: Standard version

Weblinks

[pdf-datasheet](#), [html-datasheet](#), [General Product Information](#), [Approvals](#), [CE declaration of conformity](#), [RoHS](#), [CHINA-RoHS](#), [REACH](#), [e-Shop](#), [SCHURTER-Stock-Check](#), [Distributor-Stock-Check](#), [Detailed request for product](#)

Technical Data

Ratings IEC	1 - 36A @ Ta 40 °C / 250 VAC; 50Hz
Ratings UL/CSA	1 - 30A @ Ta 40 °C / 125/250VAC; 60Hz
Leakage Current	standard < 0.5 mA (250 V / 60 Hz) medical (M5) < 5 µA resp. (M80) < 80 µA (250 V / 60 Hz)
Dielectric Strength	1.7 kVDC between L-N 2.75 kVDC between L/N-PE Test voltage (2 sec)
Allowable Operation Temp.	-25 °C to 100 °C
Climatic Category	25/100/21 acc. to IEC 60068-1
Degree of Protection	from rear-side IP 20 IEC 60529
Protection Class	Suitable for appliances with protection class I acc. to IEC 61140
Terminal	Quick connect terminal 6.3 x 0.8 mm Bolt and nut M4
Material: Housing	Aluminum

Line Filter	Standard and Medical Version, IEC 60939, UL 1283 ed.5, CSA C22.2 no. 8 Technical Details
MTBF	> 200'000h acc. to MIL-HB-217 F

Dimension

Case 09 with quick connect terminals

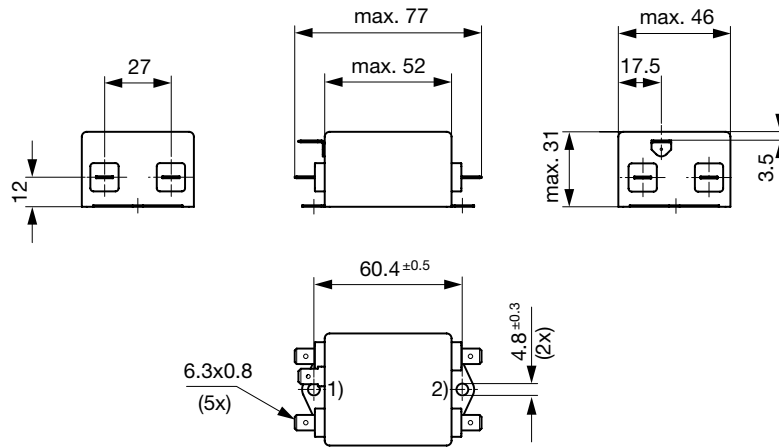

- 1) Line
- 2) Load

Case MB with quick connect terminals

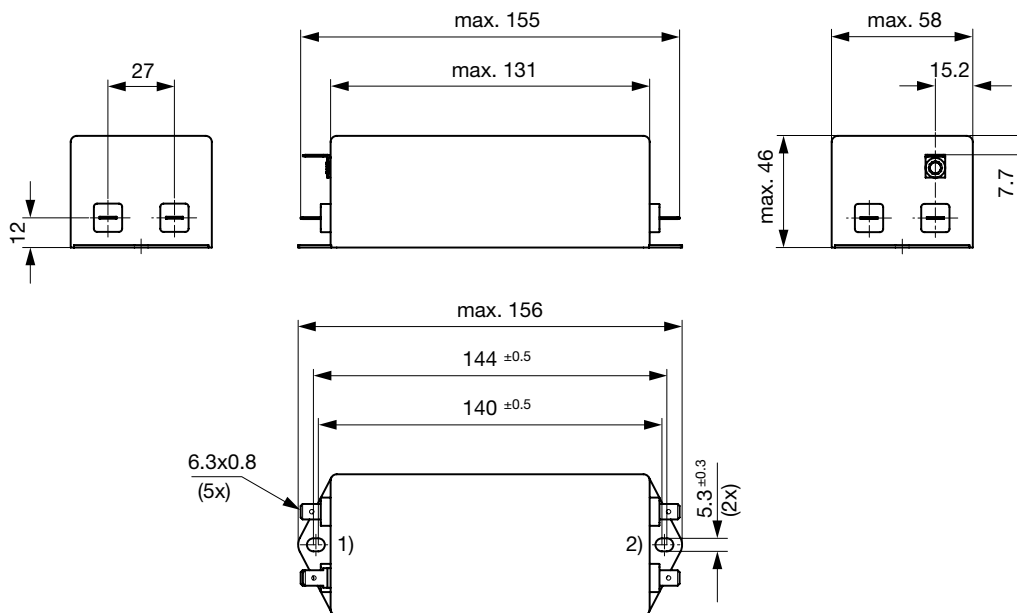

- 1) Line
- 2) Load

Case MB with bolt and nut M4

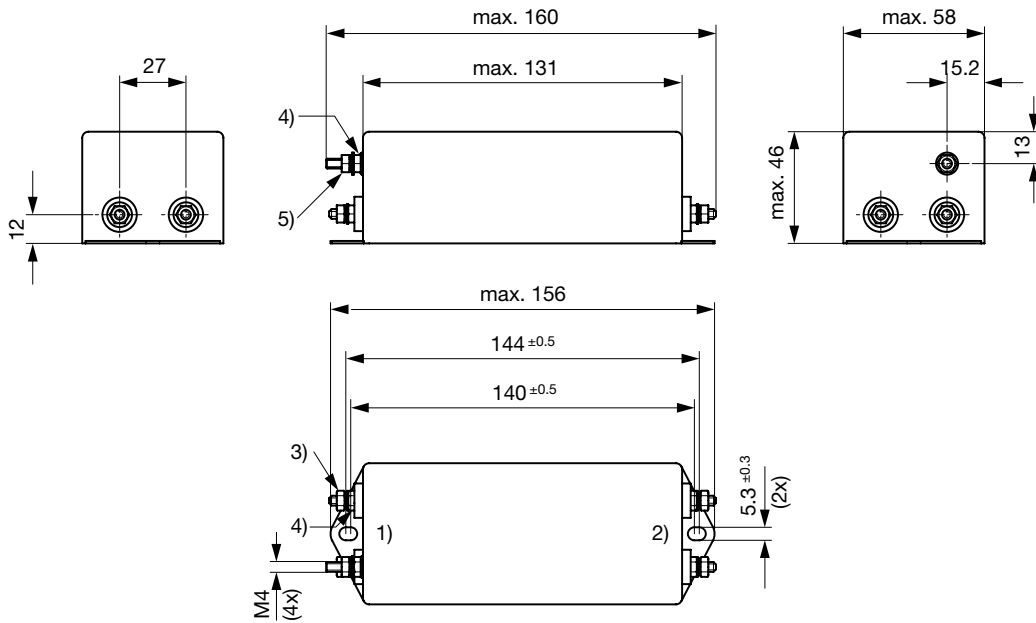

- 1) Line
- 2) Load
- 3) Nut torque 0.8...1 Nm, keep lock-nut fastened
- 4) Lock-nut do not unscrew
- 5) PE; M4x16; 1.2...1.5 Nm, keep lock-nut fastened

Case MC with quick connect terminals

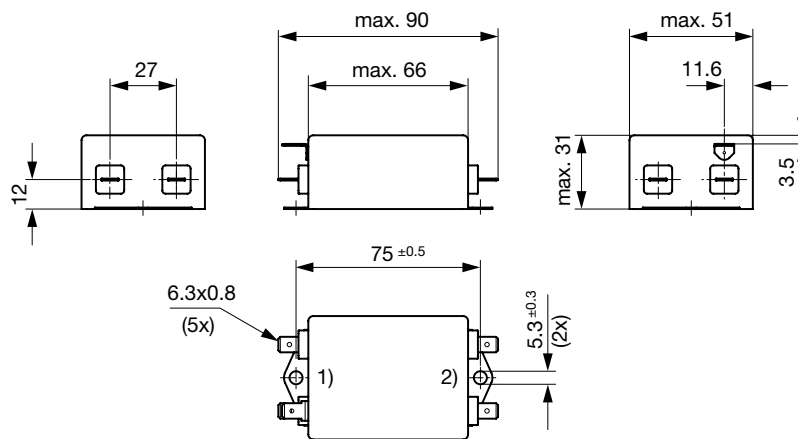

- 1) Line
- 2) Load

Case MD with quick connect terminals

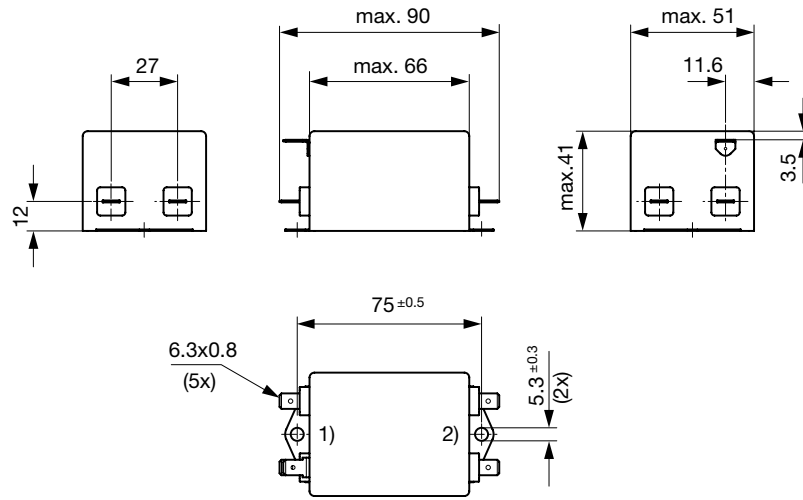

- 1) Line
- 2) Load

Case ME with quick connect terminals

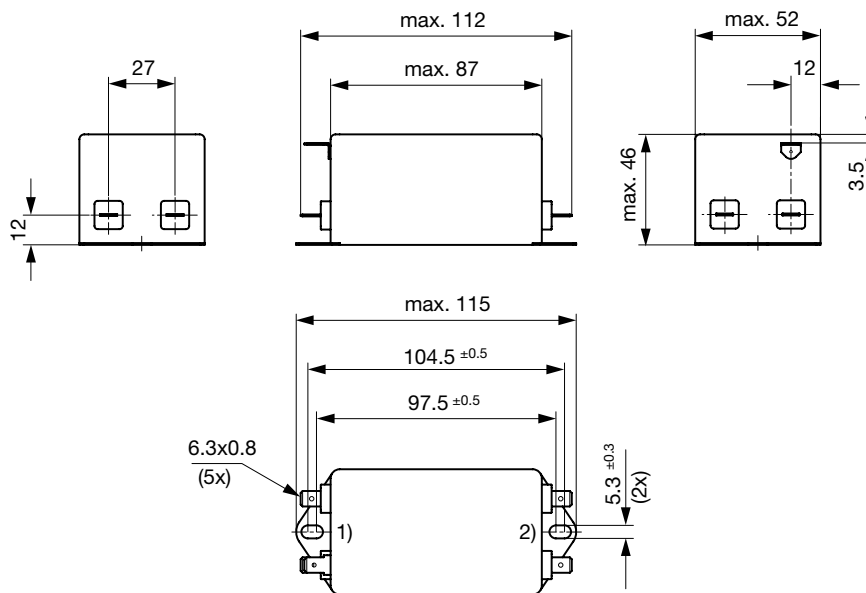

- 1) Line
- 2) Load

Case MF with quick connect terminals

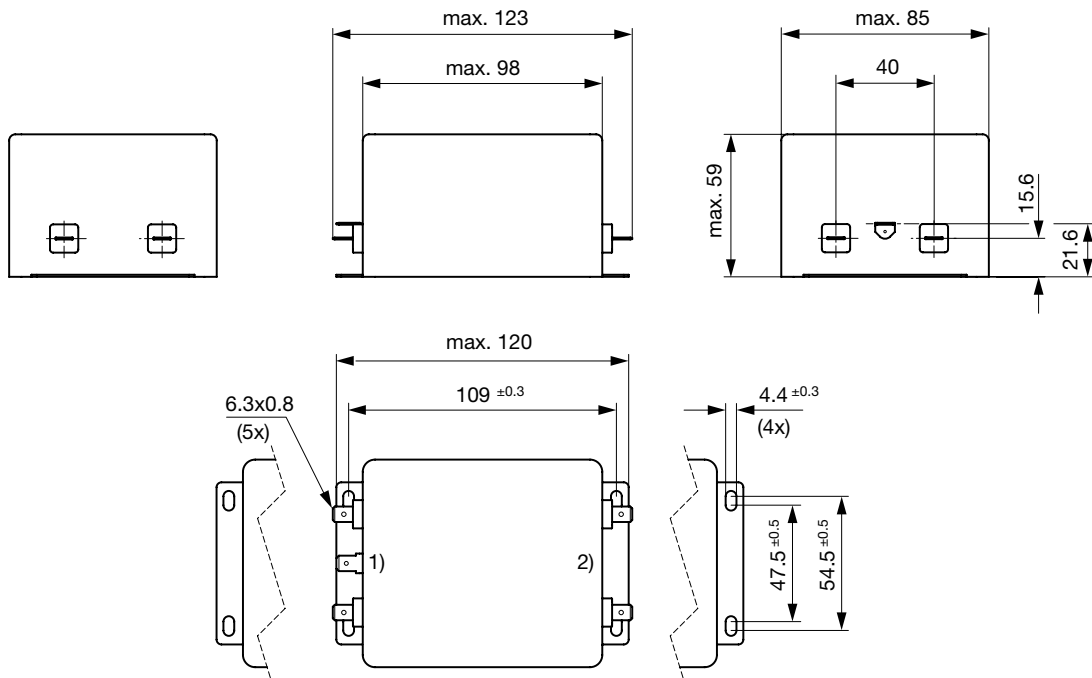

- 1) Line
- 2) Load

Case MF with bolt and nut M4

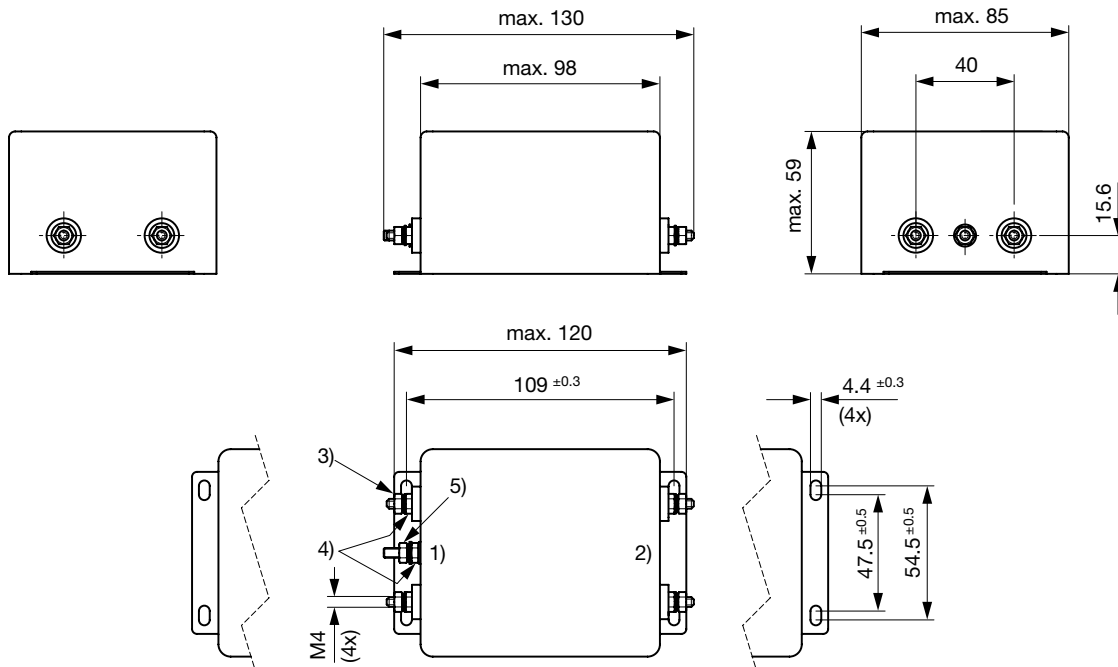

- 1) Line
- 2) Load
- 3) Nut torque 0.8...1 Nm, keep lock-nut fastened
- 4) Lock-nut do not unscrew
- 5) PE; M4x16; 1.2...1.5 Nm, keep lock-nut fastened

Case with wire leads

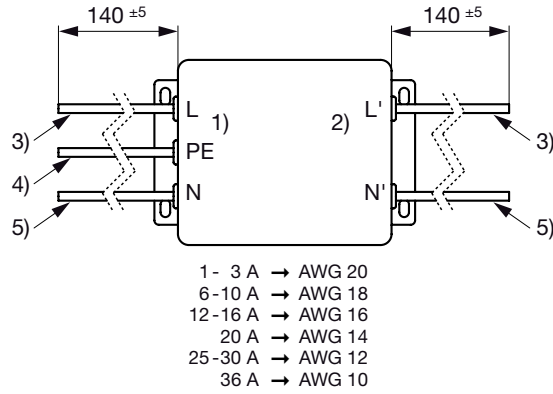

- 1) Line
- 2) Load
- 3) Brown
- 4) Yellow-Green
- 5) Blue

Diagrams

Design C and D

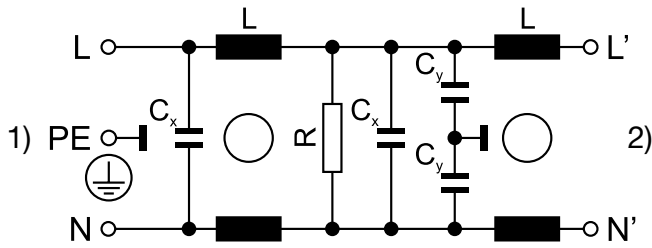

Design F

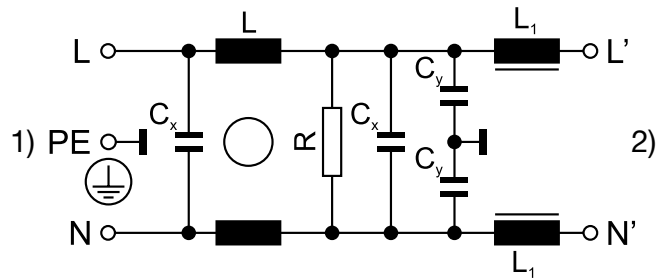

- 1) Line, 2) Load
- Bleeding resistor $R = 1\text{ M}\Omega$
- Medical (M5) without Cy

Attenuation Loss 0.1/100Ω differential mode 100/0.1Ω differential mode - - - - differential mode ____ common mode
 Standard version

1 A / Design C

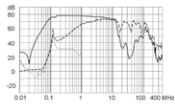

3 A / Design C

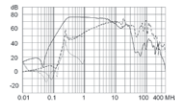

6 A / Design C

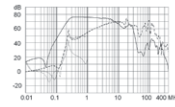

10 A / Design C

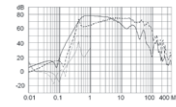

12 A / Design C

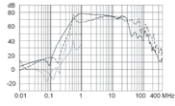

16 A / Design C

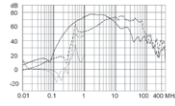

20 A / Design C

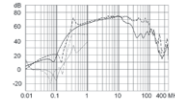

30 A / Design C

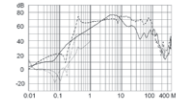

1 A / Design D

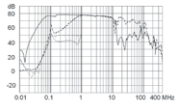

3 A / Design D

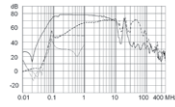

6 A / Design D

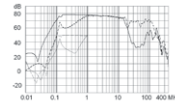

10 A / Design D

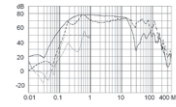

12 A / Design D

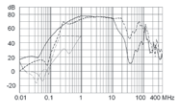

16 A / Design D

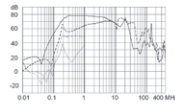

25 A / Design D

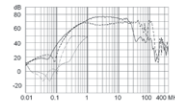

36 A / Design D

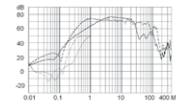

1 A / Design F

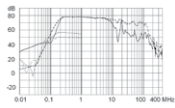

3 A / Design F

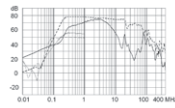

6 A / Design F

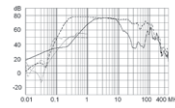

10 A / Design F

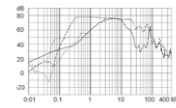

12 A / Design F

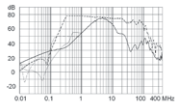

16 A / Design F

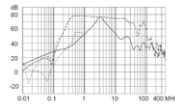

Medical version (M5)

1 A / Design C

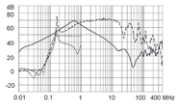

3 A / Design C

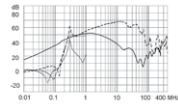

6 A / Design C

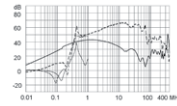

10 A / Design C

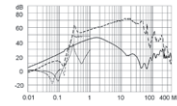

12 A / Design C

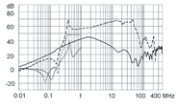

16 A / Design C

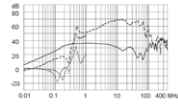

20 A / Design C

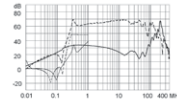

30 A / Design C

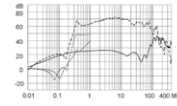

1 A / Design D

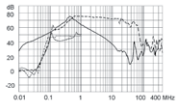

3 A / Design D

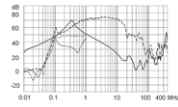

6 A / Design D

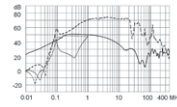

10 A / Design D

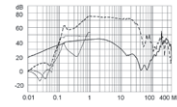

12 A / Design D

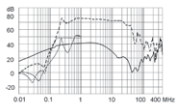

16 A / Design D

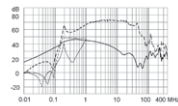

25 A / Design D

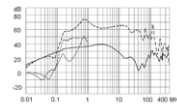

36 A / Design D

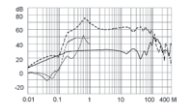

1 A / Design F

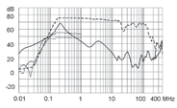

3 A / Design F

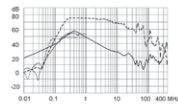

6 A / Design F

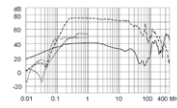

10 A / Design F

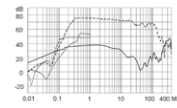

12 A / Design F

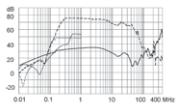

16 A / Design F

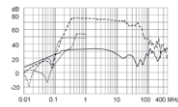

Medical version (M80)

1 A / Design C

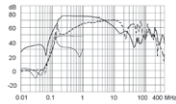

3 A / Design C

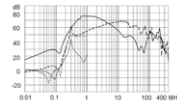

6 A / Design C

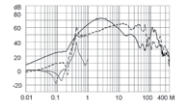

10 A / Design C

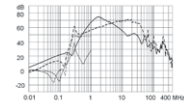

12 A / Design C

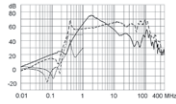

16 A / Design C

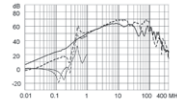

20 A / Design C

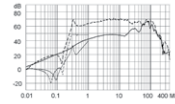

30 A / Design C

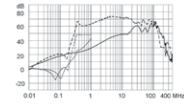

1 A / Design D

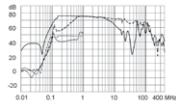

3 A / Design D

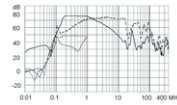

6 A / Design D

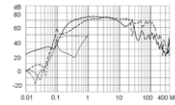

10 A / Design D

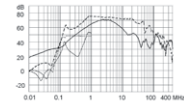

12 A / Design D

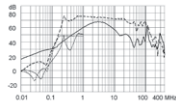

16 A / Design D

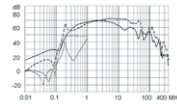

25 A / Design D

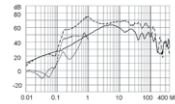

36 A / Design D

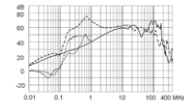

1 A / Design F

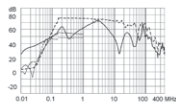

3 A / Design F

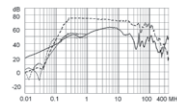

6 A / Design F

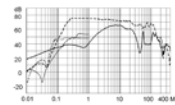

10 A / Design F

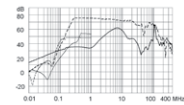

12 A / Design F

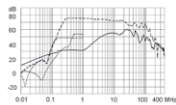

16 A / Design F

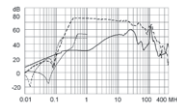

All Variants

Rated current	Filter-Type	Terminal	Design	L	L1	Cx	Cy	Ri	Power Loss	Weight	Housing	Packaging	Order Number
[A]				[mH]	[mH]	[µF]	[nF]	[mΩ]	[W]	[g]		[ST]	
1	Standard	Quick connect terminal 6.3 x 0.8 mm	C	12	-	0.22	4.7	945	1.9	125 g	09	10	5500.2600.01
3	Standard	Quick connect terminal 6.3 x 0.8 mm	C	2.5	-	0.22	4.7	120	2.2	130 g	09	10	5500.2601.01
6	Standard	Quick connect terminal 6.3 x 0.8 mm	C	0.97	-	0.22	4.7	26.2	1.9	130 g	09	10	5500.2602.01
10	Standard	Quick connect terminal 6.3 x 0.8 mm	C	0.8	-	0.47	4.7	12.9	2.6	200 g	MC	10	5500.2603.01
12	Standard	Quick connect terminal 6.3 x 0.8 mm	C	0.58	-	0.47	4.7	10.1	2.9	200 g	MC	10	5500.2604.01
16	Standard	Quick connect terminal 6.3 x 0.8 mm	C	0.65	-	0.33	4.7	8	4.1	265 g	MD	10	5500.2605.01
20	Standard	Quick connect terminal 6.3 x 0.8 mm	C	0.6	-	1	4.7	4.6	3.7	390 g	ME	5	5500.2606.01
30	Standard	Bolt and nut M4	C	0.6	-	1	10	2.5	4.5	855 g	MF	3	5500.2607.03
1	Standard	Quick connect terminal 6.3 x 0.8 mm	D	22	-	0.33	4.7	1320	2.7	165 g	MC	10	5500.2610.01
3	Standard	Quick connect terminal 6.3 x 0.8 mm	D	9.8	-	0.47	4.7	226	4.1	225 g	MD	10	5500.2611.01
6	Standard	Quick connect terminal 6.3 x 0.8 mm	D	7.8	-	1	4.7	55.4	4	350 g	ME	5	5500.2612.01
10	Standard	Quick connect terminal 6.3 x 0.8 mm	D	4.5	-	1	4.7	23.6	4.7	625 g	MB	4	5500.2613.01
12	Standard	Quick connect terminal 6.3 x 0.8 mm	D	3.25	-	1	4.7	16	4.6	630 g	MB	4	5500.2614.01
16	Standard	Quick connect terminal 6.3 x 0.8 mm	D	2.8	-	1	4.7	10.9	5.6	826 g	MF	3	5500.2615.01
25	Standard	Bolt and nut M4	D	2.0	-	2.2	4.7	4.8	6	830 g	MB	4	5500.2616.03
36	Standard	Bolt and nut M4	D	1.23	-	2.2	4.7	3.3	8.5	810 g	MB	4	5500.2617.03
1	Standard	Quick connect terminal 6.3 x 0.8 mm	F	22	0.49	0.33	4.7	1200	2.4	180 g	MC	10	5500.2620.01

Rated current	Filter-Type	Terminal	Design	L	L1	Cx	Cy	Ri	Power Loss	Weight	Housing	Packaging	Order Number
[A]				[mH]	[mH]	[µF]	[nF]	[mΩ]	[W]	[g]		[ST]	
3	Standard	Quick connect terminal 6.3 x 0.8 mm	F	9.8	0.16	0.47	4.7	194	3.5	240g	MD	10	5500.2621.01
6	Standard	Quick connect terminal 6.3 x 0.8 mm	F	7.8	0.11	1	4.7	60	4.3	400g	ME	5	5500.2622.01
10	Standard	Quick connect terminal 6.3 x 0.8 mm	F	4.5	0.06	1	4.7	21	4.2	645g	MB	4	5500.2623.01
12	Standard	Quick connect terminal 6.3 x 0.8 mm	F	3.25	0.05	1	4.7	14.6	4.2	695g	MB	4	5500.2624.01
16	Standard	Quick connect terminal 6.3 x 0.8 mm	F	2.8	0.043	1	4.7	13.7	7	950g	MF	3	5500.2625.01
1	Medical (M5)	Quick connect terminal 6.3 x 0.8 mm	C	12	-	0.22	-	945	1.9	125g	09	10	5500.2600.04
3	Medical (M5)	Quick connect terminal 6.3 x 0.8 mm	C	2.5	-	0.22	-	120	2.2	130g	09	10	5500.2601.04
6	Medical (M5)	Quick connect terminal 6.3 x 0.8 mm	C	0.97	-	0.22	-	26.2	1.9	130g	09	10	5500.2602.04
10	Medical (M5)	Quick connect terminal 6.3 x 0.8 mm	C	0.8	-	0.47	-	12.9	2.6	200g	MC	10	5500.2603.04
12	Medical (M5)	Quick connect terminal 6.3 x 0.8 mm	C	0.58	-	0.47	-	10.1	2.9	200g	MC	10	5500.2604.04
16	Medical (M5)	Quick connect terminal 6.3 x 0.8 mm	C	0.65	-	0.33	-	8	4.1	265g	MD	10	5500.2605.04
20	Medical (M5)	Quick connect terminal 6.3 x 0.8 mm	C	0.6	-	1	-	4.6	3.7	390g	ME	5	5500.2606.04
30	Medical (M5)	Bolt and nut M4	C	0.6	-	1	-	2.5	4.5	855g	MF	3	5500.2607.06
1	Medical (M5)	Quick connect terminal 6.3 x 0.8 mm	D	22	-	0.33	-	1320	2.7	165g	MC	10	5500.2610.04
3	Medical (M5)	Quick connect terminal 6.3 x 0.8 mm	D	9.8	-	0.47	-	226	4.1	225g	MD	10	5500.2611.04
6	Medical (M5)	Quick connect terminal 6.3 x 0.8 mm	D	7.8	-	1	-	55.4	4	350g	ME	5	5500.2612.04
10	Medical (M5)	Quick connect terminal 6.3 x 0.8 mm	D	4.5	-	1	-	23.6	4.7	625g	MB	4	5500.2613.04
12	Medical (M5)	Quick connect terminal 6.3 x 0.8 mm	D	3.25	-	1	-	16	4.6	630g	MB	4	5500.2614.04
16	Medical (M5)	Quick connect terminal 6.3 x 0.8 mm	D	2.8	-	1	-	10.9	5.6	826g	MF	3	5500.2615.04
25	Medical (M5)	Bolt and nut M4	D	2.0	-	2.2	-	4.8	6	830g	MB	4	5500.2616.06
36	Medical (M5)	Bolt and nut M4	D	1.23	-	2.2	-	3.3	8.5	810g	MB	4	5500.2617.06
1	Medical (M5)	Quick connect terminal 6.3 x 0.8 mm	F	22	0.49	0.33	-	1200	2.4	180g	MC	10	5500.2620.04
3	Medical (M5)	Quick connect terminal 6.3 x 0.8 mm	F	9.8	0.16	0.47	-	194	3.5	240g	MD	10	5500.2621.04
6	Medical (M5)	Quick connect terminal 6.3 x 0.8 mm	F	7.8	0.11	1	-	60	4.3	400g	ME	5	5500.2622.04
10	Medical (M5)	Quick connect terminal 6.3 x 0.8 mm	F	4.5	0.06	1	-	21	4.2	645g	MB	4	5500.2623.04
12	Medical (M5)	Quick connect terminal 6.3 x 0.8 mm	F	3.25	0.05	1	-	14.6	4.2	695g	MB	4	5500.2624.04
16	Medical (M5)	Quick connect terminal 6.3 x 0.8 mm	F	2.8	0.043	1	-	13.7	7	950g	MF	3	5500.2625.04
1	Medical (M80)	Quick connect terminal 6.3 x 0.8 mm	C	12	-	0.22	0.47	945	1.9	125g	09	10	5500.2600.07
3	Medical (M80)	Quick connect terminal 6.3 x 0.8 mm	C	2.5	-	0.22	0.47	120	2.2	130g	09	10	5500.2601.07
6	Medical (M80)	Quick connect terminal 6.3 x 0.8 mm	C	0.97	-	0.22	0.47	26.2	1.9	130g	09	10	5500.2602.07
10	Medical (M80)	Quick connect terminal 6.3 x 0.8 mm	C	0.8	-	0.47	0.47	12.9	2.6	200g	MC	10	5500.2603.07
12	Medical (M80)	Quick connect terminal 6.3 x 0.8 mm	C	0.58	-	0.47	0.47	10.1	2.9	200g	MC	10	5500.2604.07
16	Medical (M80)	Quick connect terminal 6.3 x 0.8 mm	C	0.65	-	0.33	0.47	8	4.1	265g	MD	10	5500.2605.07
20	Medical (M80)	Quick connect terminal 6.3 x 0.8 mm	C	0.6	-	1	0.47	4.6	3.7	390g	ME	5	5500.2606.07
30	Medical (M80)	Bolt and nut M4	C	0.6	-	1	0.47	2.5	4.5	855g	MF	3	5500.2607.09
1	Medical (M80)	Quick connect terminal 6.3 x 0.8 mm	D	22	-	0.33	0.47	1320	2.7	165g	MC	10	5500.2610.07
3	Medical (M80)	Quick connect terminal 6.3 x 0.8 mm	D	9.8	-	0.47	0.47	226	4.1	225g	MD	10	5500.2611.07
6	Medical (M80)	Quick connect terminal 6.3 x 0.8 mm	D	7.8	-	1	0.47	55.4	4	350g	ME	5	5500.2612.07
10	Medical (M80)	Quick connect terminal 6.3 x 0.8 mm	D	4.5	-	1	0.47	23.6	4.7	625g	MB	4	5500.2613.07
12	Medical (M80)	Quick connect terminal 6.3 x 0.8 mm	D	3.25	-	1	0.47	16	4.6	630g	MB	4	5500.2614.07
16	Medical (M80)	Quick connect terminal 6.3 x 0.8 mm	D	2.8	-	1	0.47	10.9	5.6	826g	MF	3	5500.2615.07
25	Medical (M80)	Bolt and nut M4	D	2.0	-	2.2	0.47	4.8	6	830g	MB	4	5500.2616.09
36	Medical (M80)	Bolt and nut M4	D	1.23	-	2.2	0.47	3.3	8.5	810g	MB	4	5500.2617.09
1	Medical (M80)	Quick connect terminal 6.3 x 0.8 mm	F	22	0.49	0.33	0.47	1200	2.4	180g	MC	10	5500.2620.07
3	Medical (M80)	Quick connect terminal 6.3 x 0.8 mm	F	9.8	0.16	0.47	0.47	194	3.5	240g	MD	10	5500.2621.07
6	Medical (M80)	Quick connect terminal 6.3 x 0.8 mm	F	7.8	0.11	1	0.47	60	4.3	400g	ME	5	5500.2622.07
10	Medical (M80)	Quick connect terminal 6.3 x 0.8 mm	F	4.5	0.06	1	0.47	21	4.2	645g	MB	4	5500.2623.07
12	Medical (M80)	Quick connect terminal 6.3 x 0.8 mm	F	3.25	0.05	1	0.47	14.6	4.2	695g	MB	4	5500.2624.07
16	Medical (M80)	Quick connect terminal 6.3 x 0.8 mm	F	2.8	0.043	1	0.47	13.7	7	950g	MF	3	5500.2625.07

Most Popular.

Availability for all products can be searched real-time: <http://www.schurter.com/en/Stock-Check/Stock-Check-SCHURTER>

Design C) high symmetrical and asymmetrical noise attenuation

