

JUMO GmbH & Co. KG
 Delivery address: Mackenrodtstraße 14
 36039 Fulda, Germany
 Postal address: 36035 Fulda, Germany
 Phone: +49 661 6003-0
 Fax: +49 661 6003-607
 E-mail: mail@jumo.net
 Internet: www.jumo.net

JUMO Instrument Co. Ltd.
 JUMO House
 Temple Bank, Riverway
 Harlow, Essex CM20 2DY, UK
 Phone: +44 1279 635533
 Fax: +44 1279 635262
 E-mail: sales@jumo.co.uk
 Internet: www.jumo.co.uk

JUMO Process Control, Inc.
 6733 Myers Road
 East Syracuse, NY 13057, USA
 Phone: 315-437-5866
 1-800-554-5866
 Fax: 315-437-5860
 E-mail: info.us@jumo.net
 Internet: www.jumousa.com



JUMO LOGOSCREEN nt

Paperless recorder with TFT display, Ethernet and USB interfaces

Brief description

The LOGOSCREEN nt represents a new generation of paperless recorders from JUMO that stand out through their modular design for the acquisition of measurement data (3 to 18 measurement inputs can be implemented internally), their innovative operating concept and high standards of security to prevent unauthorized access and manipulation of the stored data.

In the LOGOSCREEN nt, data can be visualized in process images as measurement curves, as a bar graph or in alphanumeric form.

Powerful PC programs are available for analyzing and evaluating the archived data, and for configuring the LOGOSCREEN nt.



Type 706581/...

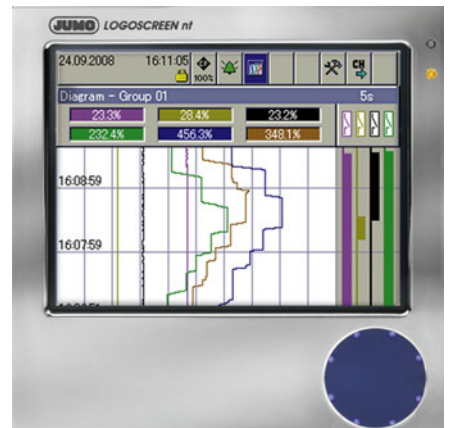

Type 706581/...,443(444)
(Stainless steel front)

Block structure

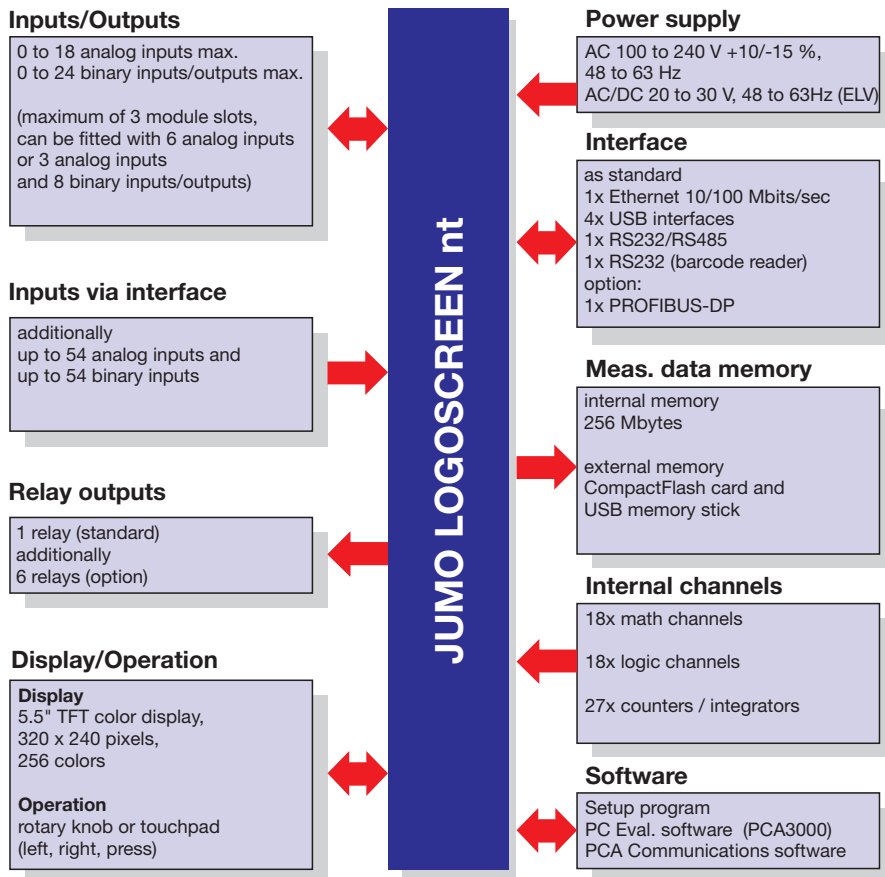

Key features

- Easy operation by control knob or touchpad
- Measurement data storage on CompactFlash memory card or USB memory stick
- Automatic read-out of data through the PCA Communications Software (PCC)
- Interface to SCADA systems, to PLC controls and PC systems
- Integrated web server
- Simultaneous recording of up to 3 batch reports
- Batch control (start, stop, texts) through barcode reader
- Modbus master function
- ATEX approval with stainless steel front

II 2G Ex pxb IIC Gb
 II 2D Ex pxb IIIC Db

- AMS2750/CQI-9 (extra code)

Approvals/marks of conformity (see Technical data)



Technical data

Analog inputs

Thermocouple

Designation	Type	Standard	Meas. range	Accuracy ^a
Fe-CuNi	L	DIN 43 710	-200 to +900°C	±0.1%
Fe-CuNi	J	EN 60 584	-200 to +1200°C	±0.1% from -100°C
Cu-CuNi	U	DIN 43 710	-200 to +600°C	±0.1% from -150°C
Cu-CuNi	T	EN 60 584	-270 to +400°C	±0.1% from -150°C
NiCr-Ni	K	EN 60 584	-200 to +1372°C	±0.1% from -80°C
NiCr-CuNi	E	EN 60 584	-200 to +1000°C	±0.1% from -80°C
NiCrSi-NiSi	N	EN 60 584	-100 to +1300°C	±0.1% from -80°C
Pt10Rh-Pt	S	EN 60 584	0 to 1768°C	±0.15%
Pt13Rh-Pt	R	EN 60 584	0 to 1768°C	±0.15%
Pt30Rh-Pt6Rh	B	EN 60 584	0 to 1820°C	±0.15% from 400°C
W3Re/W25Re	D		0 to 2495°C	±0.15% from 500°C
W5Re/W26Re	C		0 to 2320°C	±0.15% from 500°C
W3Re/W26Re			0 to 2400°C	±0.15% from 500°C
Chromel-copel		GOST R 8.585-2001	-200 to +800°C	±0.15% from -80°C
Chromel-alumel		GOST R 8.585-2001	-200 to +1372°C	±0.1% from -80°C
PLII (Platinel II)			0 to 1395°C	±0.15%
Shortest span	Type L, J, U, T, K, E, N, chromel-alumel, PLII: 100°C Type S, R, B, D, C, W3Re/W26Re, chromel-copel: 500°C			
Range start/end	freely programmable within the limits, in 0.1°C steps			
Cold junction	Pt100 internal or thermostat external constant			
Cold junction accuracy (internal)	± 1°C			
Cold junction temperature (external)	-50 to +150°C adjustable			
Sampling cycle	Channel 1 - 18: 125ms in total			
Input filter	2nd order digital filter; filter constant adjustable from 0 to 10.0 sec			
Electrical isolation	see "Electrical data" on page 5 and "Overview of the electrical isolation" on page 19			
Resolution	dynamic resolution up to 16 bit			
Features	also programmable in °F			

^a The linearization accuracy refers to the maximum measuring range. The linearization accuracy is reduced with short spans.

Resistance thermometer

Designation	Standard	Connection circuit	Meas. range	Accuracy ^a	Meas. curr.
Pt100	EN 60 751 (TC = 3.85*10 ⁻³ 1/°C)	2/3-wire	-200 to +100°C	±0.5°C	≈ 250µA
		2/3-wire	-200 to +850°C	±0.8°C	≈ 250µA
		4-wire	-200 to +850°C	±0.5°C	≈ 250µA
Pt100	JIS 1604 (TC = 3.917*10 ⁻³ 1/°C)	2/3-wire	-200 to +100°C	±0.5°C	≈ 250µA
		2/3-wire	-200 to +650°C	±0.8°C	≈ 250µA
		4-wire	-200 to +650°C	±0.5°C	≈ 250µA
Pt100	GOST 6651-94 A.1 (TC = 3.91*10 ⁻³ 1/°C)	2/3-wire, 4-wire	-200 to +100°C	±0.5°C	≈ 250µA
		2/3-wire, 4-wire	-200 to +850°C	±0.8°C	≈ 250µA
Pt500	EN 60 751 (TC = 3.85*10 ⁻³ 1/°C)	2/3-wire, 4-wire	-200 to +100°C	±0.5°C	≈ 100µA
		2/3-wire, 4-wire	-200 to +850°C	±0.9°C	≈ 100µA
Pt1000	EN 60 751 (TC = 3.85*10 ⁻³ 1/°C)	2/3-wire	-200 to +100°C	±0.5°C	≈ 100µA
		2/3-wire	-200 to +850°C	±0.8°C	≈ 100µA
		4-wire	-200 to +850°C	±0.5°C	≈ 100µA
Ni 100	DIN 43 760 (TC = 6.18*10 ⁻³ 1/°C)	2/3-wire, 4-wire	-60 to +180°C	±0.4°C	≈ 250µA
Pt50	ST RGW 1057 1985 (TC = 3.91*10 ⁻³ 1/°C)	2/3-wire	-200 to +100°C	±0.5°C	≈ 250µA
		2/3-wire	-200 to +1100°C	±0.9°C	≈ 250µA
		4-wire	-200 to +100°C	±0.5°C	≈ 250µA
		4-wire	-200 to +1100°C	±0.6°C	≈ 250µA
Cu 50	(TC = 4.26*10 ⁻³ 1/°C)	2/3-wire	-50 to +100°C	±0.5°C	≈ 250µA
		2/3-wire	-50 to +200°C	±0.9°C	≈ 250µA
		4-wire	-50 to +100°C	±0.5°C	≈ 250µA
		4-wire	-50 to +200°C	±0.7°C	≈ 250µA

Designation	Standard	Connection circuit	Meas. range	Accuracy ^a	Meas. curr.
Cu 100	GOST 6651-94 A.4 (TC = 4.26·10 ⁻³ 1/°C)	2/3-wire	-50 to +100°C	±0.5°C	≈ 250µA
		2/3-wire	-50 to +200°C	±0.9°C	≈ 250µA
		4-wire	-50 to +100°C	±0.5°C	≈ 250µA
		4-wire	-50 to +200°C	±0.6°C	≈ 250µA
Connection circuit		2-, 3-, or 4-wire circuit			
Shortest span		15°C			
Sensor lead resistance		max. 30 per conductor for 3-wire/4-wire circuit max. 10 per conductor for 2-wire circuit			
Range start/end		freely programmable within the limits, in 0.1°C steps			
Sampling cycle		Channel 1 - 18: 125ms in total			
Input filter		2nd order digital filter; filter constant adjustable from 0 to 10 sec			
Electrical isolation		see "Electrical data" on page 5 and "Overview of the electrical isolation" on page 19			
Resolution		dynamic resolution up to 16 bit			
Features		also programmable in °F			

^a The linearization accuracy refers to the maximum measuring range. The linearization accuracy is reduced with short spans.

Resistance transmitter and potentiometer

Designation	Meas. range	Accuracy ^a	Meas. curr.
Resistance transmitter	up to 4000Ω	±4Ω	≈ 100µA
Potentiometer	< 400Ω	±400mΩ	≈ 250µA
	≥ 400Ω to 4000Ω	±4Ω	≈ 100µA
Connection circuit		resistance transmitter: 3-wire circuit potentiometer: 2-/3-/4-wire circuit	
Shortest span		60Ω	
Sensor lead resistance		max. 30 per conductor for 4-wire circuit max. 10 per conductor for 2-/3-wire circuit	
Resistance values		freely programmable within the limits, in 0.1 steps	
Sampling cycle		Channel 1 - 18: 125ms in total	
Input filter		2nd order digital filter; filter constant adjustable from 0 to 10.0 sec	
Electrical isolation		see "Electrical data" on page 5 and "Overview of the electrical isolation" on page 19	
Resolution		dynamic resolution up to 16 bit	

^a The linearization accuracy refers to the maximum measuring range. The linearization accuracy is reduced with short spans.

Input for DC voltage, DC current

Basic range	Accuracy ^a	Input resistance
-12 to +112mV	±100µV	R _E ≥ 1 MΩ
-10 to +210mV	±240µV	R _E ≥ 470 kΩ
-1.5 to +11.5V	±6mV	R _E ≥ 470 kΩ
-0.12 to +1.12V	±1 mV	R _E ≥ 470 kΩ
-1.2 to +1.2V	±2mV	R _E ≥ 470 kΩ
-11.2 to +11.2V	±12mV	R _E ≥ 470 kΩ
Shortest span		5mV
Range start/end		freely programmable within the limits in 0.01 mV steps
-1.3 to +22mA	±20µA	burden voltage ≤ 3V
-22 to +22mA	±44µA	
Shortest span		0.5mA
Range start/end		freely programmable within the limits in 0.01 mA steps
Overrange/underrange		according to NAMUR NE 43
Sampling cycle		Channel 1 - 18: 125ms in total
Input filter		2nd order digital filter; filter constant adjustable from 0 to 10.0 sec
Electrical isolation		see "Electrical data" on page 5 and "Overview of the electrical isolation" on page 19
Resolution		dynamic resolution up to 16 bit

^a The linearization accuracy refers to the maximum measuring range. The linearization accuracy is reduced with short spans.

Transducer short circuit/break

	Short-circuit ^a	Break ^a
Thermocouple	not detected	detected
Resistance thermometer	detected	detected
Resistance transmitter	not detected	detected
Potentiometer	not detected	detected
Voltage ≤ ± 210mV	not detected	detected
Voltage > ± 210mV	not detected	not detected
Current	not detected	not detected

^a Programmable reaction of device, e.g. triggering alarm

Binary inputs/outputs (option)

Input or output	configurable as input or output
Number	8, 16 or 24, depending on the device version, to DIN VDE 0411, Part 500; max. 25Hz, max. 32V
Input <ul style="list-style-type: none"> level counting frequency 	logic "0": -3 to +5V (input current max. ±1 mA), logic "1": 12 to 30V (2.5mA ≤ input current ≤ 5mA) 8Hz
High-speed input <ul style="list-style-type: none"> task counting frequency 	the first two binary inputs of each module (B1, B2, B9, B10, B17, B18), if the module is not fitted with relays or 6 analog inputs count function, e.g. for flow measurement 10kHz
Output <ul style="list-style-type: none"> type level sampling cycle 	open-collector output, switches relative to positive voltage logic "0": transistor is inhibited (max. permissible voltage across switching transistor 30V, max. leakage current 0.1 mA) logic "1": transistor is switched on (max. voltage across switching transistor 1.6V, max. current 50 mA) at least 1 sec (1Hz)

Outputs

1 relay (ex-factory)	changeover (SPDT), 3A, 230V AC ^a
6 relays (option)	changeover (SPDT), 3A, 230V AC ^{a,b}

^a With resistive load.

^b It is not permissible to mix SELV circuits and supply circuits.

Interfaces

RS232/RS485 (connector 7) <ul style="list-style-type: none"> protocol baud rate modem connector external inputs 	Qty. 1, switchable between RS232 and RS485 Modbus master, Modbus slave and barcode reader 9600, 19200, 38400 can be connected SUB-D via the Modbus master/slave function, 54 analog and 54 binary
RS232 for barcode reader (connector 2) <ul style="list-style-type: none"> protocol baud rate connector external inputs 	Qty. 1 Modbus master, Modbus slave and barcode reader 9600, 19200, 38400 SUB-D via the Modbus master/slave function, 54 analog and 54 binary
Ethernet (connector 6) <ul style="list-style-type: none"> quantity protocols baud rate connector data format 	max. 1 TCP, IP, HTTP, DHCP, SMTP, ModbusTCP 10Mbits/sec, 100Mbits/sec RJ45 HTML
USB host (connector 5) <ul style="list-style-type: none"> quantity use max. current 	2 (or 1 with stainless steel front), connector 5 and front connector (not with stainless steel front); no parallel operation for connecting a memory stick 100mA

USB device (connector 15) <ul style="list-style-type: none"> • quantity • use 	2 (or 1 with stainless steel front), connector 15 and front connector (not with stainless steel front); no parallel operation for connecting to the (master) computer
PROFIBUS-DP (connector 3) <ul style="list-style-type: none"> • quantity • connector • transfer rate • external inputs 	max. 1 (extra code) SUB-D max. 12 Mbit/s via Profibus slave function, 54 analog and 54 binary

Screen

Resolution / size	320 x 240 pixels / 5.5"
Type / number of colors	TFT color screen / 256 colors
Screen refresh rate	> 150Hz
Brightness setting	adjustable on instrument
Screen saver (switch-off)	through waiting time or control signal
Operation <ul style="list-style-type: none"> • die-cast zinc front • stainless steel front (extra code) 	via control knob via capacitive touchpad Caution: Do not use the touchpad with damp/wet fingers to avoid condensation.

Electrical data

Supply voltage (switch-mode PSU)	100 - 240V AC +10/-15%, 48 - 63Hz or 20 - 30V AC/DC, 48 - 63Hz (ELV)
Electrical safety Protection class I Test voltages (type test) <ul style="list-style-type: none"> • mains supply circuit to meas. circuit • mains supply circuit to housing (protective conductor) • measuring current circuits to meas. current circuit and housing • electrical isolation between analog inputs 	to EN 61 010, Part 1, July 2011 overvoltage category II, pollution degree 2 terminal for PE conductor with AC supply: 2.3kV/50Hz, 1 min, with AC/DC supply: 2.3kV/50Hz, 1 min, with AC supply: 2.3kV/50Hz, 1 min, with AC/DC supply: 2.3kV/50Hz, 1 min 500V/50Hz, 1 min up to 30V AC and 50V DC
Supply voltage error	< 0.1% of range span
Power consumption	approx. 40VA
Data backup	CompactFlash memory card
Electrical connection <ul style="list-style-type: none"> • mains supply and relays • analog and binary inputs 	at rear through pluggable screw terminals, 5.08mm raster, max. conductor cross-section $\leq 2.5\text{mm}^2$ or $2 \times 1.5\text{mm}^2$ with ferrules at rear through pluggable screw terminals, 3.81mm raster, max. conductor cross-section $\leq 1.5\text{mm}^2$

Environmental influences

Ambient temperature range	0 to +50 °C
Ambient temperature effect	0.03%/°C
Storage temperature range	-20 to +60 °C
Climatic conditions	$\leq 75\%$ relative humidity, no condensation
Site altitude	up to 2000 m above sea level
EMC <ul style="list-style-type: none"> • interference emission • immunity to interference 	EN 61 326-1 Class A - only for industrial use - to industrial requirements

Housing

Housing front	zinc die-casting, optionally in stainless steel (extra code)
Housing type	housing for flush-panel mounting to IEC 61 554, in stainless steel (indoor use)
Bezel size	144mm x 144mm to IEC 61 554
Depth behind panel	193mm (incl. terminals)
Panel cut-out	138 ^{+1.0} mm x 138 ^{+1.0} mm to IEC 61 554
Panel thickness	2 - 40mm
Housing mounting	in panel to DIN 43 834
Operating position	unrestricted, but taking into account the viewing angle of the screen, horizontally ±65°, vertically +40° to -65°
Enclosure protection	to EN 60 529 Category 2, front IP65, rear IP20
Weight	approx. 3.5kg

Approvals/marks of conformity

Mark of conformity	Testing laboratory	Certificates / certification numbers	Test basis	valid for
c UL us	Underwriters Laboratories	E 201387	UL 61010-1 CAN/CSA-C22.2 No. 61010-1	the flush-mounted instrument; not in conjunction with extra code 350
II 2G Ex pxb IIC Gb II 2D Ex pxb IIIC Db	Eurofins Electrosuisse	SEV 08 ATEX 0155 U	EN 60079-0:2012 + A11:2013 EN 60079-2:2014	the flush-mounted instrument; only in conjunction with extra code 443 or 444 and without extra code 350
NEMA 4X	Intertek	4010203	NEMA 250-2008	the flush-mounted instrument; only in conjunction with extra code 443 and without extra code 350



Control knob, to rotate and press.

CompactFlash memory card and USB interfaces behind housing door.

Instrument description

Hardware

The paperless recorder is built to a modular design. The basic type consists of a PSU board (incl. relays) and a CPU board (incl. Ethernet and RS232/RS485 interfaces and an RS232 interface for barcode reader and USB interface connection).

Module slots 1, 2 and 3 can be fitted with input modules, each with 6 analog inputs or 3 analog inputs and 8 binary inputs/outputs. Alternatively, module slot 3 can be fitted with a relay module that has 6 relays. Optionally, the PSU board can be equipped with a PROFIBUS-DP interface.

Data recording

Measurements are acquired continuously in a 125msec sampling cycle. Based on these measurements, reports are compiled and limits checked.

The measurements are transferred to the main memory of the instrument, according to the programmable storage cycle and stored value (maximum, minimum, average, min&max, instantaneous value or economy mode).

The paperless recorder saves the data in groups, and an input can be assigned to several groups (maximum 9).

Main memory (SRAM)

The data stored in the SRAM are regularly copied to the internal memory in 20 kbyte blocks.

Internal memory

When a block in the main memory has been filled, it is copied to the internal memory. The internal memory has a capacity of max. 256 Mbytes.

Every write action is monitored, so that any errors in saving the data can be immediately identified.

The instrument monitors the capacity of the internal memory and activates one of

the "memory alarm" signals when the capacity falls below the configurable residual capacity level. These signals can be used, for instance, to operate the alarm relay.

The memory is written as a ring memory, i. e. when the memory is full, the oldest data are automatically overwritten by the new data.

Data from the internal memory can be shown as a history presentation on the recorder. The size of the history memory can be configured.

Data transfer to the PC

Data transfer from the paperless recorder to a PC is made by means of the external CompactFlash memory card (not available with stainless steel front), the USB memory stick or via one of the interfaces (USB device, RS232, RS485, Ethernet).

Data security

The data are stored in coded form in a proprietary format. This ensures a high level of data security.

If the paperless recorder is disconnected from the supply, then:

- RAM and clock time are buffered by a lithium battery (ex-factory) ≥ 10 years or with a storage capacitor ≥ 2 days (ambient temperature 0 to $+45$ °C),
- measurement and configuration data in the internal memory will not be lost.

Recording duration

Depending on the configuration of the instrument, the duration of the recording can vary over a considerable range (from a few days up to several months).

Report

For each channel of a group, a report (maximum/minimum/average or integrator) can be run over defined periods.

Batch reports

Up to three batch reports can be created simultaneously in the recorder. The measurement data, start, end and duration of each batch can be displayed together with a batch counter and freely definable texts, both on the recorder and within the PC Evaluation Software PCA3000.

On request, a barcode reader can be used to start batches and read in batch texts.

Limit checkline

changeover of operating mode

Over/underlimit conditions trigger alarms. An alarm can be used, for instance, as a control signal for changing over the operating mode.

The storage cycle and stored value can be configured separately for all three operating modes.

With the help of the alarm delay function, brief occurrences or over/underlimit conditions can be filtered out, with the result that no alarm is generated.

Normal operation

If the instrument is **not** in timed or event operation, normal operation is active.

Event operation

Event operation is activated/deactivated by a control signal (binary input, group/combo combination alarm, ...). As long as the control signal is active, the instrument is in event operation.

Timed operation

Timed operation is active on a daily basis within a programmable time period. The operating modes have different priorities.

Counters/integrators

27 additional internal channels are available for use as counters, integrators, operating time counters or for flow measurements.

These counters are controlled through the binary inputs, the alarms, or via the logic channels. The analog channels can be used for the integrators.

The numerical indication is shown in a separate window, with a maximum of 9 digits. The acquisition period can be selected as: periodic, daily, weekly, monthly, yearly as well as external, total (overall count) or daily from ... to.

A maximum of 6 binary inputs are available as high-speed counters with a 10 kHz sampling cycle rate.

Math/logic module (extra code)

The module for math and logic (18 channels each) enables, for instance, the combination of analog channels with one another, and also the combination of analog channels with counters and binary inputs. The operators available for formulae are: +, -, *, /, SQRT(), MIN(), MAX(), SIN(), COS(), TAN(), **, EXP(), ABS(), INT(), FRC(), LOG(), LN(), humidity, moving average or !, &, |, ^, as well as (and).

The math and logic module can only be configured through the setup program.

Time server (SNTP)

The time server function (SNTP = simple network time protocol) enables the synchronization between the time of the paperless recorder with external time signals (server; e.g. atomic clock).



Mobus slave monitoring of external inputs

If active Modbus slave monitoring (timeout monitoring) is the case then the communication (Modbus protocol) between the slave (paperless recorder) and the master with regard to the external analog and binary inputs is monitored. If no communication takes place within the configured time then an alarm message is displayed and entered into the alarm and event list.

Operation and configuration

On the recorder

The instrument is configured from the control knob (or with stainless steel front, from the touchpad) on the front panel under menu guidance.

-  Shift current menu position (cursor) to the left or upwards.
-  Shift current menu position (cursor) to the right or downwards.
-  When the control knob is pressed, the current function is executed.

Example:



 Rotate control knob to the left.



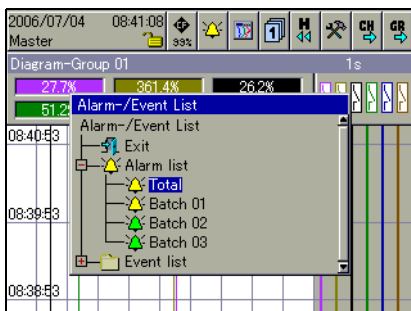

 Press control knob.

Result: The menu for the alarm and event list is called up.

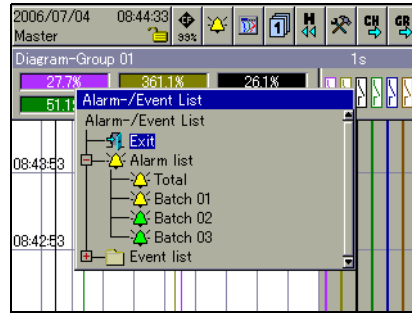

 Rotate control knob to the left.



 Press control knob.

Result: The menu for the alarm and event list is closed again.



 Integrated user lists (different users with different authorizations) protect the recorder against unauthorized access.

Through the setup program

As an alternative to the configuration from the control knob on the recorder, the instrument can also be configured through the setup program.

Communication between the setup program and the paperless recorder is made through the:

- USB device interface,
- serial interface,
- Ethernet interface,
- CompactFlash memory card or
- USB memory stick.

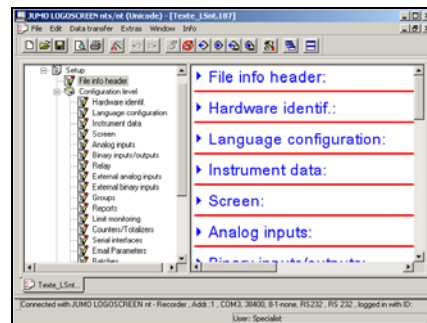

The configuration data can be archived on a data storage medium and output to the printer.

Operating language

Two languages (see order details) are integrated in the instrument ex-factory. The setup program is used to exchange the operator language.

The languages available at the moment are: English, French, German, Russian, Japanese, Chinese, Italian, Romanian, Czech, Hungarian, Polish, Greek, Spanish, and Portuguese.

Other language versions (with Unicode capability) can be created.

Process images (editor)

The setup program can create process images (max. 9; one process image for each group) and transfer them to the paperless recorder for display. Up to 25 objects (images, analog channels, binary channels, texts, ...) can be used in a process image.

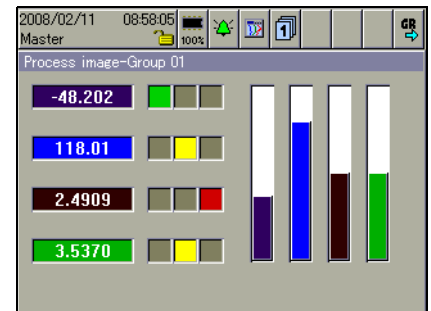

One process image is integrated in the paperless recorder ex-factory.

Visualization on the instrument

Operator level

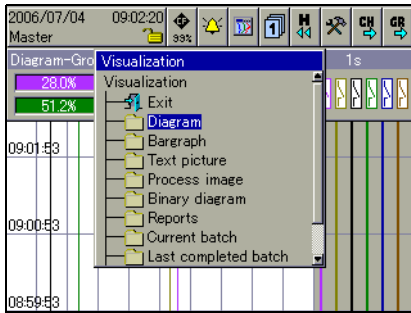

- Selection of visualization

Vertical diagram

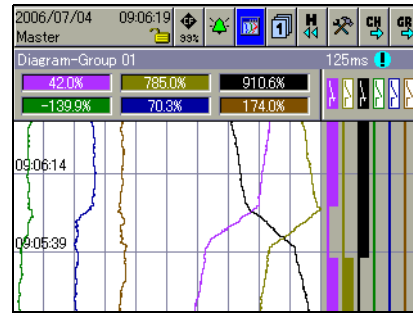

- Recorder chart presentation of analog and binary channels
- Display of scaling and limit markers of a channel (can be switched on/off)
- Numerical display of current analog channels

Horizontal diagram

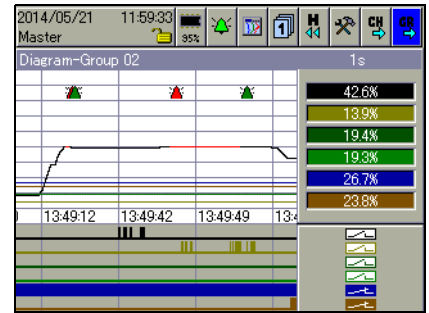

- Functionality corresponds to the vertical appearance
- Visualization without analog signals is also possible (either horizontally or vertically)

Bar graph presentation

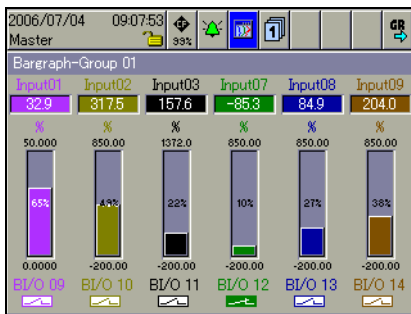

- Bar graph presentation of analog channels
- On/Off presentation of binary channels
- Display of current analog channels with scaling and limit markers
- Color change of bar graph to red when limits are infringed

Numerical presentation

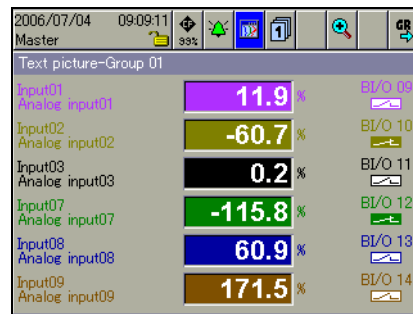

- Large numerical presentation of analog channels, including the channel name and description
- Each analog channel can be switched to the foreground
- On/Off presentation of binary channels

Numerical 1-channel presentation

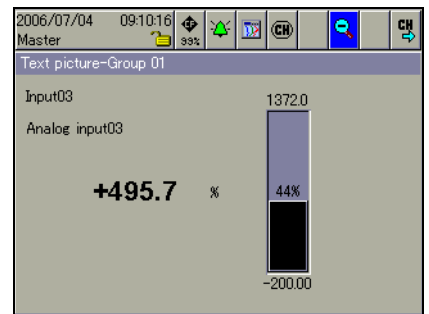

- Clear presentation of an analog channel
- An analog input is shown simultaneously as a bar graph and a number
- Display of channel name and description
- Display of scaling and limit markers

Process image

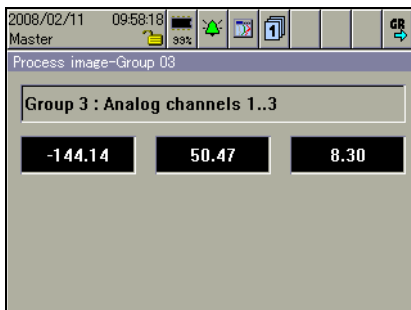

- Freely configurable presentation (through the setup program) of analog and binary signals with background pictures
- One process image for each group

Binary presentation (vertical)

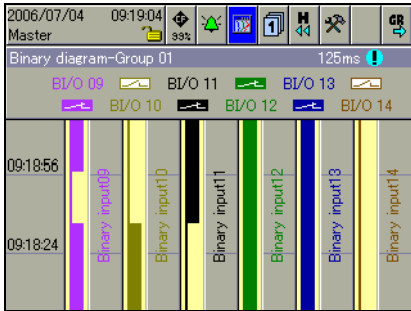

- On/Off presentation of binary channels

Binary presentation (horizontal)

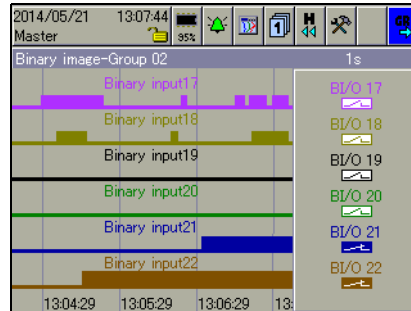

- On/Off presentation of binary channels

Report

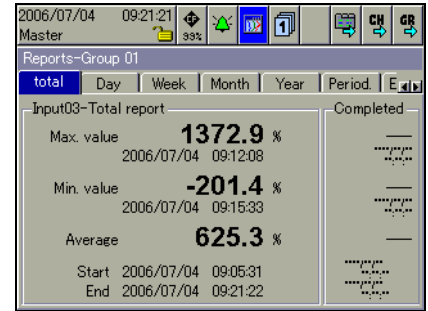

- Display of different reports for the analog channels of a group
- Details of minimum, maximum, average/integral values and time period
- Display of the previous report

Batch reports

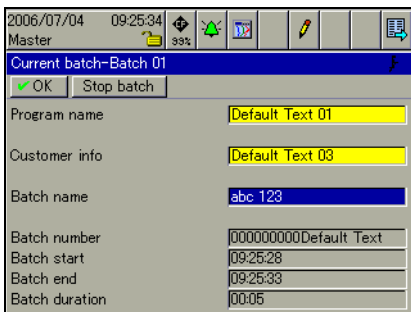

- 3 batches documented simultaneously
- Changeover between current and completed batch reports
- Electronic signature is possible
- Batch texts via interface and barcode reader, among others

Counter/integrator presentation

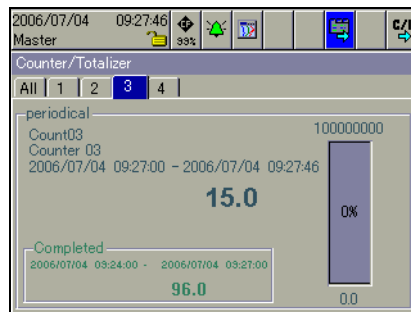

- Presentation of up to 27 counters or integrators
- Changeover between individual and overall display
- Display of the current and the most recently completed count

Group selection

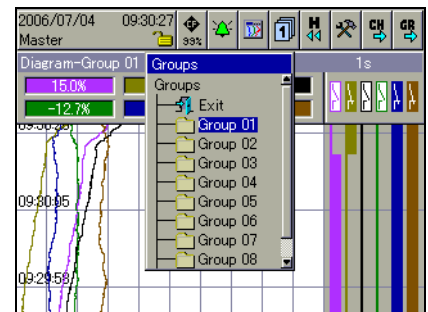

- Up to 9 groups are configurable
- Up to 6 analog and 6 binary channels can be shown for each group
- Measurement signals can be used in several groups

History presentation

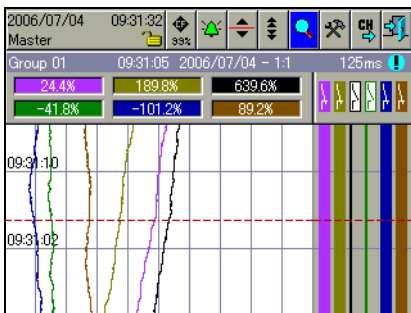

- All stored measurement data are shown as curves at different zoom levels
- Display of scaling and limit markers of a channel
- Numerical display of the measurements of the analog channels at the cursor position
- Shifting of the visible section within the stored measurement data

Presentation of alarm lists

Date	Time	Description
2006/07/04	09:47:22	Alarm Lim02
2006/07/04	09:47:15	Alarm Lim01
2006/07/04	09:47:15	I/O 9 not calibrated
2006/07/04	09:47:15	High Alarm AI08
2006/07/04	09:47:15	I/O 8 not calibrated
2006/07/04	09:47:15	I/O 7 not calibrated
2006/07/04	09:47:15	High Alarm AI02

- Display of current alarms
- For the instrument as a whole or batch-related
- Up to 150 entries visible on the recorder

Presentation of event lists

Date	Time	Description
2006/07/04	09:35:19	CF card removed
2006/07/04	09:35:19	CF card in place
2006/07/04	09:35:16	CF card removed
2006/07/04	09:34:16	POWER ON
2006/07/04	09:33:42	POWER OFF
2006/07/04	09:26:29	Batch 01 end
2006/07/04	09:25:28	Batch 01 start
2006/07/04	09:05:31	NEW CONFIGURATION

- Display and storage of events and alarms
- For the instrument as a whole or batch-related
- Up to 150 entries visible on the recorder

Configuration

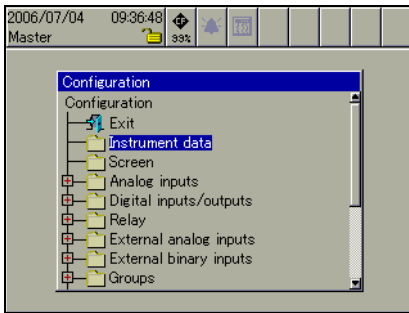

- Configuration on the recorder itself, by rotating and pressing the control knob
- Configuration through the setup program

Visualization through the web server

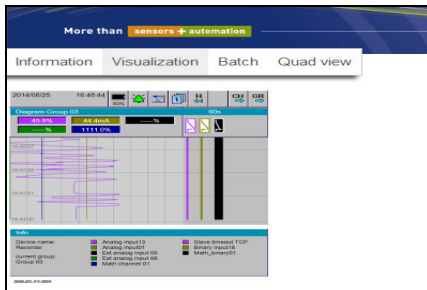

- Online visualization of a recorder
- Selection of customized HTML pages (created upon request)
- Control via latest browser version such as Internet Explorer 11 or above

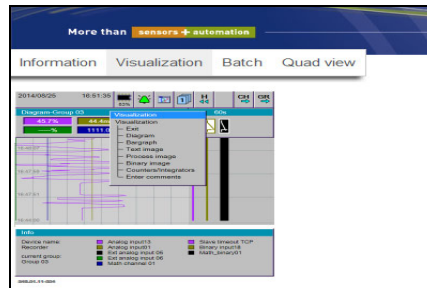

- Navigation through the different recorder visualizations (curves, bar graph, text, process, binary; but no report)
- Active batch protocol available via menu

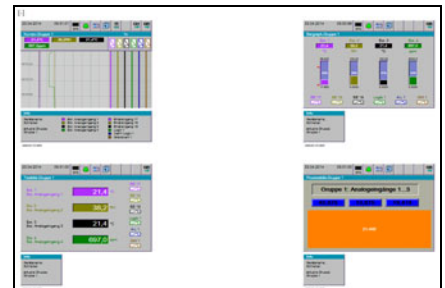

- Max. four recorders or four different visualizations simultaneously

PC programs

PC Evaluation Software (PCA3000)

The PC Evaluation Software (PCA3000) is a program which runs under Microsoft Windows XP, Windows Vista, and Windows 7 (32 bit or 64 bit), and Windows 8 (32 bit or 64 bit), and is used to manage, archive, visualize and evaluate the recorder data.

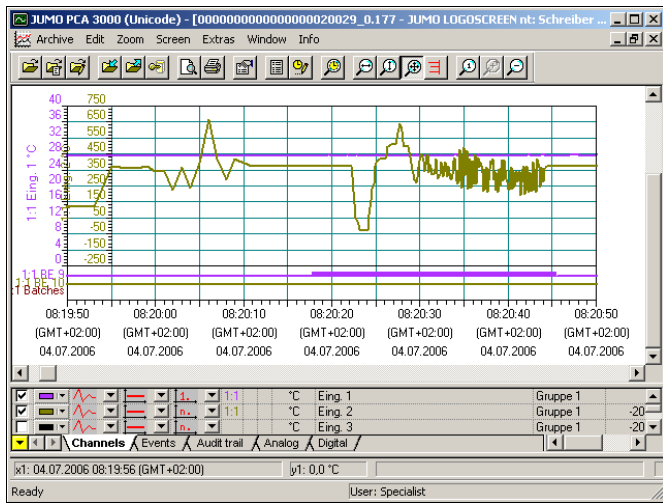

- The data from differently configured instruments are recognized by the PC Evaluation Software and stored in an archive database. All management is fully automatic. The user only has to manually allocate an identifier (supplementary description).
- The user can at any time gain access to certain data sets which can be distinguished by the identifier. It is also possible to restrict the time periods to be evaluated.
- Any analog or binary channels of a paperless recorder (even from different groups) can subsequently be combined into PCA groups in PCA3000.
- Since each group is displayed in a separate window, several groups can be shown simultaneously on the screen and compared.
- Operation by mouse or keys.
- Using the export filter, it is possible to export the stored data, so that they can be processed in other programs such as Excel.
- The PC Evaluation Software PCA3000 has network capability, i.e. several users can obtain data from the same archive file (*.177) in a network directory, independently of each other.

PCA Communications software (PCC)

- Data can be read out from the recorder via the USB device interface, the serial interface (RS232/RS485) or via the Ethernet interface. The data can be read manually or automatically (e.g. daily at 23.00 hrs).
- Data can also be retrieved via remote control, through a modem.

Functional overview

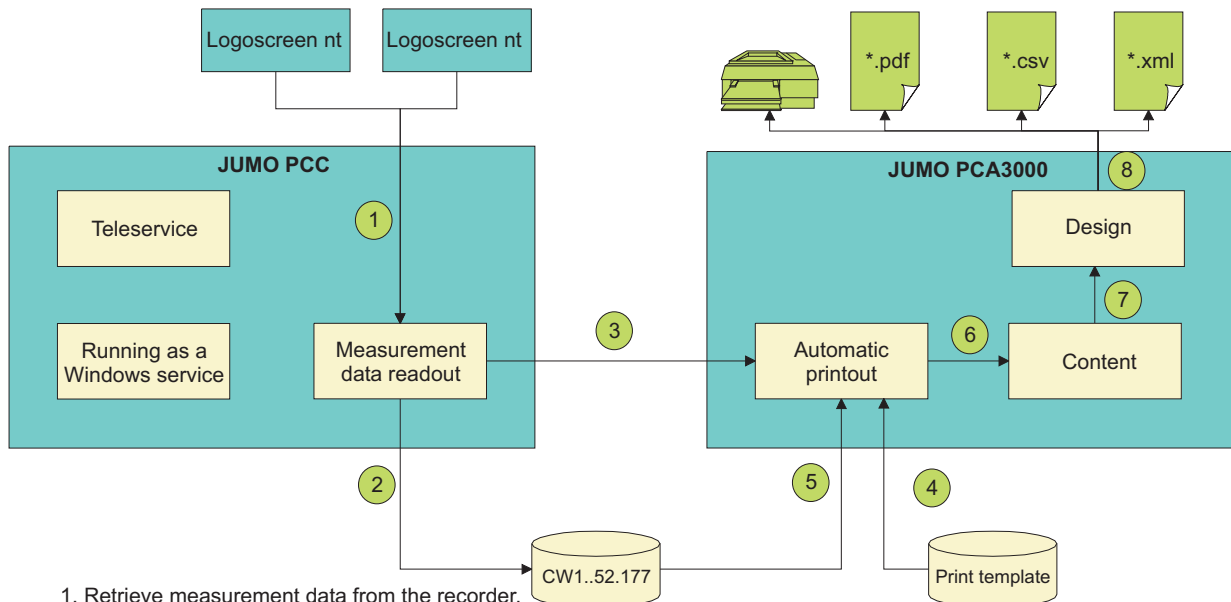

1. Retrieve measurement data from the recorder.
2. Store measurement data in archive files (*.177).
3. Activate "automatic printout" in PCA3000.
The print template is selected within PCC.
4. Read the print template. Print templates are created within PCA3000.
5. Data transfer from archive.
6. Determine the content defined in the print template.
7. Use the determined content in the defined design.
8. Output the completed design in the defined formats.

Interfaces

- USB interfaces (standard)
- RS232/RS485 interface (standard)
- RS232 interface for barcode reader (standard)
- Ethernet interface (standard)
- PROFIBUS-DP interface (extra code)

USB interfaces

With USB interfaces, a distinction is made between the host and the device interface. A USB memory stick can be attached to the host interface. The device interface, in conjunction with a standard commercial USB cable, is used to operate the setup program.

The paperless recorder without stainless steel front has host and device interfaces connected in parallel on both the front and back panels, of which only one of each type can ever be used. The paperless recorder with stainless steel front has only one host and one device interface at the rear panel.

RS232/RS485 interface

Current process data, as well as specific device data, can be read out via the RS232 or RS485 interface.

Data saved to the internal memory can also be read out in conjunction with the PC Evaluation Software PCA3000 and the PCA Communications Software (PCC).

The RS232 interface permits a maximum lead length of 15 m, the RS485 interface 1.2 km.

Connection is by a 9-pin SUB-D connector on the back of the instrument. Modbus (master and slave) protocols are available, and the transmission mode used is RTU (Remote Terminal Unit).

RS232 for barcode reader

A barcode reader can be attached to the interface. The barcode reader can be used to start or stop batch reporting, and to set batch texts (customer information, batch number...).

The barcode reader can also be operated via the RS232/RS485 interface, and the RS232 interface for the barcode reader can also be used as a Modbus master or slave.

	USB Host/Device	RS232 RS485	Ethernet	PROFIBUS-DP	External CF card
Read current measurement data	yes (device only)	yes	yes	yes	no
Write current measurement data	no	yes	yes	yes	no
Read out stored measurement data	yes	yes	yes	no	yes
Read /write configuration	yes	yes	yes	no	yes
Write user list	yes	yes	yes	no	yes

Ethernet interface

The Ethernet interface can be used in local networks for the communication between the recorder and the setup program and the PCA Communications Software. The IP address is set permanently through the configuration on the instrument or in the setup program, or can be automatically received from a DHCP server.

The integrated web server allows simultaneous access by several PCs to 3 HTML and 3 batch pages.

Transmission protocol: TCP/IP
Network type: 10BaseT, 100BaseT

PROFIBUS-DP interface

The recorder can be integrated into a fieldbus system according to the PROFIBUS-DP standard via the PROFIBUS-DP interface. This PROFIBUS version is especially designed for communication between automation systems and distributed peripheral devices at the field level.

Data are transmitted serially according to the RS485 standard, with a maximum 12 Mbits/sec.

Using the project design tool that is included in the delivery (GSD generator; GSD = device master file), an application-specific GSD file is created, which is used to integrate the recorder into the fieldbus system.

External CompactFlash memory card (CF)

For paperless recorders without stainless steel front, the external CompactFlash memory card (CF) is used to transfer the data from the internal memory to the PC. Configuration data can be created on the PC and then transferred to the recorder by means of the memory card.

On the PC side, data on the card is accessed using a read/write device (CompactFlash reader/writer).

External inputs via interface

The paperless recorder can acquire and store up to 54 external analog inputs and 54 binary inputs.

Furthermore, the interfaces can be used to enter comments in the event list of the recorder.

Stainless steel front (extra code 443 or 444)

The paperless recorder with extra code 443 or 444 (without extra code 350) may be installed in switch cabinets with at least a simplified pressurized enclosure. Under these conditions, use in a potentially explosive atmosphere (max. zones 1 and 21) is authorized from the front.

Notes on installation in Installation Instructions B 706581.4.1 must be complied with and followed.

Paperless recorders with authorization for explosion hazard areas, carry the following mark on the nameplate attached to the instrument.

 II 2G Ex px IIC

 II 2D Ex px IIIC

Caution: If extra code 443 or 444 is present, the CompactFlash memory card can no longer be used for external storage. Measurement data can be read out via one of the interfaces or via a USB memory stick (from the back).

Connection diagram

Rear view with pluggable screw terminals

Instrument variant 1

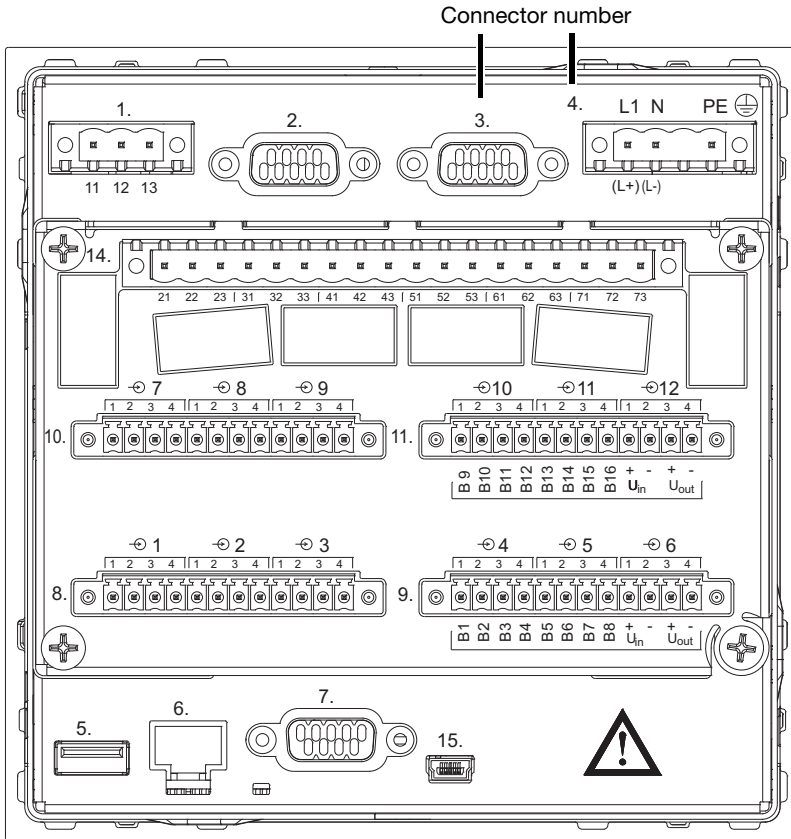

Module slot 3 (top)
fitted with one relay card.

Module slot 2 (middle)
fitted with 6 analog channels or
3 analog channels and
8 binary inputs/outputs.

Module slot 1 (bottom)
fitted with 6 analog channels or
3 analog channels and
8 binary inputs/outputs.

Instrument variant 2

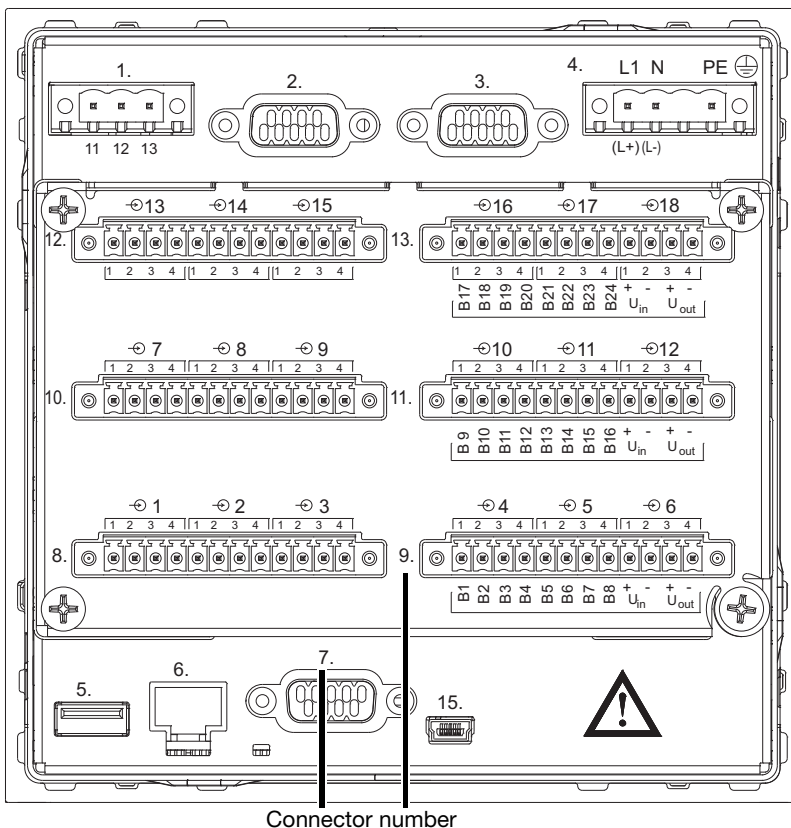

Module slot 3 (top)
fitted with 6 analog channels or
3 analog channels and
8 binary inputs/outputs.

Module slot 2 (middle)
fitted with 6 analog channels or
3 analog channels and
8 binary inputs/outputs.



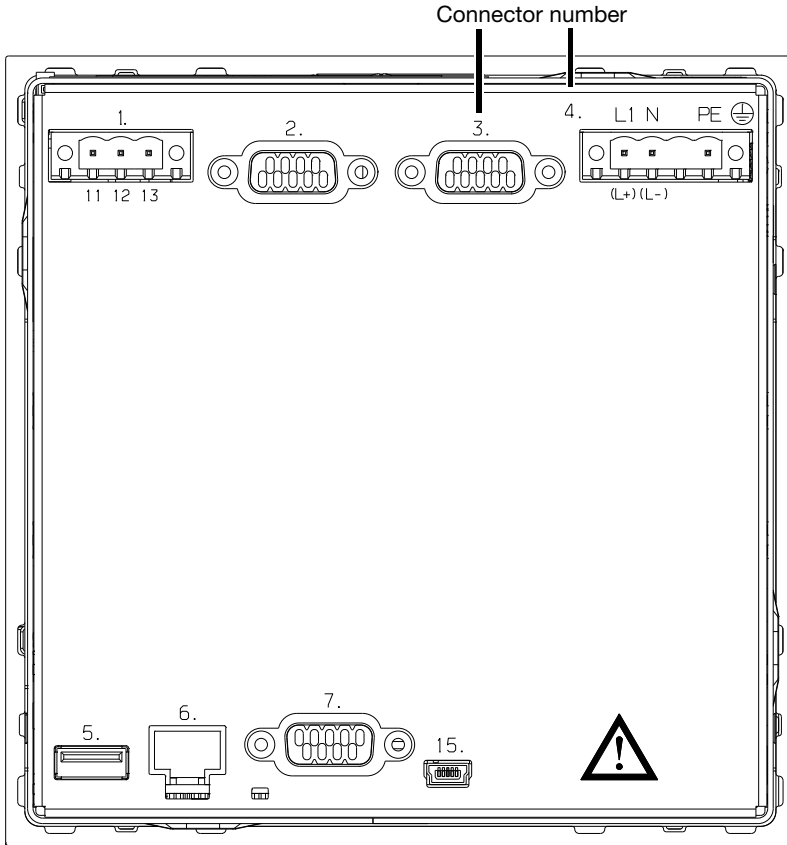

Module slot 1 (bottom)
fitted with 6 analog channels or
3 analog channels and
8 binary inputs/outputs.



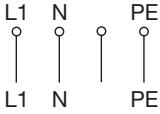
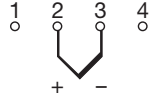
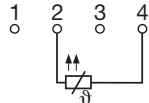
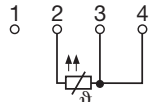
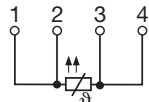
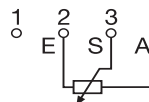
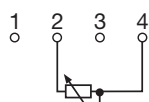
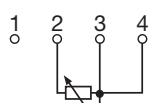
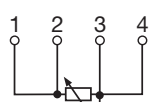
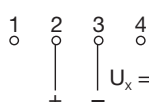
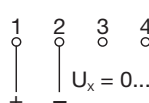
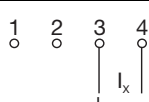

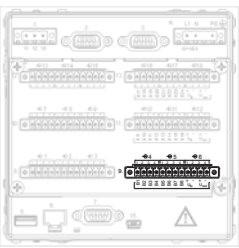
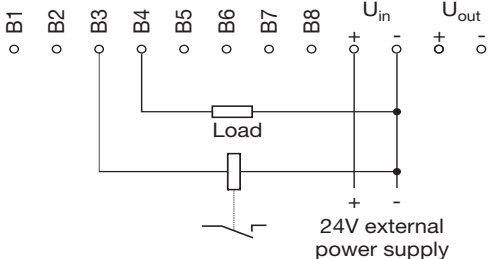
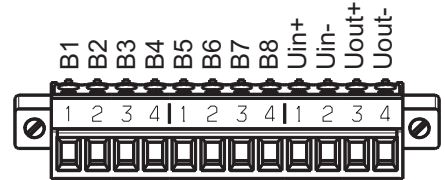

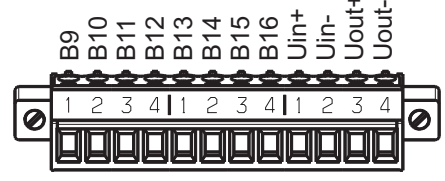
Instrument variant 3

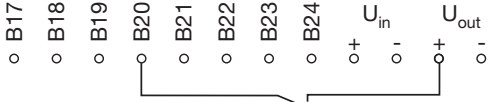
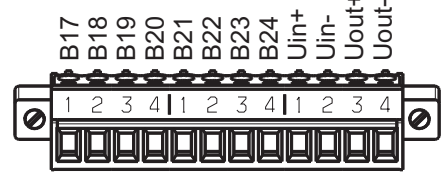

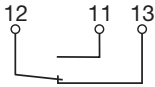
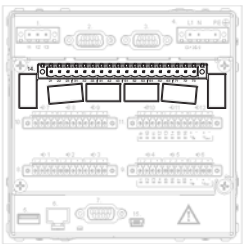
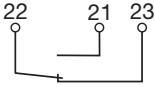
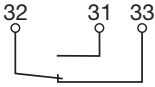
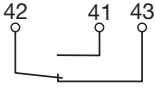
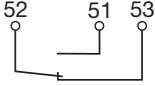
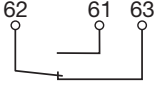
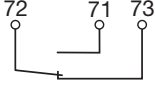
Module slot 1 to 3
without analog channels,
without binary inputs/outputs,
without relay card

Terminal assignment	Connector	Diagram	
Supply			
Supply as on nameplate	Connector 4 L1 (L+) N (L-) PE		
Analog inputs			
Thermocouple	Connectors 8 to 11 (input 1 to 12) for instrument variant 1		
RTD in 2-wire circuit			
RTD in 3-wire circuit			
RTD in 4-wire circuit			
Resistance transmitter		 <p>E = End S = Slider A = Start</p>	
Potentiometer in 2-wire circuit		or Connectors 8 to 13 (input 1 to 18) for instrument variant 2	
Potentiometer in 3-wire circuit			
Potentiometer in 4-wire circuit			
Voltage input 0 - 1V		 <p>$U_x = 0...1V$</p>	
Voltage input 0 - 10V		 <p>$U_x = 0...10V$</p>	
Current input	 <p>I_x</p>		

Terminal assignment	Connector	Diagram
<p>Binary inputs/outputs</p> <p> Configuration (through the setup program or on the instrument) defines which are binary inputs and which are outputs.</p>		
<p>B1 ... B8</p> <p>voltage-controlled LOW = -3 to +5V DC LOW = 12 to 30V DC</p> <p>internal power supply 24V/60mA (U_{out})</p> 	<p>Connector 9 only on modules with 3 analog inputs</p> <p>B1 binary input/output 1 ... B8 binary input/output 8</p> <p>U_{in+} external power supply U_{in-} ground U_{out+} +24V internal power supply U_{out-} ground</p>	 <p>Example: Connecting a load to binary output 4 (B4) and a solid-state relay to binary output 3 (B3) requires an external power supply.</p> <p>Diagram of the connector:</p> 
<p>B9 ... B16</p> <p>voltage-controlled LOW = -3 to +5V DC LOW = 12 to 30V DC</p> <p>internal power supply 24V/60mA (U_{out})</p> 	<p>Connector 11 only on modules with 3 analog inputs</p> <p>B9 binary input/output 9 ... B16 binary input/output 16</p> <p>U_{in+} external power supply U_{in-} ground U_{out+} +24V internal power supply U_{out-} ground</p>	 <p>Example: Binary input 12 (B12) is operated from the internal power supply.</p> <p>Diagram of the connector:</p> 
<p>B17 ... B24</p> <p>voltage-controlled LOW = -3 to +5V DC LOW = 12 to 30V DC</p> <p>internal power supply 24V/60mA (U_{out})</p> 	<p>Connector 13 only for instr. variant 2 and for modules with 3 analog inputs</p> <p>B17 binary input/output 17 ... B24 binary input/output 24</p> <p>U_{in+} external power supply U_{in-} ground U_{out+} +24V internal power supply U_{out-} ground</p>	 <p>Example: Binary input 20 (B20) is operated from the internal power supply.</p> <p>Diagram of the connector:</p> 

Terminal assignment	Connector	Diagram
Relay outputs		
Relay 1 changeover (SPDT)	Connector 1 	
Relay 2 changeover (SPDT)	Connector 14 only for instrument variant 1 	
Relay 3 changeover (SPDT)		
Relay 4 changeover (SPDT)		
Relay 5 changeover (SPDT)		
Relay 6 changeover (SPDT)		
Relay 7 changeover (SPDT)		
Interfaces		
RS232 for barcode reader 9-pin SUB-D socket connector	Connector 2 	2 RxD Receive Data 3 TxD Transmit Data 5 GND Ground
PROFIBUS-DP 9-pin SUB-D socket connector (extra code)	Connector 3 	3 RxD/TxD-P Receive/Transmit Data-Pos. B conductor 5 DGND Ground for data transmission 6 VP Voltage supply-Pos. 8 RxD/TxD-P Receive/Transmit Data-Neg. A conductor
USB host interface for connecting memory sticks	Connector 5 	The recorder without stainless steel front also has a USB host interface on the front panel, connected in parallel. The two interfaces cannot both be operated at the same time.
Ethernet RJ45 socket connector	Connector 6 	1 TX+ Transmit Data + 2 TX- Transmit Data - 3 RX+ Receive Data + 6 RX- Receive Data -
RS232 9-pin SUB-D socket connector (switchable to RS485)	Connector 7 	2 RxD Receive Data 3 TxD Transmit Data 5 GND Ground
RS485 9-pin SUB-D socket connector (switchable to RS232)	Connector 7 	3 TxD+/RxD+ Transmit/Receive Data + 5 GND Ground 8 TxD-/RxD- Transmit/Receive Data -

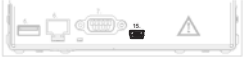
Terminal assignment	Connector	Diagram
USB host interface for connecting a PC	Connector 15 	The recorder without stainless steel front also has a USB device interface on the front panel, connected in parallel. The two interfaces cannot both be operated at the same time.

Overview of the electrical isolation

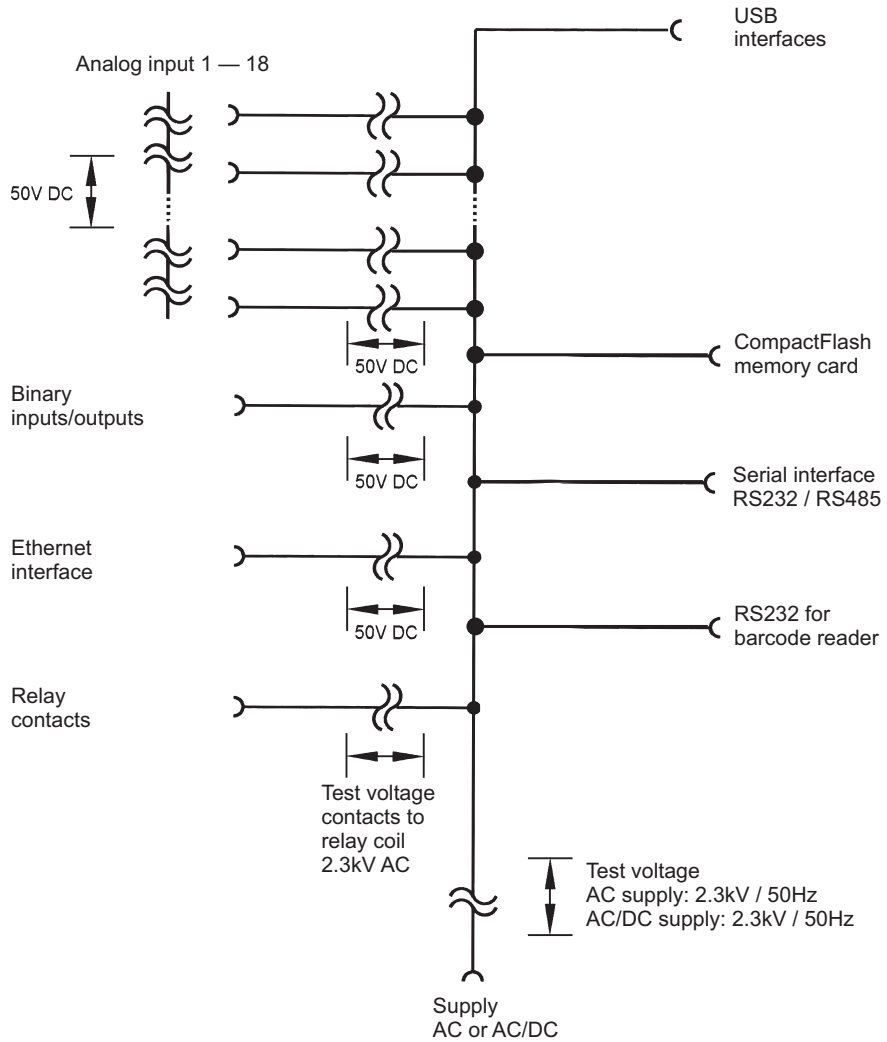

Dimensions

Recorder with die-cast zinc front

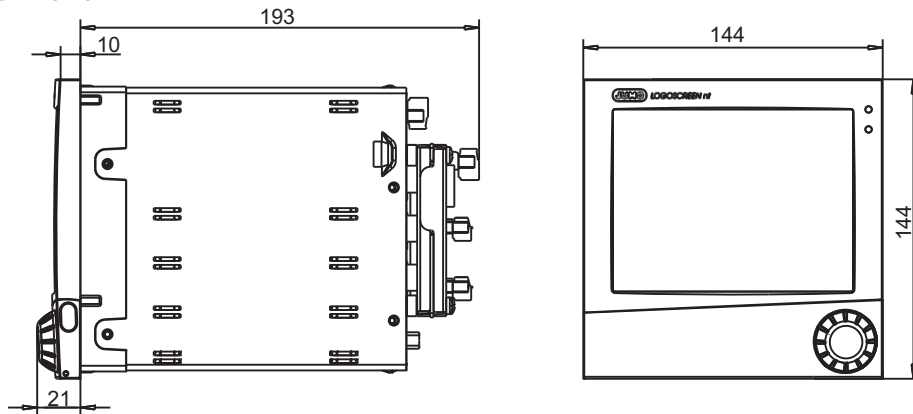

Recorder with stainless steel front (extra code 443 or 444)

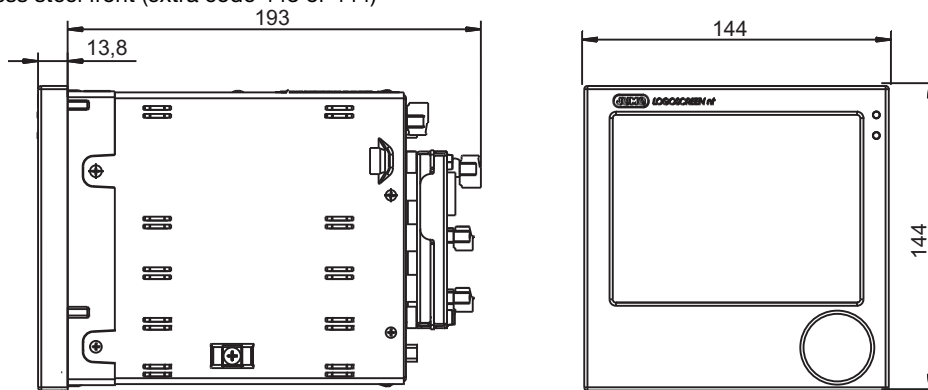

Panel cut-out

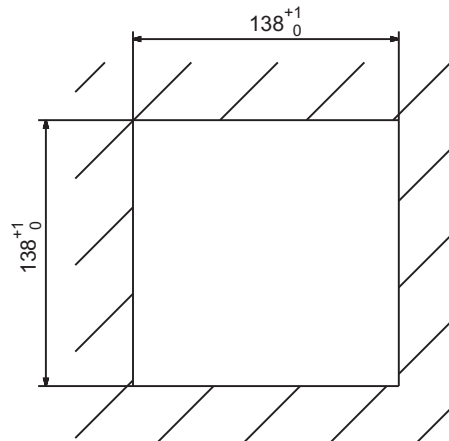

Universal carrying case option - TG-35

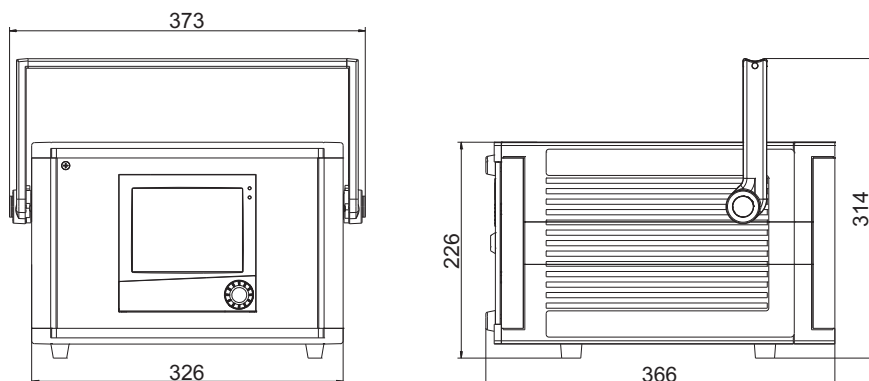

Standard accessories

- 1 Installation instructions B 706581.4.1
- 1 Operating instructions B 706581.1
- 4 mounting brackets
- 1 panel seal
- 1 CD with detailed operating instructions and additional documentation

Accessories

- Setup program (incl. USB cable)
- PC Evaluation software PCA3000
- PCA Communications software PCC
- CompactFlash memory cards and USB memory sticks
The CF cards and memory sticks specified by JUMO are tested and designed for industrial applications. Other makes cannot be guaranteed.