





3.0 W Surface Mount Glass Passivated Zener

<p>DO-214AA (SMB)</p> 	<p>Voltage 6.2 to 200 V</p>	<p>Power Dissipation 3.0 W</p>	
			
	<p>FEATURES</p> <ul style="list-style-type: none"> • Low profile package • Ideal for automated placement • Low leakage current • High surge current and zener capability • Low differential resistance • Tolerance series $\pm 5\%$ • Low forward voltage drop • Solder dip 260°C, 10s • AEC-Q101 qualified • Component in accordance to RoHS 2011/65/EU and WEEE 2002/96/EC • Meets MSL level 1, per J-STD-020, LF maximum peak of 260° C 		   RoHS COMPLIANT
	<p>MECHANICAL DATA</p> <ul style="list-style-type: none"> • Case: DO-214AA (SMB). Epoxy meets UL 94V-0 flammability rating. • Polarity: Color band denotes cathode end. • Terminals: Matte tin plated leads, solderable per MIL-STD-750 Method 2026, J-STD-002 and JESD22-B102. Consumer grade, meets JESD 201 class 1A whisker test. • HE3 suffix for high reliability grade, meets JESD 201 class 2 whisker test. 		
<p>TYPICAL APPLICATIONS</p> <p>Used for basic regulation functions in most electronic applications, Zener diodes offer a cheaper alternative to IC solutions.</p>			

Maximum Ratings and Electrical Characteristics at 25 °C

P_{tot}	Power dissipation at $T_L = 75\text{ °C}$	3.0 W
T_j	Operating temperature range	- 65 to + 150 °C
T_{stg}	Storage temperature range	- 65 to + 150 °C
V_F	Max. forward voltage drop at $I_F = 1.0\text{ A}$	1.1 V
$R_{th(j-l)}$	Typical Thermal Resistance	20 °C/W
$R_{th(j-a)}$	(5x5 mm ² x 130 μ Copper Area)	60 °C/W

3.0 W Surface Mount Glass Passivated Zener

Ordering information

PREFERRED P/N	PACKAGE CODE	DELIVERY MODE	BASE QUANTITY	UNIT WEIGHT (g)
Z2SMB51 TRTB	TRTB	13" diameter tape and reel	3,200	0.082
Z2SMB51 TRTS	TRTS	7" diameter tape and reel	750	0.082
Z2SMB51 HE3 TRTB	TRTB	13" diameter tape and reel	3,200	0.082

Package Outline Dimensions: (mm) DO-214AA (SMB)

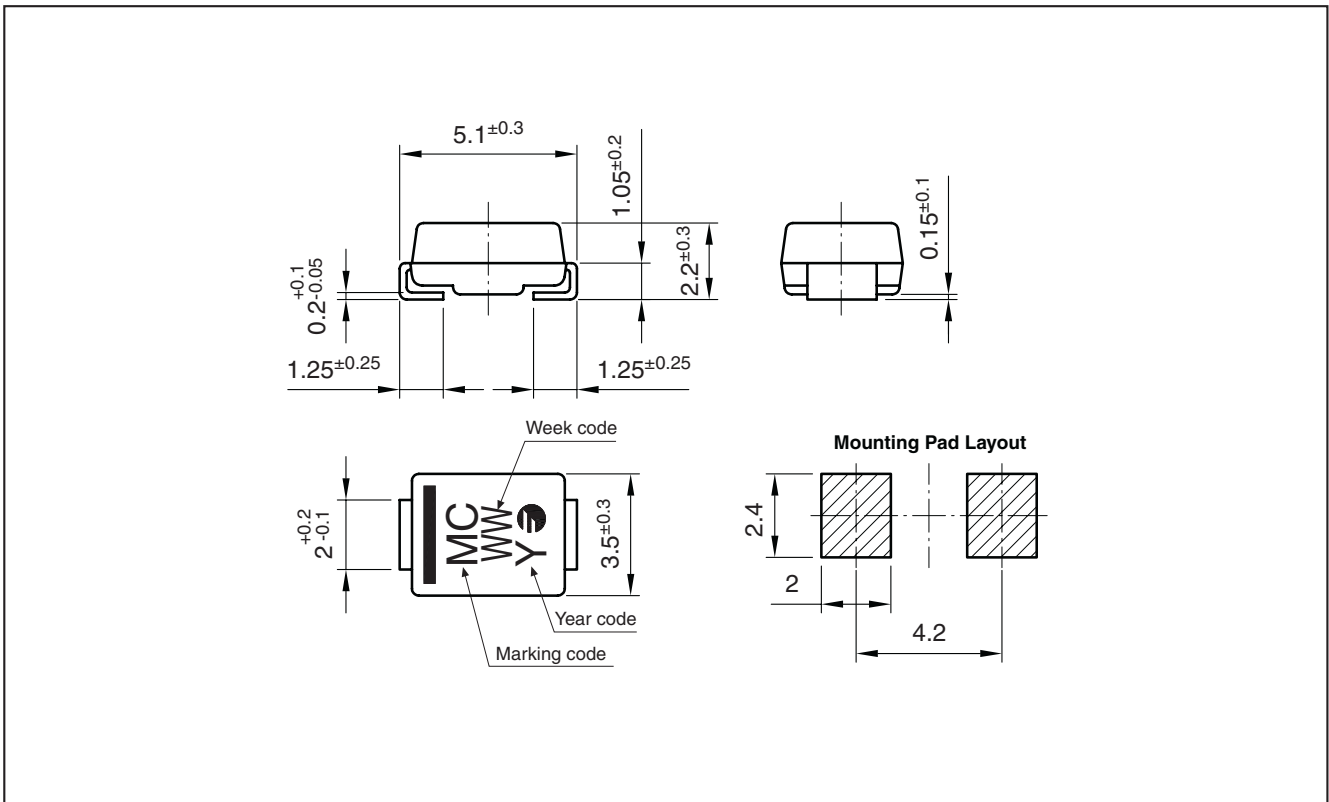

3.0 W Surface Mount Glass Passivated Zener
Ratings and Characteristics (Ta 25 °C unless otherwise noted)

Type	Marking Code	Zener (1) Voltage Range V _Z at I _{ZT}	Maximum Zener Impedance Z _{ZT} at I _{ZT}	Typical Temperature Coefficient at I _{ZT}	Test Current I _{ZT}	Max Reverse Leakage Current		Max Regulator Current at 45 °C I _{ZM}	Surge Current (10ms) I _{ZS}
		(V)	(Ω)	(% / °C)	(mA)	I _R (μA)	@ V _R (V)	(mA)	(mA)
Z2SMB6V2	JE	5.8-6.6	2	+0.025	100	10	3	245	9600
Z2SMB6V8	GE	6.4-7.2	2	+0.035	100	10	4	220	8820
Z2SMB7V5	GD	7.0-7.9	2	+0.035	100	5	6	200	8000
Z2SMB8V2	GF	7.7-8.7	2	+0.055	100	5	6.5	180	7300
Z2SMB9V1	GG	8.5-9.6	4	+0.055	50	5	7	165	6590
Z2SMB10	GH	9.4-10.6	4	+0.070	50	1	7.5	145	6000
Z2SMB11	GK	10.4-11.6	7	+0.075	50	1	8.3	135	5450
Z2SMB12	GL	11.4-12.7	7	+0.075	50	1	9.1	120	5000
Z2SMB13	GM	12.4-14.1	10	+0.075	50	1	9.9	110	4600
Z2SMB15	GN	13.8-15.6	10	+0.075	50	1	11.4	98	4000
Z2SMB16	GP	15.3-17.1	15	+0.085	25	1	12.2	90	3750
Z2SMB18	GQ	16.8-19.1	15	+0.085	25	1	13.7	80	3330
Z2SMB20	GR	18.8-21.2	15	+0.085	25	1	15.2	72	3000
Z2SMB22	GS	20.8-23.3	15	+0.085	25	1	16.7	66	2700
Z2SMB24	GT	22.8-25.6	15	+0.085	25	1	18.2	60	2500
Z2SMB27	GU	25.1-28.9	15	+0.085	25	1	20.5	53	2200
Z2SMB30	GV	28-32	15	+0.085	25	1	22.8	48	2000
Z2SMB33	GW	31-35	15	+0.085	25	1	25	44	1800
Z2SMB36	GX	34-38	40	+0.085	10	1	27.4	40	1600
Z2SMB39	GY	37-41	40	+0.085	10	1	29.6	37	1500
Z2SMB43	GZ	40-46	45	+0.095	10	1	32.7	33	1300
Z2SMB47	HD	44-50	45	+0.095	10	1	35.7	30	1200
Z2SMB51	HF	48-54	60	+0.095	10	1	38.8	27	1100
Z2SMB56	HG	52-60	60	+0.095	10	1	42.5	25	1000
Z2SMB62	HH	58-66	80	+0.105	10	1	47.1	21	960
Z2SMB68	HK	64-72	80	+0.105	10	1	51.7	20	880
Z2SMB75	HL	70-80	100	+0.105	10	1	57	18	800
Z2SMB82	HM	77-87	100	+0.105	10	1	62.4	16	730
Z2SMB91	HN	85-96	200	+0.110	5	1	69.2	15	650
Z2SMB100	HP	94-106	200	+0.110	5	1	76	13	600
Z2SMB110	HQ	104-116	250	+0.110	5	1	83.5	12	550
Z2SMB120	HR	114-127	250	+0.110	5	1	91.2	11	500
Z2SMB130	HS	124-141	300	+0.110	5	1	98.2	10	460
Z2SMB150	HT	138-156	300	+0.110	5	1	114	9	400
Z2SMB160	HU	153-171	350	+0.110	5	1	122	8.5	375
Z2SMB180	HV	168-191	400	+0.110	5	1	137	8.0	330
Z2SMB200	HW	188-212	450	+0.110	5	1	152	7.5	300

(1) Tested with pulses.
Pulse test: t_p ≤ 50 ms; δ < 2%

3.0 W Surface Mount Glass Passivated Zener

Ratings and Characteristics (Ta 25 °C unless otherwise noted)

MAXIMUM CONTINUOUS POWER DISSIPATION

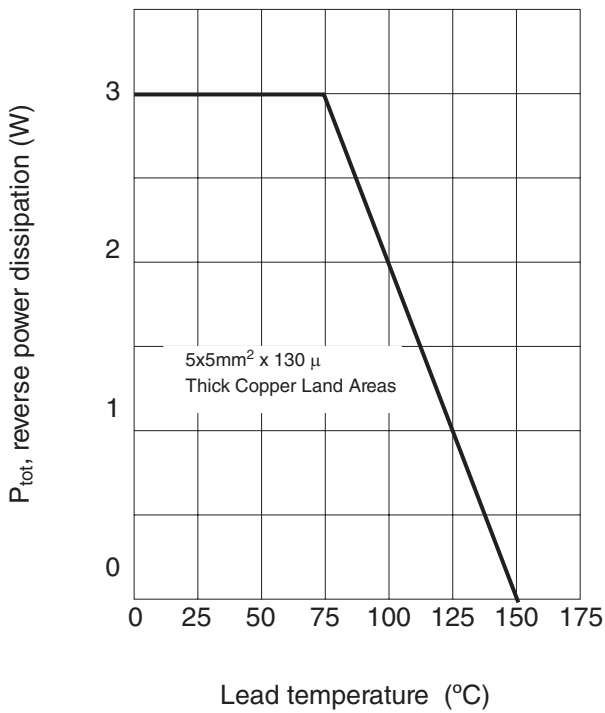

TYPICAL FORWARD CHARACTERISTIC

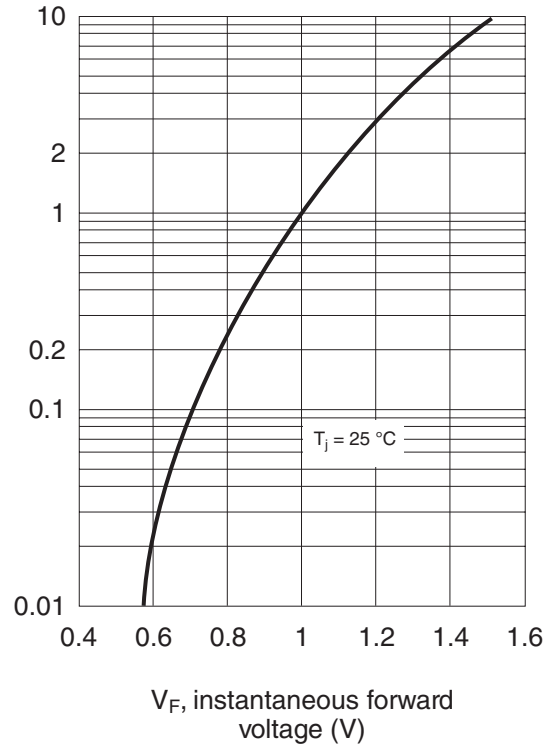

TYPICAL ZENER IMPEDANCE

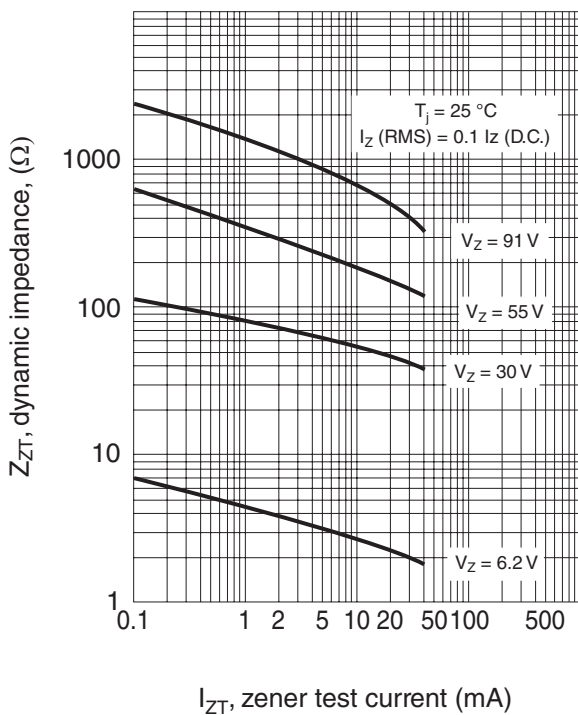

TYPICAL REVERSE CHARACTERISTIC

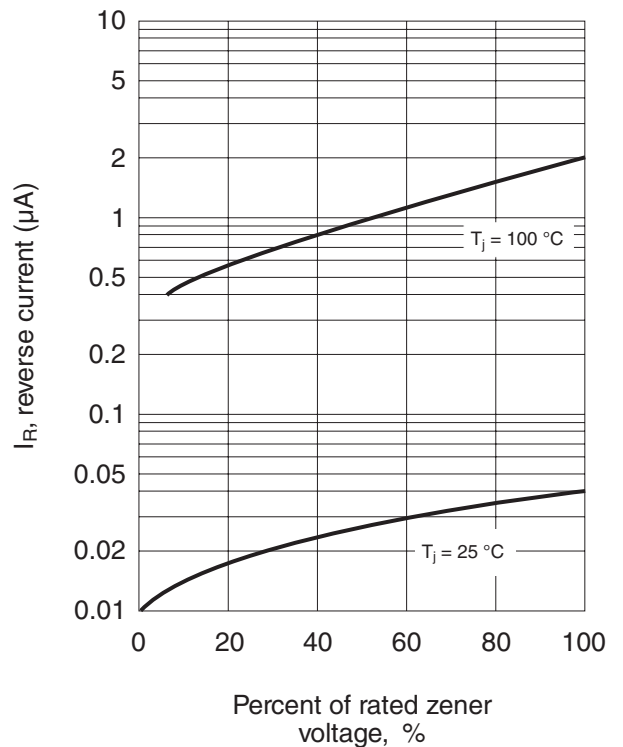

3.0 W Surface Mount Glass Passivated Zener

Ratings and Characteristics (Ta 25 °C unless otherwise noted)

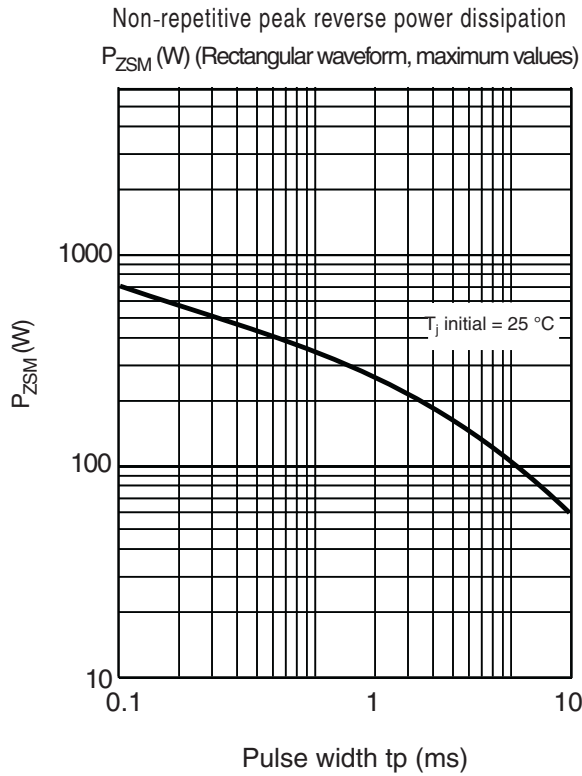

3.0 W Surface Mount Glass Passivated Zener**Revision History**

Date	Revision	Description of Changes
12-Apr-2012	0	Original Data Sheet
8-May-2014	1	Updated maximum continuous power dissipation.

Disclaimer

All product, product specifications and data are subject to change without notice to improve reliability, function or design or otherwise.

Fagor Electrónica, S.Coop., its affiliates, agents, and employees, and all persons acting on its or their behalf (collectively, "Fagor"), disclaim any and all liability for any errors, inaccuracies or incompleteness contained in any datasheet or in any other disclosure relating to any product.

Fagor makes no warranty, representation or guarantee regarding the suitability of the products for any particular purpose or the continuing production of any product. To the maximum extent permitted by applicable law, Fagor disclaims (i) any and all liability arising out of the application or use of any product, (ii) any and all liability, including without limitation special, consequential or incidental damages, and (iii) any and all implied warranties, including warranties of fitness for particular purpose, non-infringement and merchantability.

Statements regarding the suitability of products for certain types of applications are based on Fagor's knowledge of typical requirements that are often placed on Fagor products in generic applications. Such statements are not binding statements about the suitability of products for a particular application. It is the customer's responsibility to validate that a particular product with the properties described in the product specification is suitable for use in a particular application. Parameters provided in datasheets and/or specifications may vary in different applications and performance may vary over time. All operating parameters, including typical parameters, must be validated for each customer application by the customer's technical experts. Product specifications do not expand or otherwise modify Fagor's terms and conditions of purchase, including but not limited to the warranty expressed therein.

Except as expressly indicated in writing, Fagor products are not designed for use in medical, life-saving, or life-sustaining applications or for any other application in which the failure of the Fagor product could result in personal injury or death. Customers using or selling Fagor products not expressly indicated for use in such applications do so at their own risk and agree to fully indemnify and hold Fagor and its distributors harmless from and against any and all claims, liabilities, expenses and damages arising or resulting in connection with such use or sale, including attorneys fees, even if such claim alleges that Fagor or its distributor was negligent regarding the design or manufacture of the part. Please contact authorized Fagor personnel to obtain written terms and conditions regarding products designed for such applications.

No license, express or implied, by estoppel or otherwise, to any intellectual property rights is granted by this document or by any conduct of Fagor, Product names and markings noted herein may be trademarks of their respective owners.