

ZB5AJ3

Frontelement Wahlschalter - 3 Stellungen - Ø 22 -
schwarz



Hauptkenndaten

Produktserie	Harmony XB5
Produkt oder Komponententyp	Kopf für Wahlschalter
Kurzbezeichnung des Geräts	ZB5
Blendenmaterial	Kunststoff
Montagedurchmesser	22 mm
Verkauf je unteilbare Menge	1
Form des Signaleinheitkopfes	Rund
Operatortyp	Rastend
Profil Betätigungselement	Schwarz langer Griff
Zusätzliche Betriebsinformationen	Nicht abschließbar
Betriebs-Positionsinformation	3 Positionen +/- 45°

Zusatzdaten

CAD-Gesamtbreite	29 mm
CAD-Gesamthöhe	38 mm
CAD-Gesamttiefe	46 mm
Produktgewicht	0,017 kg
Mechanische Lebensdauer	1000000 Zyklen
Stationsname	XALD 1-5 Ausschnitte XALK 2-5 Ausschnitte
Code für den elektrischen Aufbau	C11 für <= 3 Kontakte in einfach Blöcke in Frontmontage SF1 für <= 3 Kontakte in einfach Blöcke in Frontmontage SR1 für <= 3 Kontakte in einfach Blöcke in rückseitige Montage C3 für <= 6 Kontakte in einfach Blöcke in Frontmontage C4 für <= 6 Kontakte in einfach und doppelt Blöcke in Frontmontage C7 für <= 4 Kontakte in einfach Blöcke in Frontmontage C8 für <= 4 Kontakte in einfach und doppelt Blöcke in Frontmontage C5 für <= 5 Kontakte in einfach Blöcke in Frontmontage C6 für <= 5 Kontakte in einfach und doppelt Blöcke in Frontmontage

Umgebung

Schutzbehandlung	TH
Umgebungstemperatur bei Lagerung	-40-70 °C
Umgebungstemperatur bei Betrieb	-40-70 °C
Überspannungskategorie	Klasse II entspricht IEC 60536
Schutzart (IP)	IP67 entspricht IEC 60529 IP69K IP69 entspricht IEC 60529
Schutzart (NEMA)	NEMA 13 NEMA 4X
Widerstandsfähigkeit gegen Hochdruckreiniger	7000000 Pa bei 55 °C, Entfernung: 0,1 m
IK-Schutzart	IK06 entspricht IEC 50102
Normen	EN/IEC 60947-1 EN/IEC 60947-5-1 EN/IEC 60947-5-4 JIS C 4520 UL 508 CSA C22.2 No 14
Produktzertifizierungen	BV CSA DNV GL

Die in dieser Dokumentation bereitgestellten Informationen beinhalten allgemeine Beschreibungen und/oder technische Daten und Leistungsmerkmale der entsprechenden Produkte. Diese Dokumentation ist nicht als Ersatz für eine Eignungsbestimmung gedacht und darf nicht dazu verwendet werden, die Eignung oder Zuverlässigkeit dieser Produkte für spezifische Benutzeranwendungen zu bestimmen. Jeder Benutzer oder Integrator ist verpflichtet, geeignete und vollständige Risikoanalysen, Evaluierungen und Tests der Produkte im Hinblick auf die jeweilige spezifische Anwendung oder Verwendung durchzuführen. Weder Schneider Electric Industries SAS noch seine angegliederten Unternehmen sind für den fehlerhaften Gebrauch oder Missbrauch der gelieferten Informationen verantwortlich oder haftbar zu machen.

Vibrationsfestigkeit	5 gn (f = 2...500 Hz) entspricht IEC 60068-2-6
Stoßfestigkeit	30 gn (Dauer = 18 ms) für Sinushalbwellenbeschleunigung entspricht IEC 60068-2-27 50 gn (Dauer = 11 ms) für Sinushalbwellenbeschleunigung entspricht IEC 60068-2-27

Contractual warranty

Periode	18 Monate
---------	-----------

Dimensions

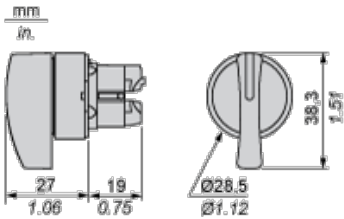

Panel Cut-out for Pushbuttons, Switches and Pilot Lights (Finished Holes, Ready for Installation)

Connection by Screw Clamp Terminals or Plug-in Connectors or on Printed Circuit Board

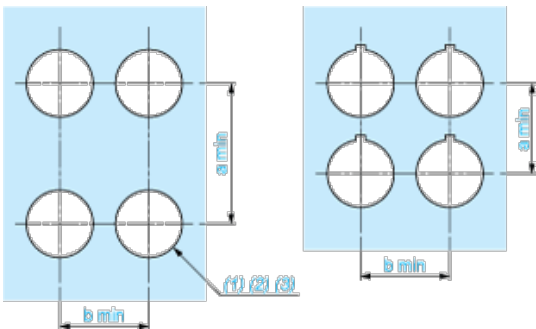

- (1) Diameter on finished panel or support
- (2) For selector switches and Emergency stop buttons, use of an anti-rotation plate type ZB5AZ902 is recommended.
- (3) Ø22.5 mm recommended (Ø22.3^{+0.4}) / Ø0.89 in. recommended (Ø0.88 in.^{+0.016})

Connections	a in mm	a in in.	b in mm	b in in.
By screw clamp terminals or plug-in connector	40	1.57	30	1.18
By Faston connectors	45	1.77	32	1.26
On printed circuit board	30	1.18	30	1.18

Detail of Lug Recess

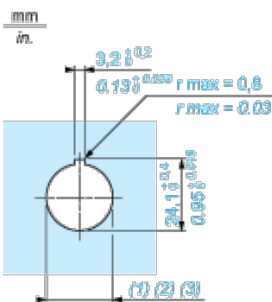

- (1) Diameter on finished panel or support
- (2) For selector switches and Emergency stop buttons, use of an anti-rotation plate type ZB5AZ902 is recommended.
- (3) Ø22.5 mm recommended (Ø22.3^{+0.4}) / Ø0.89 in. recommended (Ø0.88 in.^{+0.016})

Pushbuttons, Switches and Pilot Lights for Printed Circuit Board Connection

Panel Cut-outs (Viewed from Installer's Side)

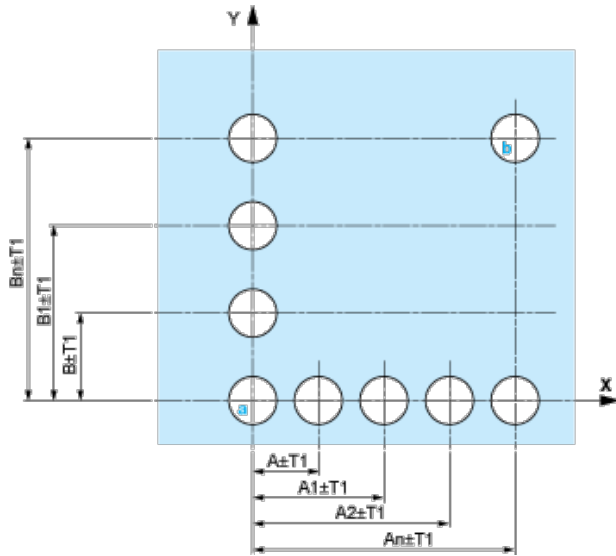

A: 30 mm min. / 1.18 in. min.

B: 40 mm min. / 1.57 in. min.

Printed Circuit Board Cut-outs (Viewed from Electrical Block Side)

Dimensions in mm

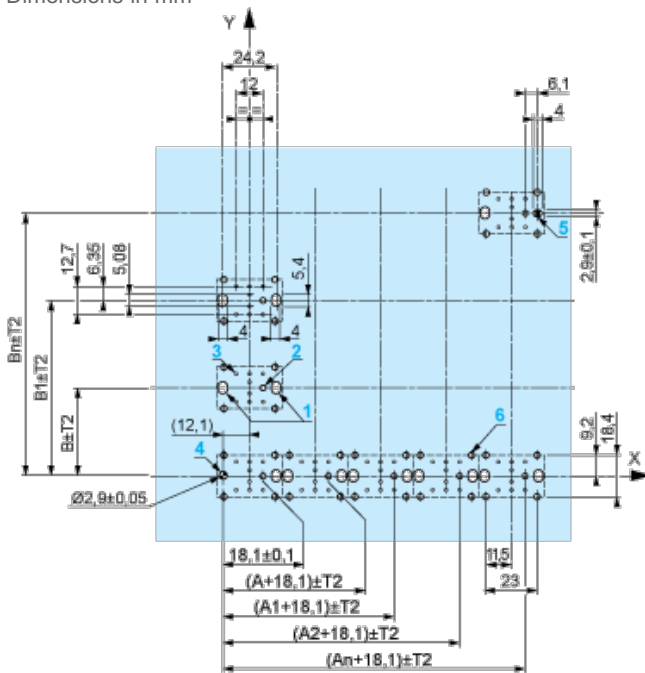

A: 30 mm min.

B: 40 mm min.

Dimensions in in.



A: 1.18 in. min.

B: 1.57 in. min.

General Tolerances of the Panel and Printed Circuit Board

The cumulative tolerance must not exceed 0.3 mm / 0.012 in.: $T1 + T2 = 0.3 \text{ mm max.}$

Installation Precautions

- | Minimum thickness of circuit board: 1.6 mm / 0.06 in.
- | Cut-out diameter: 22.4 mm \pm 0.1 / 0.88 in. \pm 0.004
- | Orientation of body/fixing collar ZB5AZ009: \pm 2°30' (excluding cut-outs marked **a** and **b**).
- | Tightening torque of screws ZBZ006: 0.6 N.m (5.3 lbf.in) max.
- | Allow for one ZB5AZ079 fixing collar/pillar and its fixing screws:
 - | every 90 mm / 3.54 in. horizontally (X), and 120 mm / 4.72 in. vertically (Y).
 - | with each selector switch head (ZB5AD•, ZB5AJ•, ZB5AG•).

The fixing centers marked **a** and **b** are diagonally opposed and must align with those marked **4** and **5**.



- (1) Head ZB5AD•
- (2) Panel
- (3) Nut
- (4) Printed circuit board

Mounting of Adapter (Socket) ZBZ01•

- | 1 2 elongated holes for ZBZ006 screw access
- | 2 1 hole \varnothing 2.4 mm \pm 0.05 / 0.09 in. \pm 0.002 for centring adapter ZBZ01•
- | 3 8 \times \varnothing 1.2 mm / 0.05 in. holes
- | 4 1 hole \varnothing 2.9 mm \pm 0.05 / 0.11 in. \pm 0.002, for aligning the printed circuit board (with cut-out marked **a**)

- | 5 1 elongated hole for aligning the printed circuit board (with cut-out marked **b**)
- | 6 4 holes \varnothing 2.4 mm / 0.09 in. for clipping in adapter ZBZ01•

Dimensions An + 18.1 relate to the \varnothing 2.4 mm \pm 0.05 / 0.09 in. \pm 0.002 holes for centring adapter ZBZ01•.

Electrical Composition Corresponding to Code C3



Electrical Composition Corresponding to Code C4

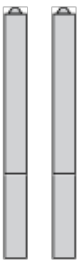

Electrical Composition Corresponding to Code C5

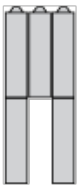

Electrical Composition Corresponding to Code C6

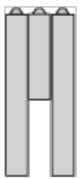

Electrical Composition Corresponding to Code C7

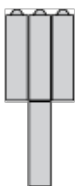

Electrical Composition Corresponding to Code C8



Electrical Composition Corresponding to Codes C9, C11, SF1 and SR1



Electrical Composition Corresponding to Code C15

1 N/O



1 N/C



1 N/O + N/C or 1 N/O + N/O or 1 N/C + N/C



Legend

Single contact



Double contact



Light block





Possible location



Sequence of Contacts Fitted to 3-position Selector Switch Body

Position 315°



Push	Position	Top			
		Bottom			
	Location		Left	Centre	Right
	State		1	1	0
Contacts	N/O		closed	closed	open
	N/C		open	open	closed



Position 0°



Push	Position	Top			
		Bottom			
	Location		Left	Centre	Right
	State		0	0	0
Contacts	N/O		open	open	open
	N/C		closed	closed	closed

Position 45°



Push	Position	Top			
		Bottom			
	Location		Left	Centre	Right
	State		0	1	1
Contacts	N/O		open	closed	closed
	N/C		closed	open	open