

86 mm sq.

1.8°/step RoHS

Bipolar winding, Lead wire type
 Bipolar winding, Lead wire type CE/UL model
 Bipolar winding, Terminal block type CE/UL model
 Unipolar winding, Lead wire type ▶ p. 62
 Unipolar winding, Lead wire type CE/UL model ▶ p. 62

Customizing

Hollow Shaft modification
Encoder

Varies depending on the model number and quantity. Contact us for details.

Bipolar winding, Lead wire type

Model no.		Holding torque at 2-phase energization N·m min.	Rated current A/phase	Wiring resistance Ω/phase	Winding inductance mH/phase	Rotor inertia ×10 ⁻⁴ kg·m ²	Mass kg	Motor length (L) mm
Single shaft	Dual shaft							
SH2861-5041	SH2861-5011	3.3	2	2.2	15	1.48	1.75	66
SH2861-5141	SH2861-5111	3.3	4	0.56	3.7	1.48	1.75	66
SH2861-5241	SH2861-5211	3.3	6	0.29	1.7	1.48	1.75	66
SH2862-5041	SH2862-5011	6.4	2	3.2	25	3.0	2.9	96.5
SH2862-5141	SH2862-5111	6.4	4	0.83	6.4	3.0	2.9	96.5
SH2862-5241	SH2862-5211	6.4	6	0.36	2.8	3.0	2.9	96.5
SH2863-5041	SH2863-5011	9	2	4.0	32	4.5	4.0	127
SH2863-5141	SH2863-5111	9	4	1.0	7.9	4.5	4.0	127
SH2863-5241	SH2863-5211	9	6	0.46	3.8	4.5	4.0	127

Bipolar winding, Lead wire type CE/UL model

Model no.		Holding torque at 2-phase energization N·m min.	Rated current A/phase	Wiring resistance Ω/phase	Winding inductance mH/phase	Rotor inertia ×10 ⁻⁴ kg·m ²	Mass kg	Motor length (L) mm
Single shaft	Dual shaft							
SM2861-5051	SM2861-5021	3.3	2	2.2	15	1.48	1.75	66
SM2861-5151	SM2861-5121	3.3	4	0.56	3.7	1.48	1.75	66
SM2861-5251	SM2861-5221	3.3	6	0.29	1.7	1.48	1.75	66
SM2862-5051	SM2862-5021	6.4	2	3.2	25	3.0	2.9	96.5
SM2862-5155	SM2862-5121	6.4	4	0.83	6.4	3.0	2.9	96.5
SM2862-5255	SM2862-5225	6.4	6	0.36	2.8	3.0	2.9	96.5
SM2863-5051	SM2863-5021	9	2	4.0	32	4.5	4.0	127
SM2863-5151	SM2863-5121	9	4	1.0	7.9	4.5	4.0	127
SM2863-5251	SM2863-5221	9	6	0.46	3.8	4.5	4.0	127

Bipolar winding, Terminal block type CE/UL model

Model no.		Holding torque at 2-phase energization N·m min.	Rated current A/phase	Wiring resistance Ω/phase	Winding inductance mH/phase	Rotor inertia ×10 ⁻⁴ kg·m ²	Mass kg	Motor length (L) mm
Single shaft								
SM2861-5066		3.3	2	2.03	15	1.48	1.9	97.9
SM2861-5166		3.3	4	0.52	3.7	1.48	1.9	97.9
SM2861-5266		3.3	6	0.27	1.7	1.48	1.9	97.9
SM2862-5066		6.4	2	3.08	25	3.0	3.05	128.4
SM2862-5166		6.4	4	0.79	6.4	3.0	3.05	128.4
SM2862-5266		6.4	6	0.33	2.8	3.0	3.05	128.4
SM2863-5066		9	2	3.83	32	4.5	4.15	158.8
SM2863-5166		9	4	0.96	7.9	4.5	4.15	158.8
SM2863-5266		9	6	0.48	3.8	4.5	4.15	158.8

Characteristics diagram

SH2861-5041
SH2861-5011

SM2861-5051
SM2861-5021

SM2861-5066

Constant current circuit
 Source voltage: 100 VAC
 Operating current:
 2 A/phase, 2-phase
 energization (full-step)
 Pull-out torque:
 $J_L=15.3 \times 10^{-4} \text{kg} \cdot \text{m}^2$ (use the
 rubber coupling)
 fs: Maximum self-start
 frequency when not
 loaded

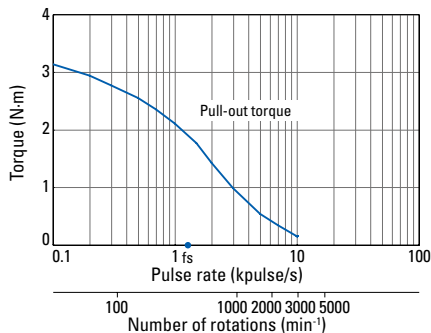

SH2861-5141
SH2861-5111

SM2861-5151
SM2861-5121

SM2861-5166

Constant current circuit
 Source voltage: 100 VAC
 Operating current:
 4 A/phase, 2-phase
 energization (full-step)
 Pull-out torque:
 $J_L=15.3 \times 10^{-4} \text{kg} \cdot \text{m}^2$ (use the
 rubber coupling)
 fs: Maximum self-start
 frequency when not
 loaded

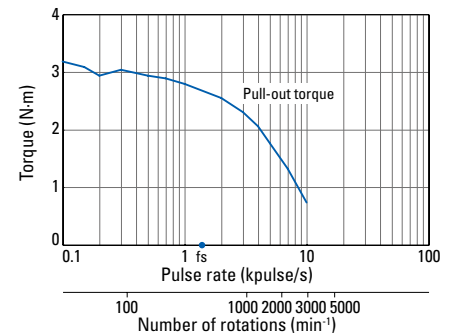

Characteristics diagram

SH2861-5241
SH2861-5211

SM2861-5251
SM2861-5221

SM2861-5266

Constant current circuit
Source voltage: 100 VAC
Operating current:
6 A/phase, 2-phase
energization (full-step)
Pull-out torque:
 $J_L=15.3 \times 10^{-4} \text{kg}\cdot\text{m}^2$ (use the
rubber coupling)
fs: Maximum self-start
frequency when not
loaded

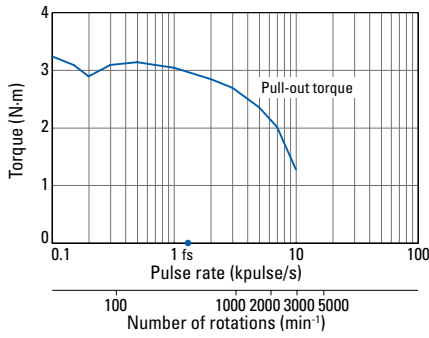

SH2862-5041
SH2862-5011

SM2862-5051
SM2862-5021

SM2862-5066

Constant current circuit
Source voltage: 100 VAC
Operating current:
2 A/phase, 2-phase
energization (full-step)
Pull-out torque:
 $J_L=15.3 \times 10^{-4} \text{kg}\cdot\text{m}^2$ (use the
rubber coupling)
fs: Maximum self-start
frequency when not
loaded

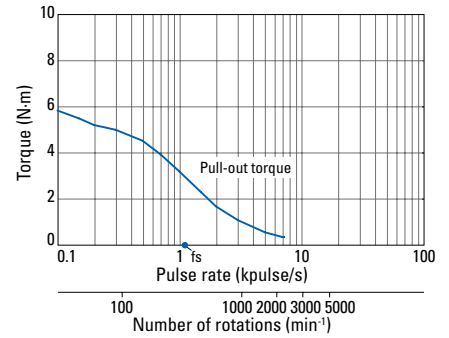

SH2862-5141
SH2862-5111

SM2862-5155
SM2862-5121

SM2862-5166

Constant current circuit
Source voltage: 100 VAC
Operating current:
4 A/phase, 2-phase
energization (full-step)
Pull-out torque:
 $J_L=15.3 \times 10^{-4} \text{kg}\cdot\text{m}^2$ (use the
rubber coupling)
fs: Maximum self-start
frequency when not
loaded

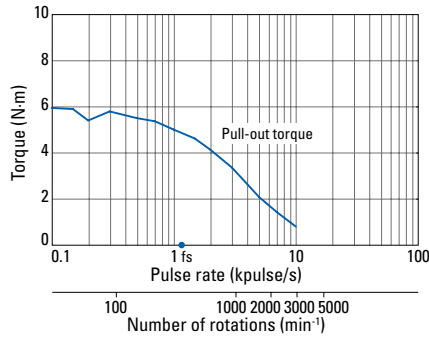

SH2862-5241
SH2862-5211

SM2862-5255
SM2862-5225

SM2862-5266

Constant current circuit
Source voltage: 100 VAC
Operating current:
6 A/phase, 2-phase
energization (full-step)
Pull-out torque:
 $J_L=15.3 \times 10^{-4} \text{kg}\cdot\text{m}^2$ (use the
rubber coupling)
fs: Maximum self-start
frequency when not
loaded

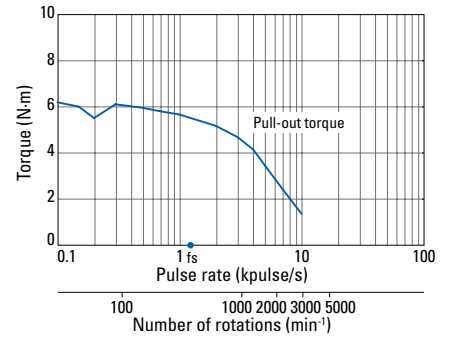

SH2863-5041
SH2863-5011

SM2863-5051
SM2863-5021

SM2863-5066

Constant current circuit
Source voltage: 100 VAC
Operating current:
2 A/phase, 2-phase
energization (full-step)
Pull-out torque:
 $J_L=44 \times 10^{-4} \text{kg}\cdot\text{m}^2$ (use the
rubber coupling)
fs: Maximum self-start
frequency when not
loaded

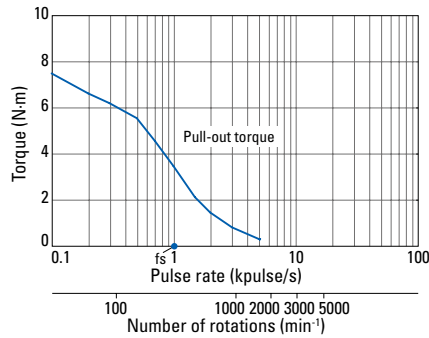

SH2863-5141
SH2863-5111

SM2863-5151
SM2863-5121

SM2863-5166

Constant current circuit
Source voltage: 100 VAC
Operating current:
4 A/phase, 2-phase
energization (full-step)
Pull-out torque:
 $J_L=44 \times 10^{-4} \text{kg}\cdot\text{m}^2$ (use the
rubber coupling)
fs: Maximum self-start
frequency when not
loaded

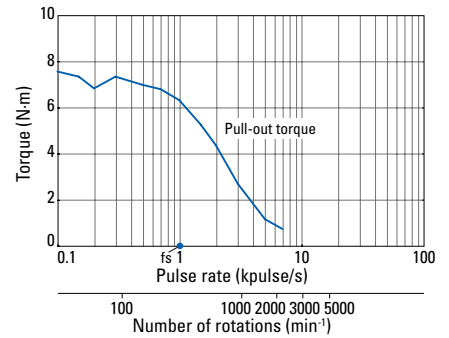

SH2863-5241
SH2863-5211

SM2863-5251
SM2863-5221

SM2863-5266

Constant current circuit
Source voltage: 100 VAC
Operating current:
6 A/phase, 2-phase
energization (full-step)
Pull-out torque:
 $J_L=44 \times 10^{-4} \text{kg}\cdot\text{m}^2$ (use the
rubber coupling)
fs: Maximum self-start
frequency when not
loaded

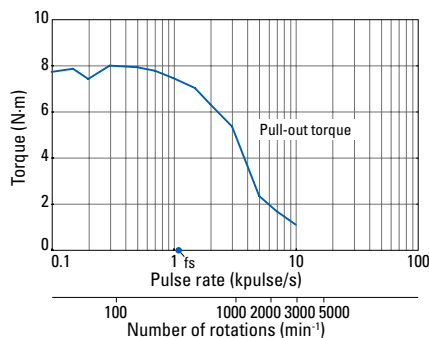

Dimensions (Unit: mm)

Lead wire type

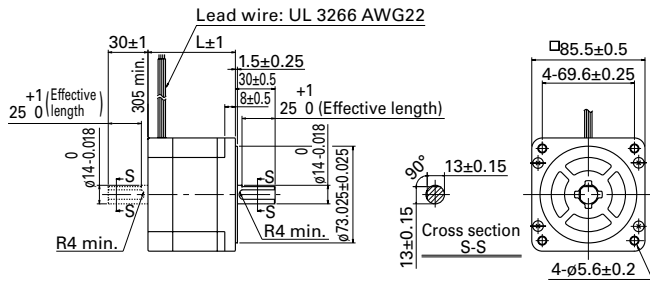

Terminal block type CE/UL model

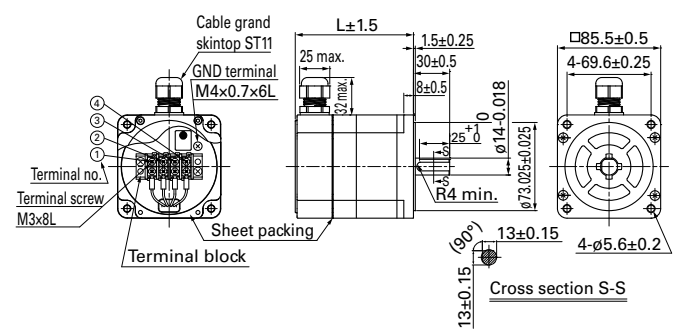

Lead wire type CE/UL model

Drawings for model numbers :

- SM2862-5155** 4A/phase single shaft
- SM2862-5255** 6A/phase single shaft
- SM2862-5225** 6A/phase dual shaft

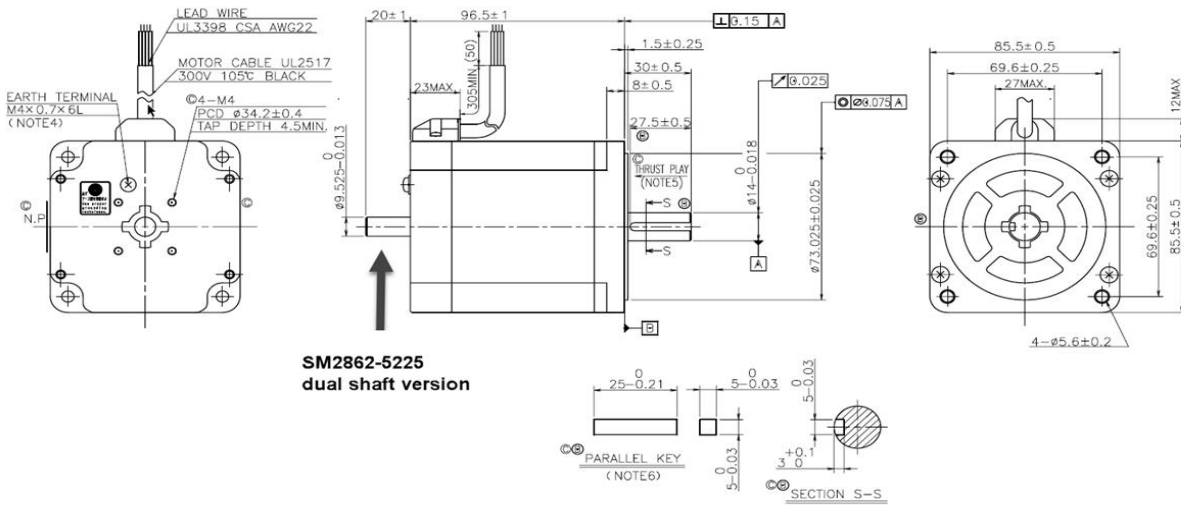

SM2862-5225
dual shaft version

Internal wiring

Lead wire type

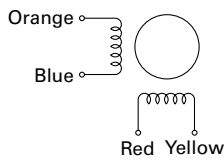

Terminal block type

() terminal block number

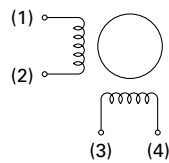

Compatible drivers

Driver is not included.

If you require assistance finding a driver, contact us for details.

ROHS

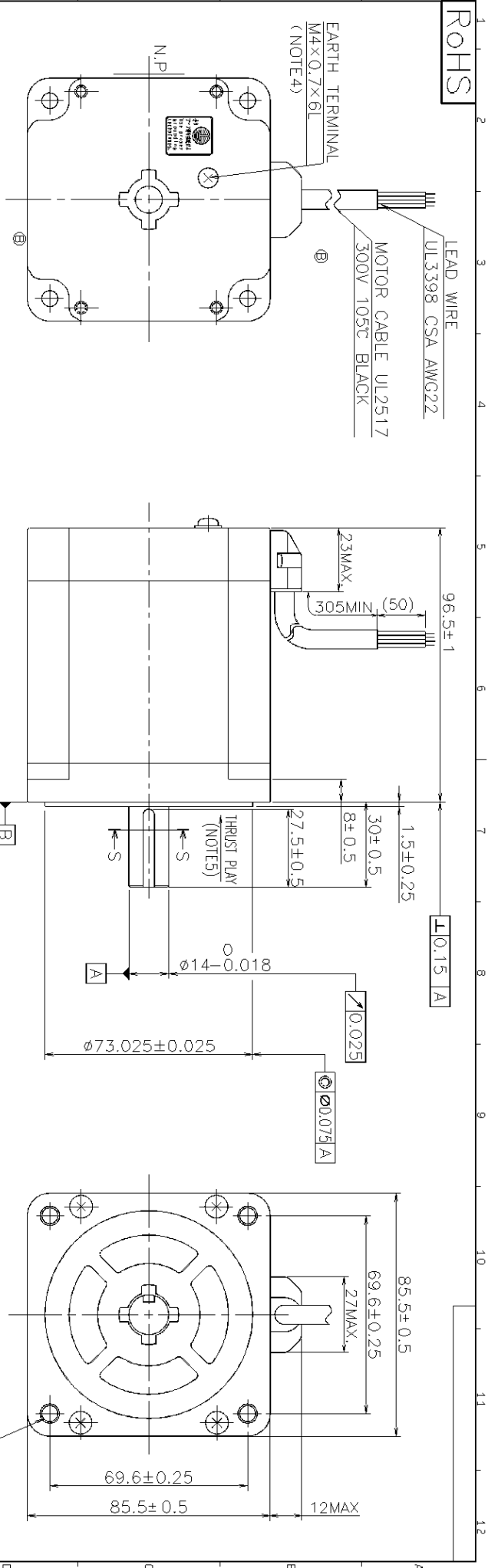

RATED CHARACTERISTICS (2EX.)

NOTE1 POWER INPUT 250 V(AC) MAX.

PHASES	2
FUNDAMENTAL STEP ANGLE	1.8 °
RATED VOLTAGE	3.32 V(DC)
AMPS	4 A/PHASE
WINDING RESISTANCE	0.83 Ω±10% at 25 °C
COIL INDUCTANCE	6.4 mH±20% at 1 kHz, 1 V(rms)
HOLDING TORQUE	6.4 N·m MIN. at I=4 A/PHASE 2EX.
NOTE2 PULL OUT TORQUE	4.7 N·m MIN. at 100 pulse/s INERTIAL LOAD 15.3x10 ⁻⁴ kg·m ² (INERTIA OF RUBBER COUPLING IS INCLUDED.)

NOTE2 MAX. STARTING RATE 850 pulse/s MIN. at NO LOAD

NOTE2 MAX. SLEWING RATE 1500 pulse/s MIN. at NO LOAD

NOTE3 COIL TEMPERATURE RISE ±0.09 ° (0.18 ° SPREAD MAX.) 2EX.

ROTOR INERTIA	3x10 ⁻⁴ kg·m ² NOMINAL
INSULATION CLASS	F (CLASS-F AS FOR UL RECOGNITION)
ALLOWABLE THRUST LOAD	60 N
ALLOWABLE RADIAL LOAD	200 N LOAD TO SHAFT END.
IP RATING	IP43 EN60034-5

NOTE1. DRIVER INPUT VOLTAGE.

NOTE2. SANVO STANDARD 2PHASE EXCITATION DRIVE CIRCUIT WAS USED. (PMM-BA-4804) E=100V(AC).

NOTE3. MOUNT A MOTOR ON 200X200X16 ALUMINIUM HEAT SINK AND ENERGIZE COIL

AT 2 PHASE. I=4 A/PHASE CONSTANTLY. MEASURED BY THE CHANGE OF RESISTANCE METHOD.

NOTE4. FASTENING TORQUE OF THE SCREWS SHOULD BE 1±0.1 N·m.

NOTE5. THRUST PLAY IS LESS THAN 0.3mm AT THRUST LOAD 60N.

NOTE6. ACCESSORY: PARALLEL KEY (5X5X25)

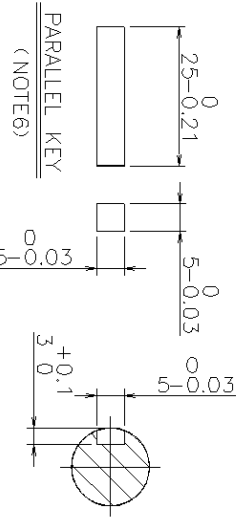

SECTION S-S

WHEN A MOTOR IS SEQUENCED AS SHOWN IN THE TABLE BELOW, THE SHAFT ROTATION MUST BE CLOCKWISE WHEN YOU SEE FROM SURFACE [B] SIDE.

STEP	LEADS COLOR			
	RED	BLUE	YELLOW	ORANGE
1	⊖	⊖	⊕	⊕
2	⊕	⊕	⊖	⊖
3	⊖	⊖	⊕	⊕
4	⊕	⊕	⊖	⊖

CONNECTION

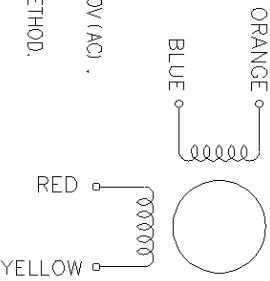

C	E0077605	06-06-13	06-06-13	APPROVED BY X. Matsuura	06-06-13	DATE	DATE
B	E0076987	06-05-22	MM	DESIGNED BY K. Kake	06-06-13	DATE	DATE
A	NEW DESIGN	06-03-23	RS	TEST REPORT BY D. Amano	06-06-13	DATE	DATE

山洋電気株式会社
SANVO DENKI CO., LTD.

SM2862-5155