



+5V/Adjustable CMOS Step-down Switching Regulator

MAX638

General Description

The MAX638 step-down switching regulator is designed for minimum component, low power, DC-DC conversion.

Typical applications require only a small, low-cost inductor, an output filter capacitor, and a catch diode. Low battery detection circuitry is included on chip.

Though most simply used as a fixed +5V output regulator, the MAX638 can be set for other voltages by adding 2 resistors.

Maxim manufactures a broad line of step-up, step-down, and inverting DC-DC converters, with features such as logic-level shutdown, adjustable oscillator frequency, and external MOSFET drive.

Applications

- Efficient DC-DC Step-Down Regulation
- Linear Voltage Regulator Replacement
- +12V to +5V Conversion
- Battery Life Extension
- Portable Instruments

Pin Configuration

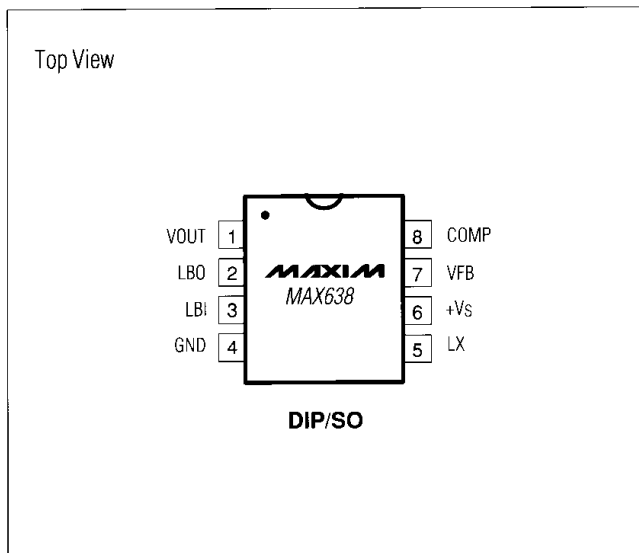

Features

- ◆ Fixed +5V Output
- ◆ Adjustable Output with 2 Resistors
- ◆ Low Operating Current
- ◆ 85% Typ Efficiency
- ◆ 8-Pin Plastic DIP and Narrow SO Packages
- ◆ 3 External Components
- ◆ Low Battery Detector

Ordering Information

PART	TEMP. RANGE	PIN-PACKAGE
MAX638ACPA	0°C to +70°C	8 Plastic DIP
MAX638ACSA	0°C to +70°C	8 Narrow SO
MAX638AC/D	0°C to +70°C	Dice
MAX638AEPA	-40°C to +85°C	8 Plastic DIP
MAX638AESA	-40°C to +85°C	8 Narrow SO
MAX638AMJA	-55°C to +125°C	8 CERDIP

Typical Operating Circuit

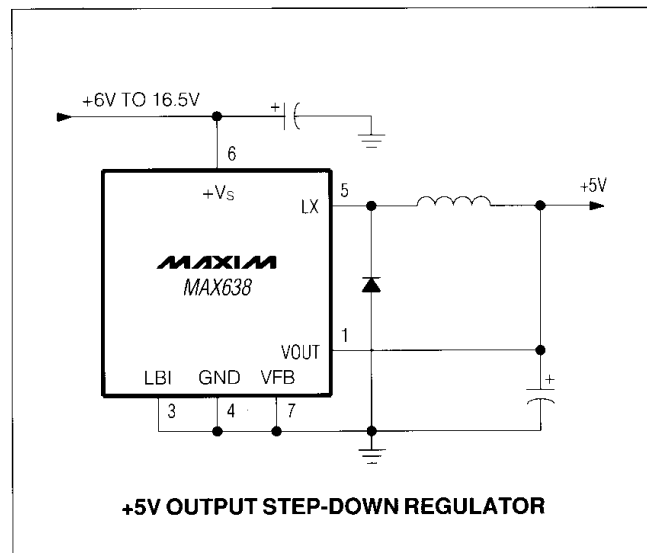

+5V/Adjustable CMOS Step-Down Switching Regulator

ABSOLUTE MAXIMUM RATINGS

Supply Voltage +Vs	±18V
Output Voltage +LX	±18V
Output Voltage LBO	+ Vs
Input Voltage LBO, LBI, VFB, COMP	-0.3V to (+Vs + 0.3V)
LX Output Current	525mA Peak
LBO Output Current	50mA
Operating Temperature	
MAX638AC	0°C to +70°C
MAX638AE	-40°C to +85°C
MAX638AM	-55°C to +125°C

Storage Temperature	-65°C to +160°C
Lead Temperature (Soldering, 10 sec.)	+300°C
Power Dissipation	
Plastic DIP (derate 8.33mW/°C)	625mW
Small Outline (derate 6mW/°C)	450mW
CERDIP (derate 8mW/°C above +50°C)	800mW

Stresses beyond those listed under "Absolute Maximum Ratings" may cause permanent damage to the device. These are stress ratings only, and functional operation of the device at these or any other conditions beyond those indicated in the operational sections of the specifications is not implied. Exposure to absolute maximum rating conditions for extended periods may affect device reliability.

ELECTRICAL CHARACTERISTICS

(+Vs = +12V, TA = +25°C, unless otherwise noted.)

PARAMETER	SYMBOL	CONDITIONS	MIN	TYP	MAX	UNITS
Supply Voltage	+Vs	Over Temperature V _{OUT} = +5V Adjustable mode	5 2.2		16.5 16.5	V
Supply Current	I _S	TA = +25°C Over Temperature		135 180	600	μA
Reference Voltage (Internal)		TA = +25°C Over Temperature	1.28 1.24	1.31	1.34 1.38	V
V _{OUT} Voltage (Note 1)		No Load, V _{FB} = GND, Over Temperature	4.75	5.0	5.25	V
Efficiency				85		%
Line Regulation (Note 1)		+10V < +Vs < +15V		0.2		% V _{OUT}
Load Regulation (Note 1)		P _{OUT} = 0mW to 150mW		0.2		% V _{OUT}
Oscillator Frequency	f _O			65		kHz
Oscillator Duty Cycle				50		%
LX ON Resistance	R _{ON}	I _X = 100mA		6	12	Ω
LX Leakage Current	I _{XL}	V _S = 0V TA = +25°C Over Temperature		0.01	1.0 30	μA
V _{FB} Input Bias Current	I _{FB}			0.01	10	nA
Low Battery Input Threshold	V _{LBI}			1.31		V
Low Battery Input Bias Current	I _{LBI}			0.01	10	nA
Low Battery Output Current	I _{LBO}	V ₂ = +0.4V, V ₃ = +1.1V TA = +25°C Over Temperature	0.5	1.0		mA
Low Battery Output Leakage Current	I _{LBOL}	V ₂ = +Vs, V ₃ = +1.4V		0.01	3.0	μA

Note 1: Guaranteed by correlation with DC pulse measurements.

+5V/Adjustable CMOS Step-Down Switching Regulator

MAX638

Pin Description

PIN	NAME	FUNCTION
1	VOUT	The sense INPUT for fixed +5V output operation. VOUT, is internally connected to the on-chip voltage divider. Although it is connected to the output of the DC-DC converter (Figure 2), the VOUT pin does not supply current, LX does.
2	LBO	Low Battery Detector Output. An open drain N-channel MOSFET which sinks current when the voltage at LBI is below +1.31V.
3	LBI	Low Battery Detector Input. When the voltage at LBI is lower than the Low Battery Detector threshold (+1.31V), LBO sinks current.
4	GND	Ground

PIN	NAME	FUNCTION
5	LX	This pin drives the external inductor with an internal P-channel power MOSFET. LX has an output resistance of typically 6Ω and a peak current rating of 525mA.
6	+VS	The input voltage, from VOUT to +16.5V.
7	VFB	When VFB is grounded, the DC-DC converter output will be +5V. When an external voltage divider is connected from VOUT to VFB, this pin becomes the feedback input for adjustable output operation.
8	COMP	The Compensation input is connected to the internal voltage divider which sets the fixed voltage output. It is normally left unconnected. In some circuit board layouts, a lead compensation capacitor (100pF to 10nF) connected between VOUT and COMP reduces low-frequency ripple and improves transient response.

Typical Operating Characteristics

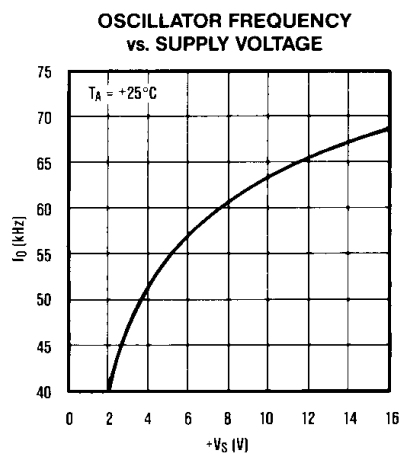
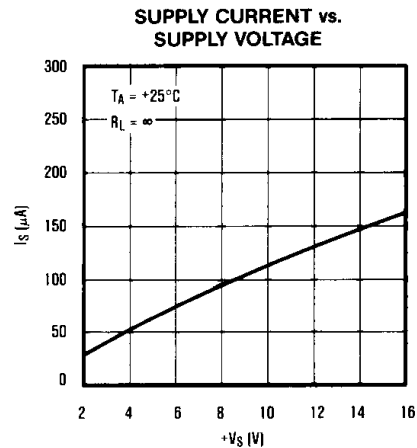
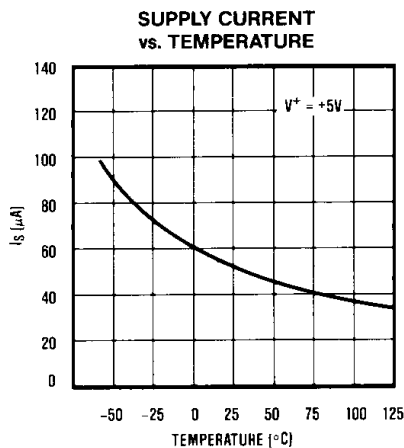
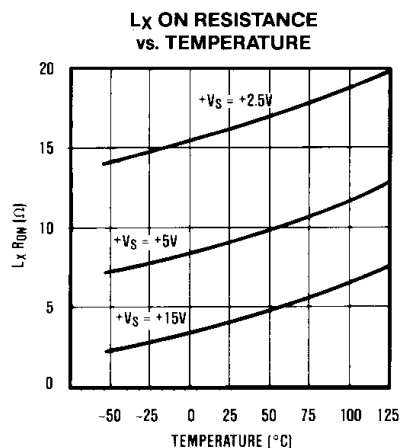

+5V/Adjustable CMOS Step-Down Switching Regulator

Detailed Description

Basic Operation

Figure 1 shows a simplified step-down DC-DC converter. When the switch closes, a charging current flows through the inductor creating a magnetic field. (This current flows into the filter capacitor and load as well.) When the switch opens, the current continues to flow through the inductor in the same direction as the charging current. But since the switch is now open, the current must flow through the diode. With the switch open, the inductor alone supplies current to the load. This current linearly decays to zero as the magnetic field collapses and the energy in the core of the inductor is transferred to the filter capacitor and load.

Figure 2 shows a block diagram of the MAX638 and a typical connection in which a +9V input is converted to a +5V output with 85% efficiency. When the output drops below +5V, the Error Comparator switches high and connects the internal 65kHz oscillator to the gate of the LX output driver. LX turns on and off at the clock frequency, charging and discharging the inductor and supplying current to the output as described above. When the output voltage reaches +5V, the comparator output goes low and the inductor is no longer pulsed.

Basic Step-Down Circuits

Table 1 shows nominal inductor parameters for a variety of input voltages. The data refers to the circuit of Figure 3.

Output Driver (LX Pin)

A large P-channel MOSFET with an on resistance of approximately 6Ω is used to charge the inductor. It is internally connected between $+V_S$ and LX and has a peak current rating of 525mA. The available output current for most applications will be less than the peak current rating. A good rule of thumb for MAX638 maximum output current is:

$$4 I_{OUT} < 525\text{mA}, \text{ assuming } V_{IN} \approx 2 V_{OUT}$$

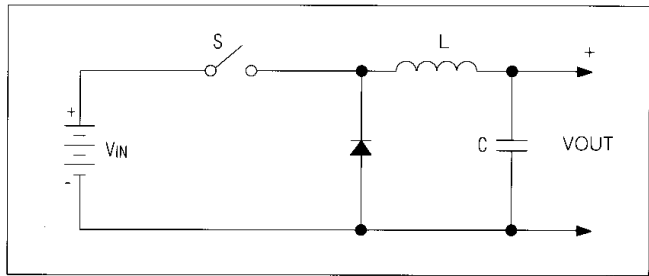

Figure 1. Simplified Step-Down Converter

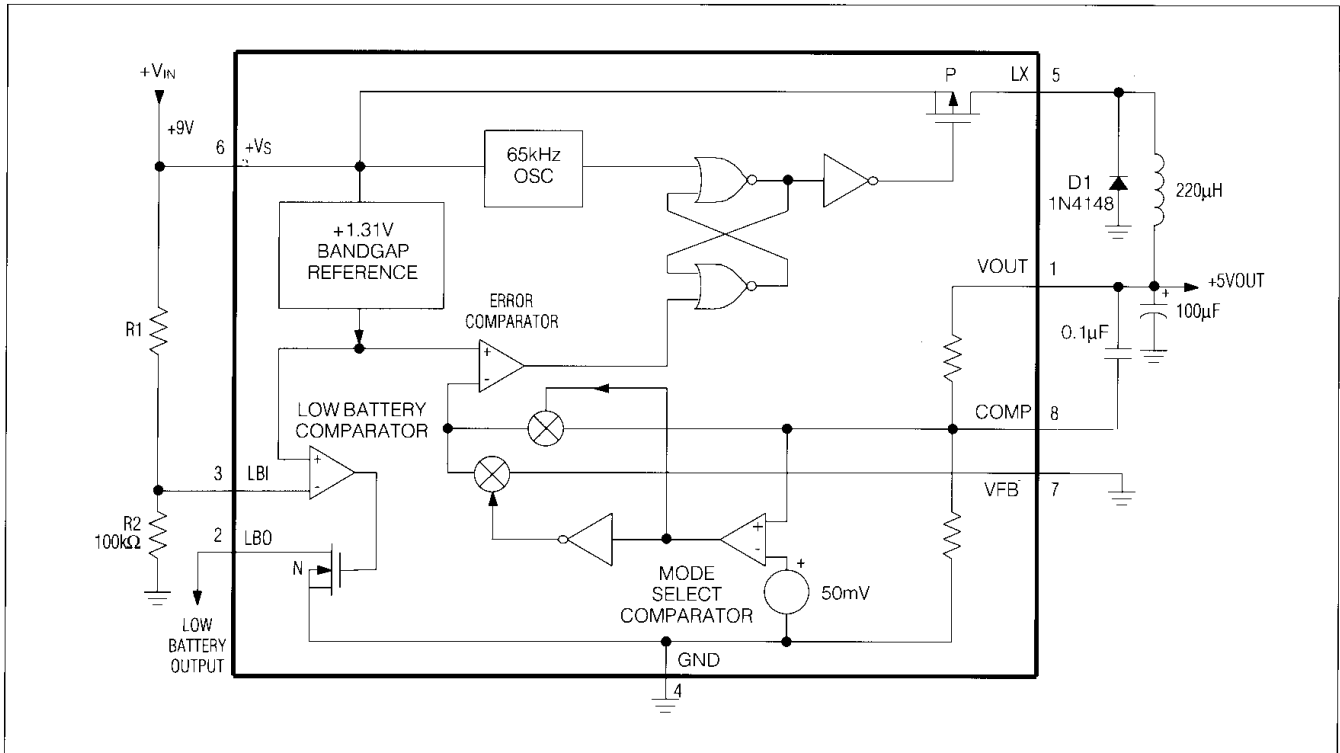

Figure 2. MAX638 Block Diagram and Typical Circuit

+5V/Adjustable CMOS Step-Down Switching Regulator

Table 1. Inductor Selection For Common Designs (See Figure 3)

MAXIM PART NO.	VIN (V)	VOUT (V)	IOUT (mA)	TYP EFF (%)	IPK (mA)	INDUCTOR (L)	
						μH	Ω
MAX638	7-9.5	5	35	92	200	150	0.4
	8-9.5	5	55	89	200	150	0.4
	10-14	5	50	92	300	270	0.6
	12	5	60	92	250	270	0.6
	12	5	75	89	300	180	0.5

Fixed or Adjustable Output

For operation at the preset +5V output voltage, VFB is connected to GND, and no external resistors are required. For other output voltages, an external voltage divider is connected to VFB as shown in Figure 4. The output is set by R3 and R4 as follows:

Let R4 be any resistance in the 10kΩ to 10MΩ range, typically 100kΩ, then:

$$R3 = R4 \left(\frac{V_{OUT}}{1.31V} - 1 \right)$$

Low Battery Detector

The Low Battery Detector compares the voltage on the Low Battery Input (LBI) with the internal +1.31V bandgap reference. The Low Battery Detector Output (LBO) goes low whenever the input voltage at LBI is less than +1.31V. The Low Battery detection voltage is set by resistors, R1 and R2 (Figure 2).

Let R2 be any resistance in the 10kΩ to 10MΩ range, typically 100kΩ, then:

$$R1 = R2 \left(\frac{V_{LB}}{1.31V} - 1 \right) \quad (V_{LB} \text{ is the desired Low Battery detection voltage})$$

What Value of Inductor?

A General Discussion

The converter in this data sheet operates by charging an inductor from a DC input, and then discharging the inductor to generate a DC output less than the input.

The proper inductor for any DC-DC converter depends on three things: the desired output power, the input voltage (or input voltage range), and the converter's oscillator frequency and duty cycle. The oscillator timing is important because it determines how long the coil will be charged during each cycle. This and the input voltage determines how much energy will be stored in the coil.

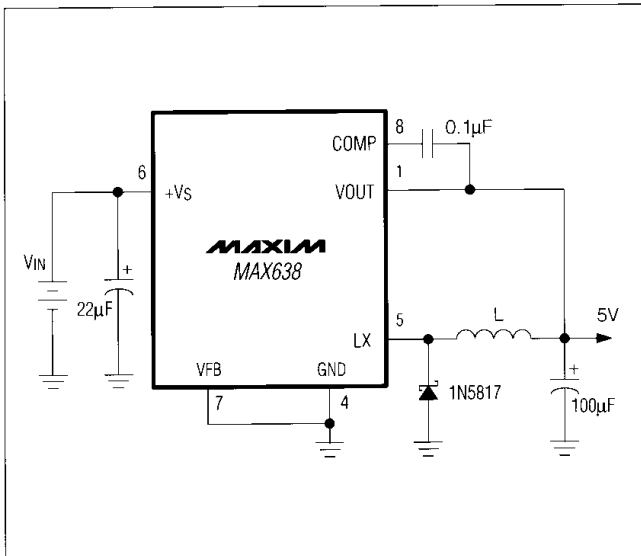

Figure 3. Typical Operating Circuit (Table 1)

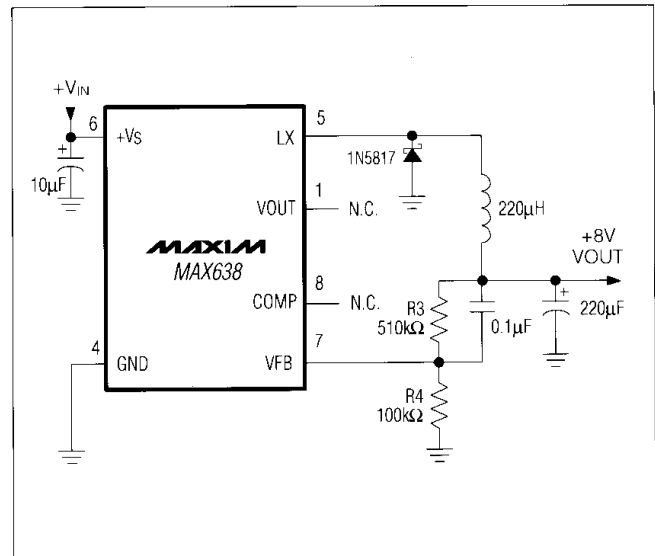

Figure 4. Adjustable Output Operation

+5V/Adjustable CMOS Step-Down Switching Regulator

The inductor must meet four electrical criteria:

[] **Value-** Low enough inductance so it stores adequate energy at the worst-case, low input voltage.

High enough so excessive and potentially destructive currents are avoided under worst-case high conditions for power-switch transistor on time and high input voltage.

[] **Saturation-** The coil must deliver the correct inductance value at the worst-case, high peak operating current.

[] **EMI-** Electromagnetic interference must not upset nearby circuitry or the regulator IC. Ferrite bobbin types work well for most digital circuits; toroids or pot cores work well for EMI-sensitive analog circuits.

[] **DC resistance-** Winding resistance must be adequately low so efficiency is not affected and self-heating does not occur. Values less than 2Ω are usually more than adequate.

Other inductor parameters, such as core loss or self-resonant frequency, are not a factor at the relatively low MAX638 operating frequency.

Inductor Value- Low Enough?

The problem that bites designs most often, especially in the production or pre-production phase, happens when the inductor value is too high. These units fail to deliver enough load current and exhibit poor load regulation. The worst case is:

- [] Maximum load current
- [] Minimum supply voltage
- [] Maximum inductor value, including tolerance
- [] Maximum on resistance of the switch because it reduces the excitation voltage across the inductor
- [] Worst-case low on time

Inductor Value- High Enough?

The inductor value must be high enough so peak currents do not stress the transistor or cause the inductor core to saturate. Odd symptoms can be traced to excessive inductor currents: low efficiency, rattling heat sinks, whining coils, and increased output ripple. Very low inductor values can result in damaged power transistors.

The slope of the inductor current, and therefore the peak value that it reaches in a given on time, is determined by the supply voltage and the inductor value. The worst case occurs at:

- [] Maximum supply voltage
- [] Minimum inductor value, including tolerance
- [] Minimum on resistance of the switch
- [] Low switching frequency (or maximum switch on-time)

Inductor Selection

The inductor equations below must be calculated for both worst-case sets of conditions. The final value chosen should be between the minimum value and maximum value calculated. Within these bounds, the value can be adjusted slightly lower for extra load capability or higher for low ripple.

$$[1] \quad I_{pk} = \frac{4 I_{OUT}}{\frac{V_{IN} - V_{SW} - V_{OUT}}{V_{OUT} - V_{DIODE}} + 1}$$

$$[2] \quad L = \frac{V_{IN} - V_{SW} - V_{OUT}}{I_{pk}} (t_{ON})$$

where V_{SW} is the voltage drop across the switch in the on state. Conservatively, the worst case is about 0.75V max, 0.25V min with $V_{IN} = +15V$ and 1.5V max, 0.5V min with $V_{IN} = +5V$.

Example: A +12V 10% input must be converted to +5V at 50mA. A Schottky diode (1N5817) and a MAX638A are used.

Calculate the maximum inductor value allowed:

$$I_{pk} = \frac{(4) (50mA)}{\frac{10.8V - 0.75V - 5V}{5V - 0.4V} + 1} = 95mA$$

$$L = \frac{10.8V - 0.75V - 5V}{95mA} (6\mu s) = 319\mu H$$

Calculate the minimum inductor value allowed:

$$I_{pk} = 525mA \text{ (from table of max ratings)}$$

$$L = \frac{13.2V - 0.25V - 5V}{525mA} (9.2\mu s) = 139\mu H$$

The standard value of 270 μ H would be a good choice for this application.

Output Filter Capacitor

The MAX638's output ripple has two components which are 90° out-of-phase. One component results from the change in the stored charge on the filter capacitor with each LX pulse. The other is the product of the capacitor's charge-discharge current and its Equivalent Series Resistance (ESR). With low-cost aluminum electrolytic capacitors, the ESR-produced ripple is often larger than that caused by the change in charge. Consequently, high-quality aluminum or tantalum filter capacitors will minimize output ripple, even if smaller capacitance values are used. Best results at a reasonable cost are

+5V/Adjustable CMOS Step-Down Switching Regulator

typically achieved with a high-quality aluminum electrolytic, in the 100 μ F to 500 μ F range, in parallel with a 0.1 μ F ceramic capacitor.

Table 2. Component Suppliers

COMPANY	PHONE	FAX
Coiltronics	USA (407) 241-7876	(407) 241-9339
Coilcraft	USA (708) 639-6400	(708) 639-1469
Dale	USA (402) 564-3131	(402) 563-1841
Sumida	USA (708) 956-0666 Japan 81-3-3607-5111	(708) 956-0702 81-3-3607-5144

External Diode

The most MAX638 circuits, the current in the external diode (D1, Figure 2) abruptly goes from zero to its peak value each time LX switches off. To avoid excessive losses, the diode must have a fast turn-on time. For low-power circuits with peak currents less than 100mA, signal diodes such as 1N4148s perform well. For higher power circuits, or for maximum efficiency at low power, the 1N5817 series of Schottky diodes is recommended. Although 1N4001s and other general-purpose rectifiers are rated for high currents, they are unacceptable because their slow turn-on time results in excessive losses.

Application Hints

Inductor Saturation

When using off-the-shelf inductors, make sure that their peak current rating is observed. When designing your own inductors, observe the core manufacturer's Ampere-turns or NI ratings. Failure to observe the peak current or NI ratings may lead to saturation of the inductor, especially in circuits with external boost transistors. Inductor saturation leads to very high current levels through the power switching device, causing excessive power dissipation, poor efficiency, and possible damage.

Test for saturation by applying the maximum load and the maximum input voltage while monitoring the inductor current with a current probe. The normal inductor current waveform is a sawtooth with a linear current ramp. Saturation creates a nonlinear current waveform with a very rapid increase in current once the inductor saturates.

Bypassing and Compensation

Since the inductor charge and discharge currents can be relatively large, high currents may flow in ground connections near the MAX638. To prevent unwanted feedback, the impedance of the ground path must be as low as possible, and power-supply bypassing should be used. A 10 μ F aluminum electrolytic placed at the device pins is recommended.

When the value of the voltage setting resistors (R3 and R4, Figure 4) exceeds 50k Ω , stray capacitance at the VFB input can add a "lag" to the feedback response, increasing low-frequency ripple and lowering efficiency. This problem can often be avoided by minimizing lead lengths and circuit board trace size at the VFB node. It can also be remedied by adding a "lead" compensation capacitor (100pF to 0.1 μ F) in parallel with R3.

MAX638

MAX638

+5V/Adjustable CMOS Step-Down Switching Regulator

Maxim cannot assume responsibility for use of any circuitry other than circuitry entirely embodied in a Maxim product. No circuit patent licenses are implied. Maxim reserves the right to change the circuitry and specifications without notice at any time.

8 _____ **Maxim Integrated Products, 120 San Gabriel Drive, Sunnyvale, CA 94086 408-737-7600**

© 1996 Maxim Integrated Products

Printed USA

MAXIM is a registered trademark of Maxim Integrated Products.