



Specification of Control Board

(RGB, DVI, HDMI & Video supportable)

Model Name : Venus

Part No. : VNS-ADVH-NL12280BC20-05D

February 2014

Revision History

PCB Version	Rev. date	Revision Details
1.0	Dec 2011	Initial Version issue
1.0	Feb 15, 2012	31 kinds of LCD panels adopted (firmware setting)
1.0	Feb 17, 2012	32 kinds of LCD panels adopted (firmware setting)
1.0	Feb 28, 2012	34 kinds of LCD panels adopted (firmware setting)
1.0	Mar 20, 2012	36 kinds of LCD panels adopted (firmware setting)
1.0	Mar 29, 2012	Typing error correction 10.1 RS-232 Serial control - Baud rate : changed from 9600 to 38400 10.3 RS-232 Serial control (Table) - OSD Timeout : added "off" - Sleep Timer : added "1 minute "
1.0	May 14, 2012	57 kinds of LCD panels adopted (firmware setting)
1.0	June 15, 2012	67 kinds of LCD panels adopted (firmware setting)
1.0	July 05, 2012	74 kinds of LCD panels adopted (firmware setting)
2.0	July 19, 2012	79 kinds of LCD panels adopted (firmware setting)
2.0	Aug 16, 2012	89 kinds of LCD panels adopted (firmware setting)
3.0	Sept 03, 2012	HDMI Type : J2(SMT) → J2(DIP) Volume Control Connector added : It depends on LCD panels 6.2.13 Audio Volume Control : CN12 (Depends on LCD – if not, tooling cost needed) 'Backlight ON/ OFF' is strengthened : R163 : 4.7kohm adapted Panel VCC 3.3 is strengthened: L7(470) → L7(100) Color of RGB Input Connector(J5) : Blue → Black
3.0	Sept 27, 2012	98 kinds of LCD panels adopted (firmware setting)
4.0	Dec 10, 2012	Hardware change - Dip type --> SMT type Reinforcement of Power Circuit for low twmp. resistance
4.0	Feb 25, 2013	page 17~18 : update the 24VDC/DC Converter page 19~22 : update the RS232 Protocol & Command page 23 : addition of Jumper option : 11.2.3 Luminance Option for AUO15"(G150XG01-V3), LG10.1"(LD101WX1-SL01) 134 kinds of LCD panels adopted (firmware setting)
5.0	Mar 15, 2013	LVDS 5V circuit change (reinforcement) 138 kinds of LCD panels adopted (firmware setting)
5.0	Oct 31, 2013	164 kinds of LCD panels adopted (firmware setting)
5.0	Feb 26, 2014	178 kinds of LCD panels adopted (firmware setting)

Contents

1.	Spec Summary -----	4
-----------	---------------------------	----------



2. General Description -----	4
3. Block Diagram -----	5
4. Dimension & Picture (Main Board) -----	6~7
5. Dimension & Picture (OSD Board) -----	8~10
6. Pin information -----	10~12
7. Setup for Operation (OSD) -----	13~15
8. Applicable Graphic Mode -----	16
9. Appendix – A (Option : 24V DC Power Board) ---	17~18
10. Appendix – B (Option : 24V DC Power Board Audio board)-----	19~21
11. Appendix – C (Option : RS232C Protocol) -----	22 ~25
12. Appendix – D ----- (Jumper switches, Dip switched Settings & supportable panel List)	26

The information presented in this document may form a part of quotation or contract under the agreement of both parties. Otherwise, this datasheet is subject to change without notice.



1. Spec Summary

- State of the art high performance picture quality
- Analog RGB / DVI / HDMI / CVBS
- Full CRT multi-sync monitor compatibility
- Multi-sync capability up to WUXGA resolution @ 60Hz, compatible standard
- DOS, VGA, SVGA, XGA and SXGA / WUXGA VESA timing
- Expand DOS, VGA and SVGA to full screen display
- True color(16.7 M) data processing and display driving
- Single control operated On-Screen-Display(hereafter "OSD") user interface
- Full control of all relevant display and interface parameters via OSD
- Multi language support(5 Language and more(Optional))
- VESA DDC 1/2B compliant
- Compatible with VESA DPMS power saving modes
- Small form factor: 140 x 100 x 20 mm
- Operating temperature: 0 to 45°C
- Multi-standard color system at CVBS (PAL / NTSC)
- Image **Flip** / **Mirror** supportable by AD board
- Serial Control (RS232C) ready / Customized protocol setting (optional contract basis)
- Audio support (2W x 2W speaker out) by separate daughter board (GH522A made by Green C&C Tech)
- Power: 12V DC Power adaptor, SMPS (Optional select)

2. General Description

This AD Board is an advanced TFT LCD Monitor Control Board. This design enables a full conventional CRT monitor & AV Monitor replacement with a large size Active Matrix LCD module. It is suitable for video resolution up to WUXGA @ 60Hz in all video modes; the full display area of the module is used. The design is implemented as a single printed circuit board.

As this AD board is designed to act as a full monitor interface. Besides the main functionality of an analog and Video, DVI, HDMI also various appealing On-Screen-Display Menu layouts are possible on customer's request.

This AD board is designed to support various TFT LCDs under the WUXGA resolution by BIOS option, customer's line-up their monitors with their own identity with following options.

3. Block Diagram

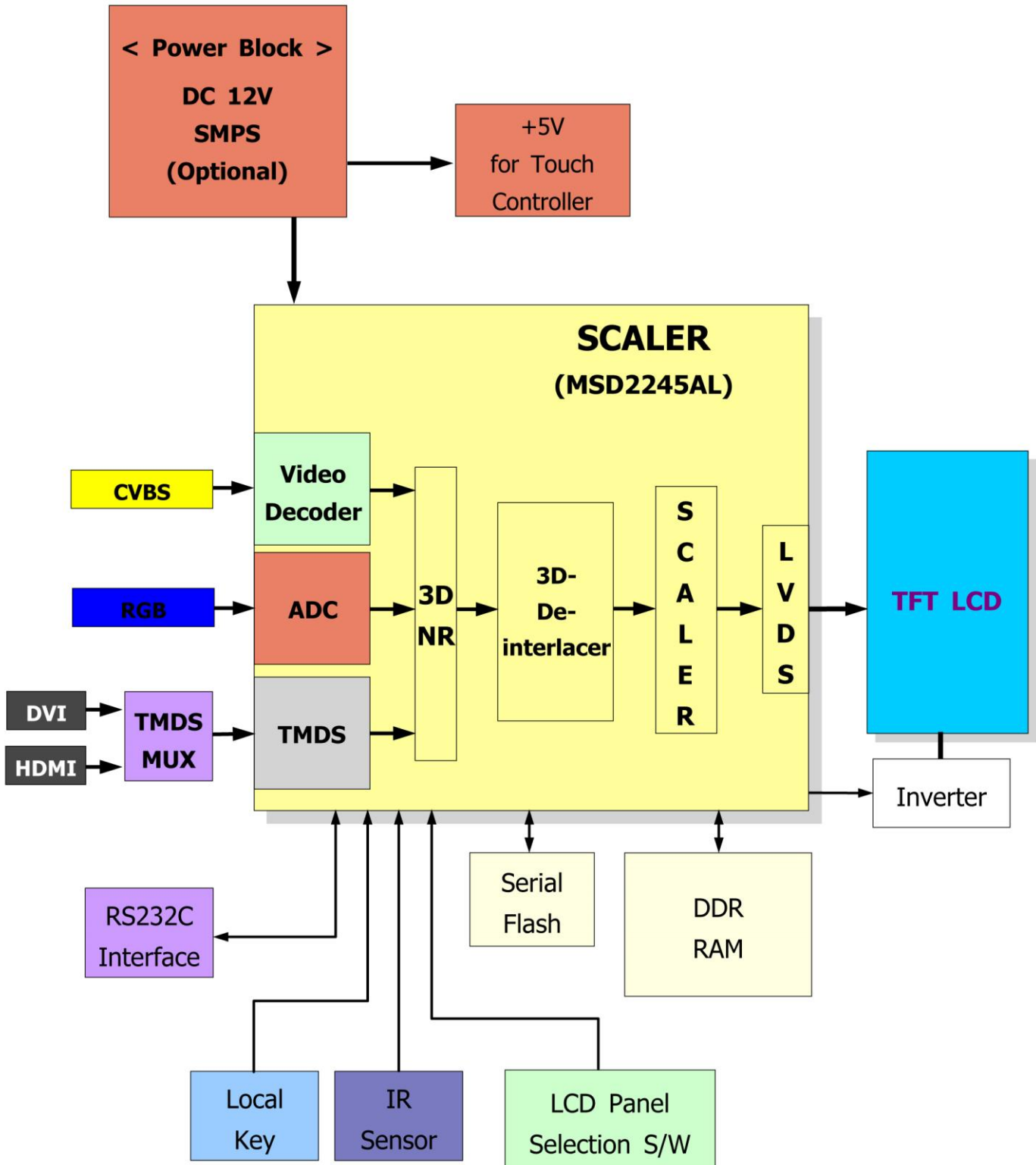



4. Dimension and Pictures - Main Board

4.1 Main Board (140 x 100 mm)

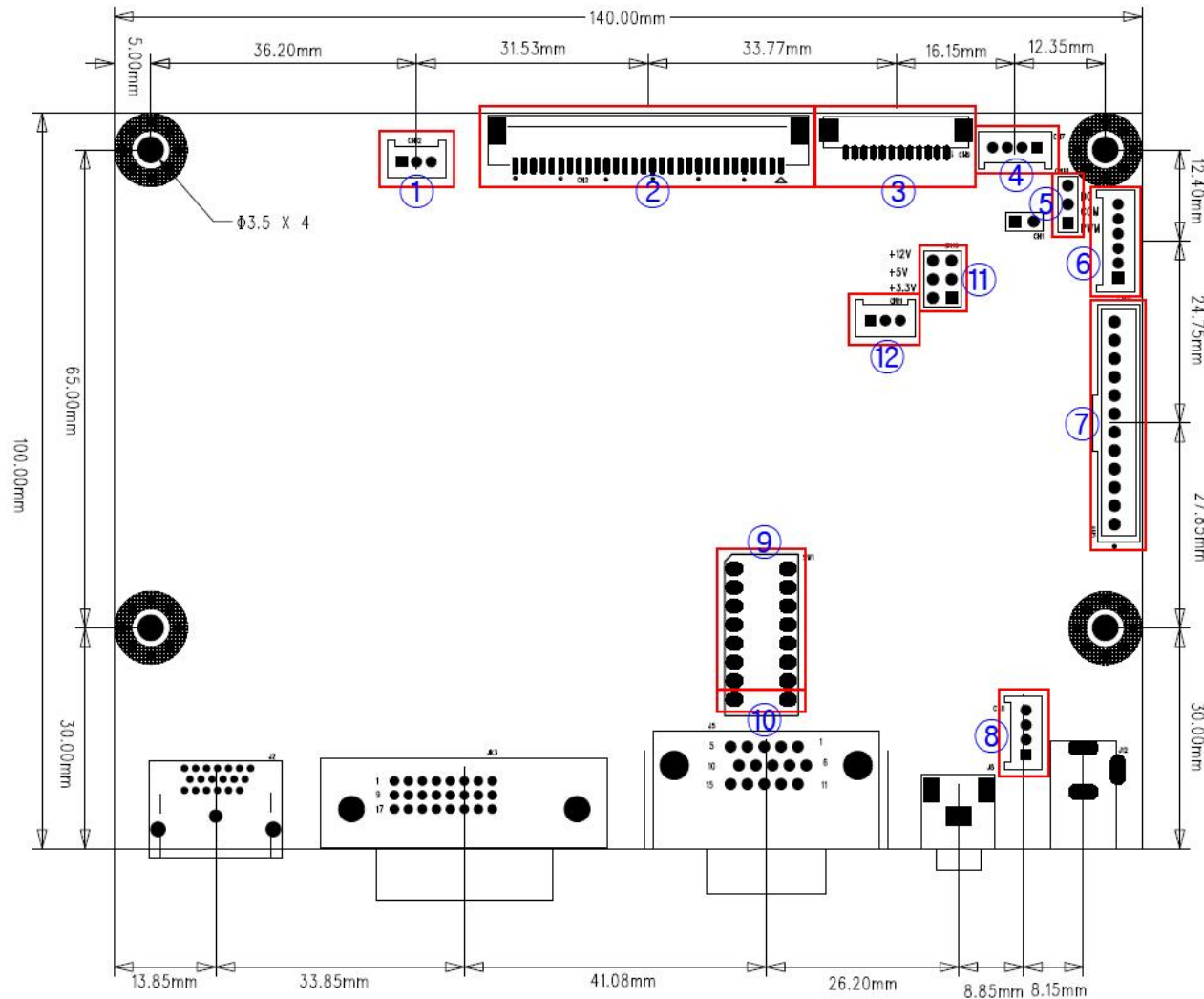

no	CON	Service
1	CN12	Audio Volume Controller
2	CN2	LVDS to LCD Panel
3	CN9	OSD
4	CN7	Touch Power Controller
5	CN18	Selection Jumper for the type of inverter diming
6	CN10	Inverter
7	CN6	12V DC from SMPS or System Power
8	CN8	RS232 Serial Connector
9	SW1	LCD Panel Selection Switch
10	SW1	LVDS Format Selector (JEIDA or VESA)
11	CN15	LCD Panel Vcc (3.3 / 5 / 12 volt) Selection Jumper
12	CN11	Juke box Control



4.2 Main Board Picture

Plan View

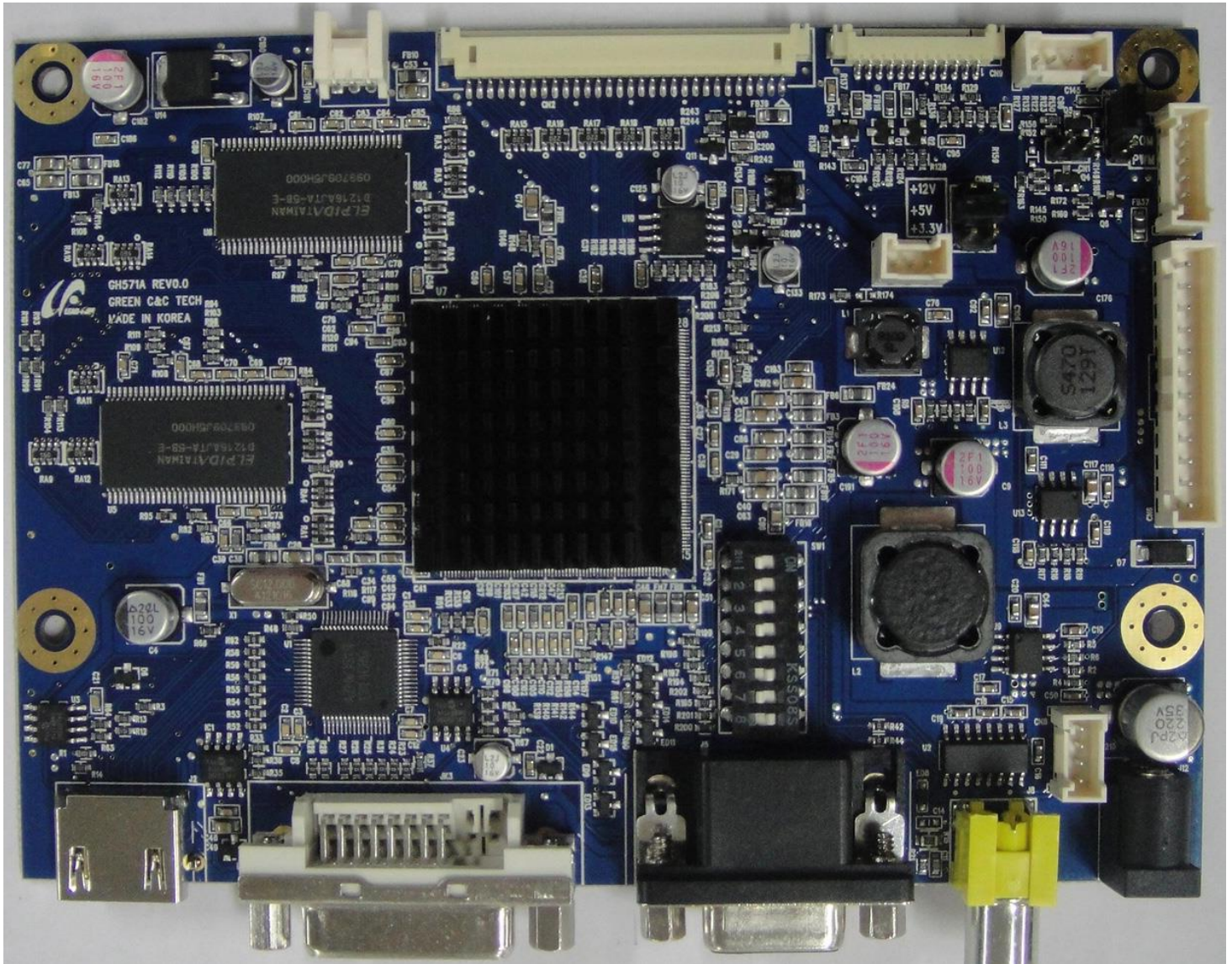

Front View

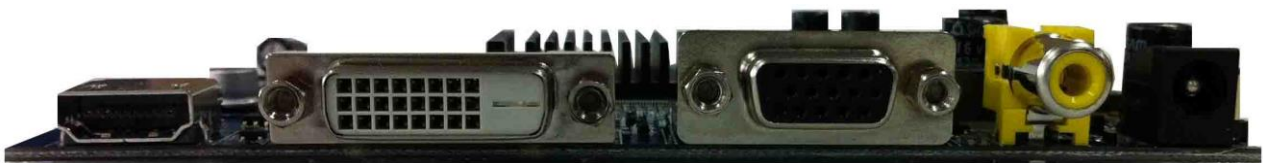

5. Dimension and Pictures - OSD Board

5.1 5Key OSD Board Type 1 : (108.9 x 19.5 mm)

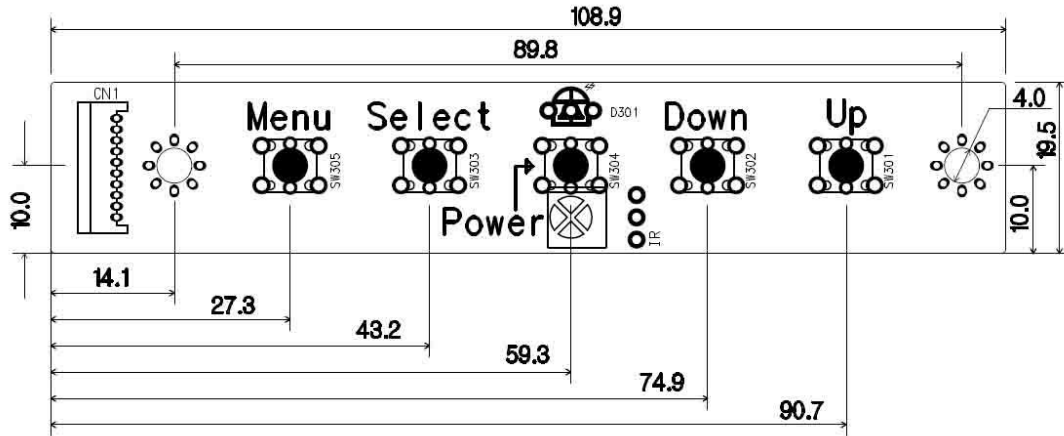

Standard model for board kit solution

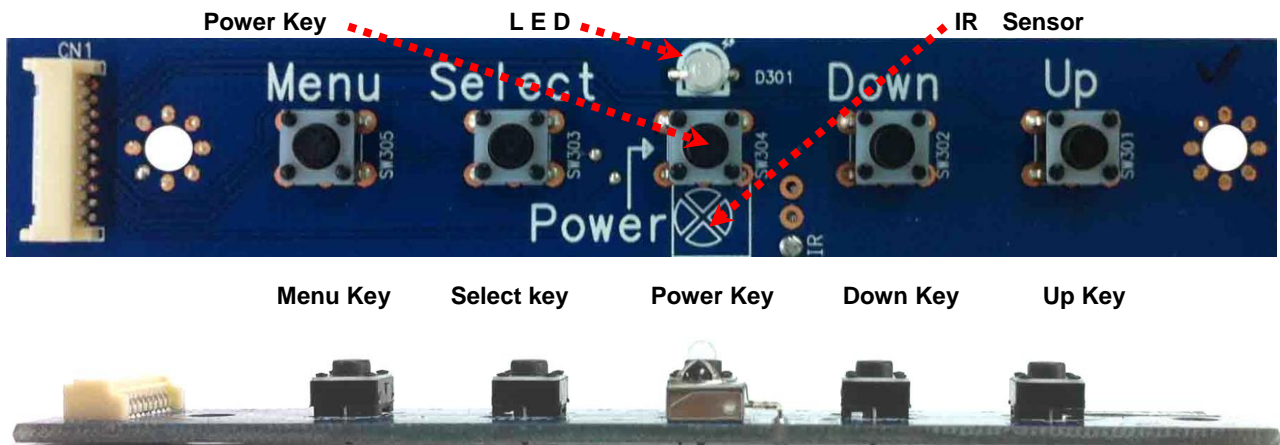

5.2 5Key OSD Board Type 2 : (127.0 x 20.0 mm)

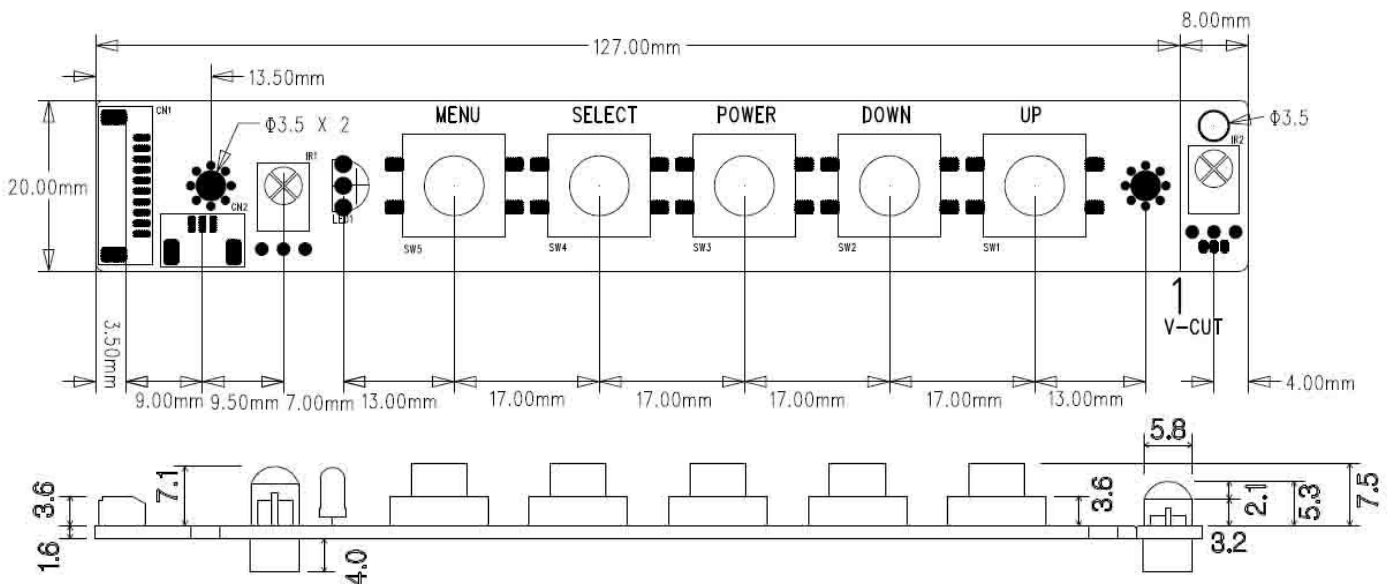



Option model for Open Frame or complete set solution

The OSD PCB consists of all in one type and split I/R sensor part.
In case of split type, the user can make it two different parts by cut easily.
(the boarder line between OSD body and split I/R sensor part was made by half cut condition)

All in one type - I/R Sensor and OSD PCB

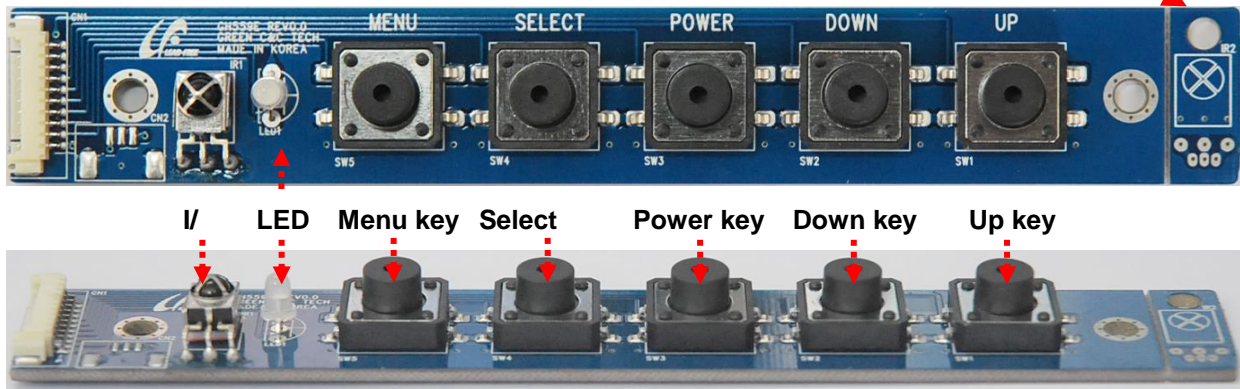

Split Type – separative I/R sensor

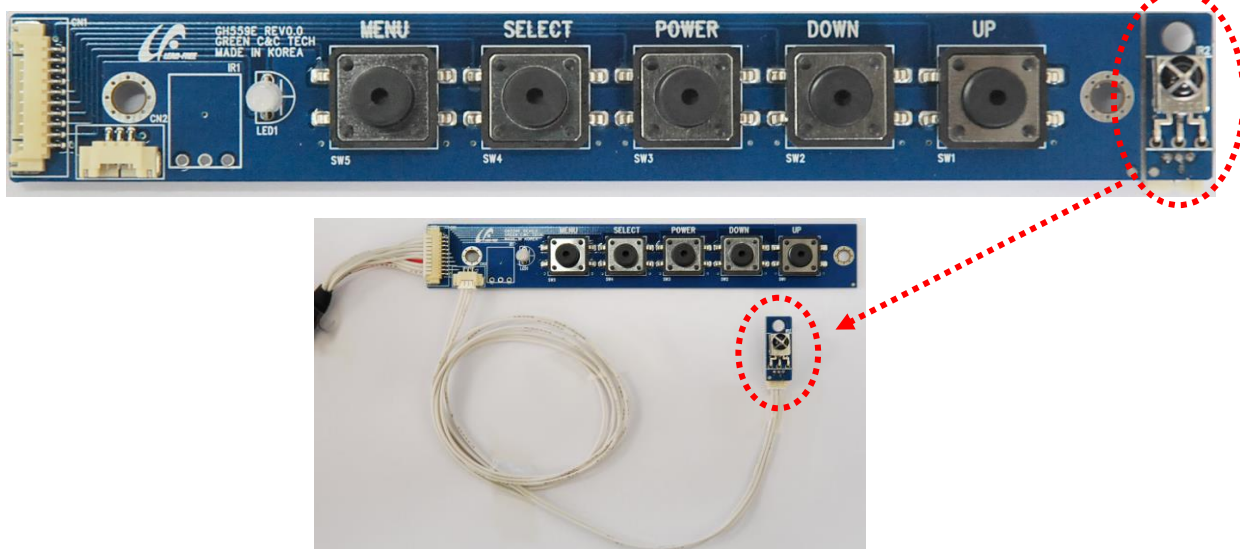

Laminate Sticker for fine finishing the open frame or complete set (option)

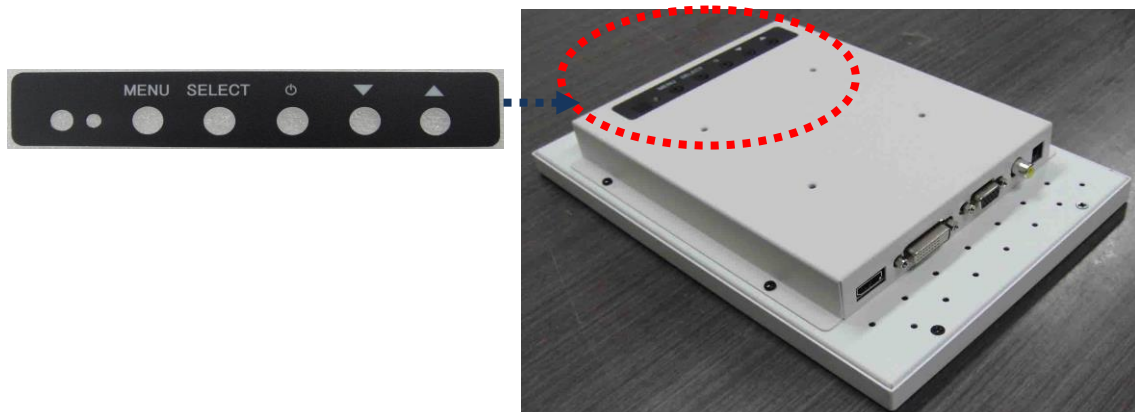



6. Connectors and Pin information

6.1 Connectors Summary

Service	Maker	Part number	Description	Point / Mating Housing
LCD I/F (LVDS)	Yeon-Ho	12507WR-30P	1.25mm, 30p SMD	CN2 / 12507HS-30
DVI IN		DVI 24+1, R/A	DVI-D, Right Angle	Standard DVI cable(Male)
HDMI IN		51L019S-333N	Right Angle	Standard HDMI cable(Male)
VGA		DB15	Right Angle	Standard VGA cable(Male)
C-VBS IN		RCA-102		Standard RCA cable(Male)
RS232C I/F Wafer	Yeon-Ho	SMW200-04	2.0mm, 4P, S/T	CN8 / SMH200-04
Inverter I/F	Yeon-Ho	SMW200-06	2.0mm, 6P, S/T	CN10 / SMH200-06
OSD I/F	Yeon-Ho	12505WR-12	1.25mm, 12p SMD	CN9 / 12505HS-12
DC In (12V)	Yeon-Ho	DC-005(2.5PAI)		J12 / DC Adapter
SMPS In (12V)	Yeon-Ho	SMW250-12	2.5mm, 12P, S/T	CN6 / SMH250-12
Touch Power (5V)	Yeon-Ho	SMW200-04	2.0mm, 4P, S/T	CN7 / SMH200-04
Juke Box Switching	Yeon-Ho	SMW200-03	2.0mm, 3P, S/T	CN11 / SMH200-03
Audio Volume Control	Yeon-Ho	SMWA200-03	2.0mm, 3P, R/A	CN12 / SMH200-03

6.2 Pin Information Detail

6.2.1 LCD Interface : LVDS 30Pin (12507WR-30P) / CN2

Pin No.	Function	Pin No.	Function	Pin No.	Function	Pin No.	Function	Pin No.	Function
1	Vcc	7	GND	13	RXE2-	19	RXE0-	25	RXO2+
2	Vcc	8	RXE3+	14	GND	20	RXO3+	26	RXO2-
3	Vcc	9	RXE3-	15	RXE1+	21	RXO3-	27	RXO1+
4	NC	10	RXEC+	16	RXE1-	22	RXOC+	28	RXO1-
5	NC	11	RXEC-	17	GND	23	RXOC-	29	RXO0+
6	NC	12	RXE2+	18	RXE0+	24	GND	30	RXO0-

6.2.2 DVI Input (DVI D-Type) / JK3

Pin No.	Function	Pin No.	Function	Pin No.	Function	Pin No.	Function	Pin No.	Function
1	TX2-	6	DDC CLK	11	TX 1/3 Shield	16	H/P Detect	21	NC
2	TX2+	7	DDC data	12	NC	17	TX0 -	22	TXClk Shield
3	Data2/4 Shield	8	NC	13	NC	18	TX0 +	23	TXCLK+
4	NC	9	TX1-	14	DC +5V	19	TX0/5 Shield	24	TXCLK-
5	NC	10	TX1+	15	Ground	20	NC		



6.2.3 HDMI Input

Pin	Function	Pin	Function	Pin	Function	Pin	Function	Pin	Function
1	Data2 +	5	Data1 Shield	9	Data0 -	13	CEC	17	DDC/CEC GND
2	Data2 Shield	6	Data1 -	10	CLK +	14	NC	18	DC +5V
3	Data2 -	7	Data0 +	11	CLK Shield	15	DDC SCL	19	HP Detect
4	Data1 +	8	Data0 Shield	12	CLK -	16	DDC SDA		

6.2.4 VGA Input (D-SUB 15Pin) / J5

Pin No.	Function	Pin No.	Function	Pin No.	Function	Pin No.	Function
1	Red	5	Check Signal	9	NC	13	HSYNC
2	Green	6	GND	10	GND	14	VSYSNC
3	Blue	7	GND	11	NC	15	DDC_SCL
4	NC	8	GND	12	DDC_SDA		

6.2.5 RS232C Control : CN8 (SMW200-04)

Pin No.	Function	Pin No.	Function	Pin No.	Function	Pin No.	Function
1	RX	2	GND	3	TX	4	GND

6.2.6 C-VBS Input : J8 (RCA Jack)

Pin No.	Function	Pin No.	Function	Pin No.	Function
1	GND	2	CVBS	3	CVBS

6.2.7 Inverter Interface : CN10 (SMW200-06)

Pin No.	Function	Pin No.	Function	Pin No.	Function
1	+12V	3	GND	5	On/Off
2	+12V	4	GND	6	Dimmer

6.2.8 OSD Interface : CN9 (12505WR-12)

Pin No.	Function	Pin No.	Function	Pin No.	Function	Pin No.	Function
1	Menu	4	Power	7	NC	10	Ground
2	Select	5	Up	8	LED Green	11	5 V
3	Down	6	Function	9	LED Red	12	IR Data

6.2.9 12V DC In : J12 (DC-005)

Pin No.	Function	Pin No.	Function	Pin No.	Function
1	+12V	2	Detect	3	GND

6.2.10 SMPS Interface : CN6 (SMW250-12)

Pin No.	Function	Pin No.	Function	Pin No.	Function	Pin No.	Function
1	+5V	4	GND	7	SMPS +12V	10	GND
2	+5V	5	GND	8	On/Off	11	Inverter Dimmer
3	Standby +5V	6	SMPS +12V	9	GND	12	Inverter On/Off

6.2.11 Touch Controller Power : CN7 (SMW200-04)

Pin No.	Function	Pin No.	Function	Pin No.	Function	Pin No.	Function
1	+5V	2	+5V	3	GND	4	GND



6.2.12 Mode detection for Juke Box (switching cable connection) : CN11 (SMW200-03)

Pin No.	Function	Pin No.	Function	Pin No.	Function
1	Juke Box	2	NC	3	GND

6.2.13 Audio Volume Control : CN12

Pin No.	Function	Pin No.	Function	Pin No.	Function
1	Volume	2	Mute	3	STB

It allows to integrate the separate daughter board which has been made by Green C&C Tech additionally as an option. (part no : GH522A)

7. Setup for Operation

The OSD (On Screen Display) provides certain functions to have clear image and others. This board supports 5 buttons OSD Menu operation as a standard. The control functions defined on OSD operation are as below.

7.1 Functions on OSD Menu

OSD MENU	Description
Picture Mode	Picture preset mode. (Standard, Dynamic, Soft, Personal)
Contrast	Adjust the contrast of the screen.
Brightness	Adjust the brightness of the screen.
Backlight	Adjust the backlight of the screen.
Sharpness	Adjust the sharpness of the screen's image.
Tint	Adjust the tint of the screen's image.
Color	Adjust the color of the screen's image.
Color Mode	Adjust color temperature of the screen's image.
H-Pos	Adjust the horizontal position of the screen's image
V-Pos	Adjust the vertical position of the screen's image
Clock	Adjust the horizontal size of the screen's image
Phase	Adjust the focus of the screen's image
Auto	Automatically adjust the Horizontal position, Vertical position, Window's background or characters should be displayed on your full screen prior to precede this function.
3D NR	Select NR mode. (Standard, Strong, Auto, Off, Weak)
Menu Language	Select the OSD language. (English, Française, Deutsch, Italiano, Español, Nederlands)
Transparency	Adjust the OSD transparency level. (0 ~ 100%)
OSD Time Out	Define OSD time out. (5Sec ~ 60Sec)
Restore Default	Initializing that memory by factory presetting except OSD language.
Sleep Timer	Adjust the sleep timer. (0 ~ 240Min)
Zoom Mode	Select the zoom mode. (Normal, Wide, Zoom)
Image Flip	Image is reversed by vertical. (On, Off)
Image Mirror	Image is reversed by horizontal. (On, Off)
Auto Source	Detect the valid input source automatically. (On, Off)
XGA Mode	Select the resolution of RGB input. (1024x768, 1280x768, 1360x768, 1366x768)
HDMI Mode	Select the HDMI image setting. (PC, Video, No Overscan)
Source	Select video input source using OSD or direct key in Remocon.



7.2 Caution

Once having been fit up all the components or having been downloaded by a revised Hex file, all users are requested to the following procedures ;

- **Menu --> Option --> Restore Default --> Yes : press enter**
- **Menu --> Function --> Zoom Mode --> "Normal" for 4 : 3 format displays, "Wide" for 16 : 9 format displays and also all other wide format displays**
- **Menu --> Function --> HDMI --> PC for just RGB or DVI on the computer connection and Video No Over Scan for DVD Player or other Video setting case**

Having been executed the above procedure. Then all users don't need to do it again until any firmware update or change.

7.3 Menu Selection on the OSD Menu

There are 2 kinds of OSD Menu selections

7.3.1 by the Remote Controller (optional accessory)



When user uses the remote controller, press the "source" button, then the below "Input Source" windows comes up on the left top of screen. Then, whatever user need to settle the activation among the 4 kinds of input signal.

ex : see below picture

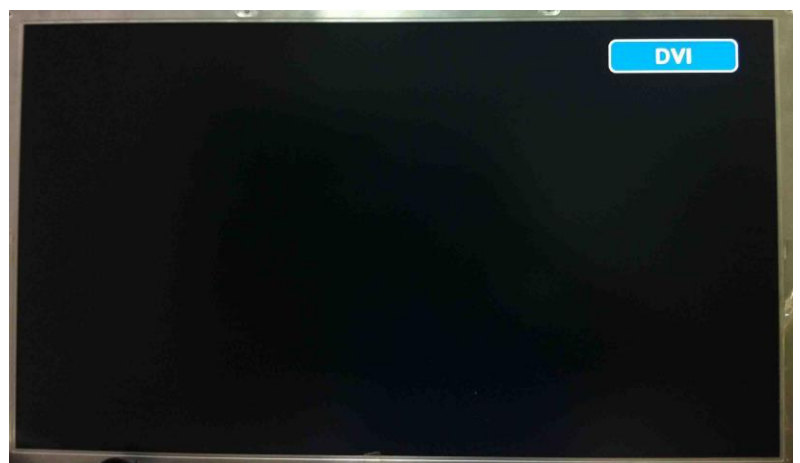

7.3.2 by the OSD board manually (standard accessory - 5 Button Key Pad type)

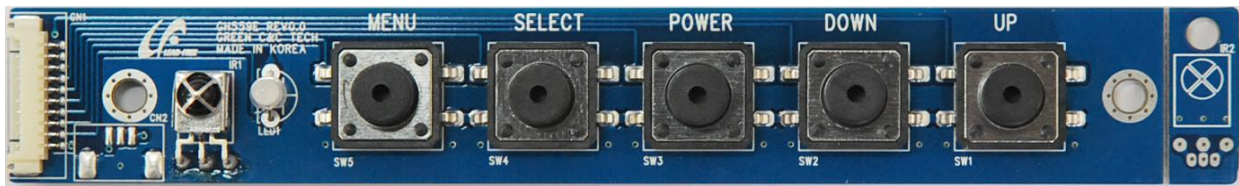

The manual setting can be done by the pressing the above buttons.
The setting algorithm is very the same as the logic of Key board of normal computer.

There are some hot keys are reserved for users' convenience as follows.

Pressing method the buttons	Function
double click the Down key	Auto Adjust
just pressing the Down key without leaving the finger	Dimming down (luminance getting decrease gradually)
just pressing the Up key without leaving the finger	Dimming up (luminance getting increase gradually)

7.4. OSD Menu Tree

The signal source selection:

- Press the "Set" button on the OSD Board & Press the Remote Controller (RGB, DVI, HDMI, CVBS)
- When user activates the "Auto Color" menu, there must be existed the black and white clearly as background image. (the most easiest condition : please use the Auto Color menu when the background image is opened the MS-Word or Excel file on the screen)

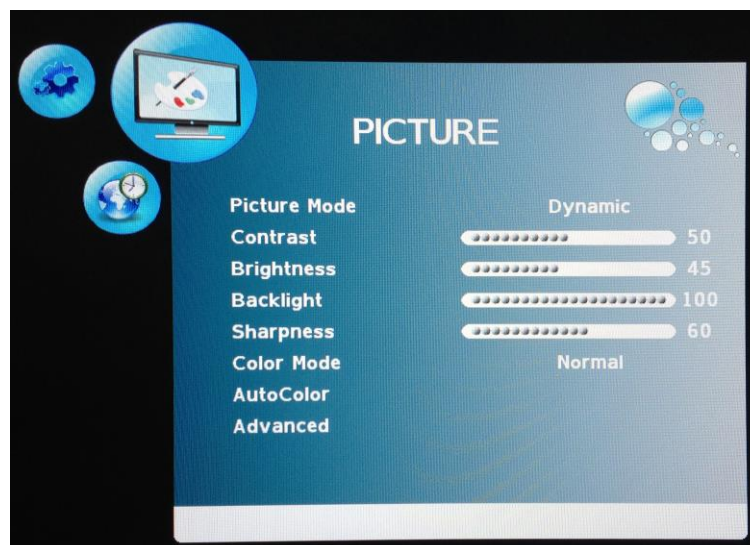

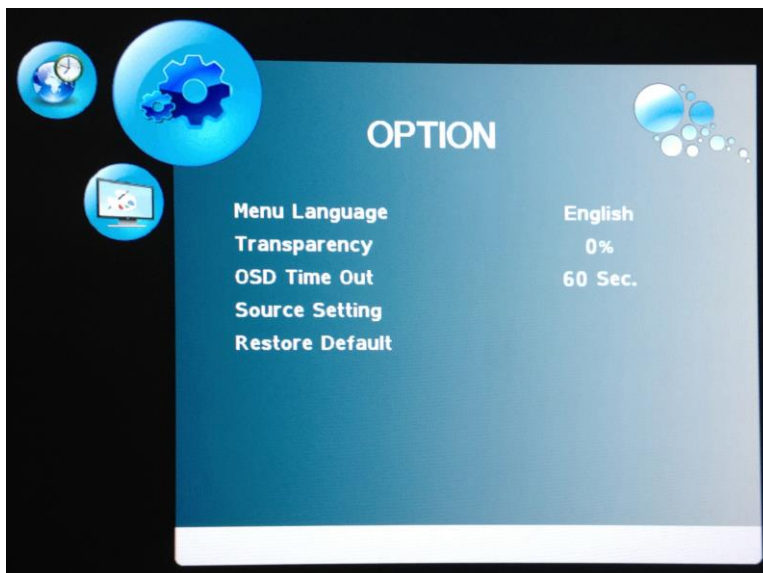

Icon	Main Menu	Sub menu
Option : Common Function		
	Menu Language	English / Française / Deutsch / Italiano / Español / Nederlands / 日本語
	Transparency	0 ~ 100 %
	OSD Time Out	5, 15, 30, 45, 60, OFF (Sec)
	Source Setting	CVBS / HDMI / DVI / RGB : " ON " or " OFF " respectively
	Restore Default	YES / NO

Icon	Main Menu	Sub menu	
Picture : Applied the signal source for RGB (VGA input) and/or DVI			
RGB: Picture Mode, Contrast, Brightness, Backlight, Sharpness, Color Mode, Auto Color, Advanced			
DVI : Picture Mode, Contrast, Brightness, Backlight, Sharpness, Color Mode			
	Picture Mode	Standard / Dynamic / Soft / Personal	
	Contrast	0 ~ 100	
	Brightness	0 ~ 100	
	Backlight	0 ~ 100	
	Sharpness	0 ~ 100	
	Color Mode	Normal / Warm / Cool / User (R/G/B)	
	Auto Color		
	Advanced	H-Pos	
		V-Pos	
		Clock	
Phase			
	Auto		

Icon	Main Menu	Sub menu
Picture : Applied the signal source for C-VBS and/or HDMI		
	Picture Mode	Standard / Dynamic / Soft / Personal
	Contrast	0 ~ 100
	Brightness	0 ~ 100
	Backlight	0 ~ 100
	Sharpness	0 ~ 100
	Tint	-50 ~ +50
	Color	0 ~ 100
	Color Mode	Normal / Warm / Cool / User (R/G/B)
	3D NR	Standard / Strong / Auto / Off / Weak

The sub menu screen of source setting ;

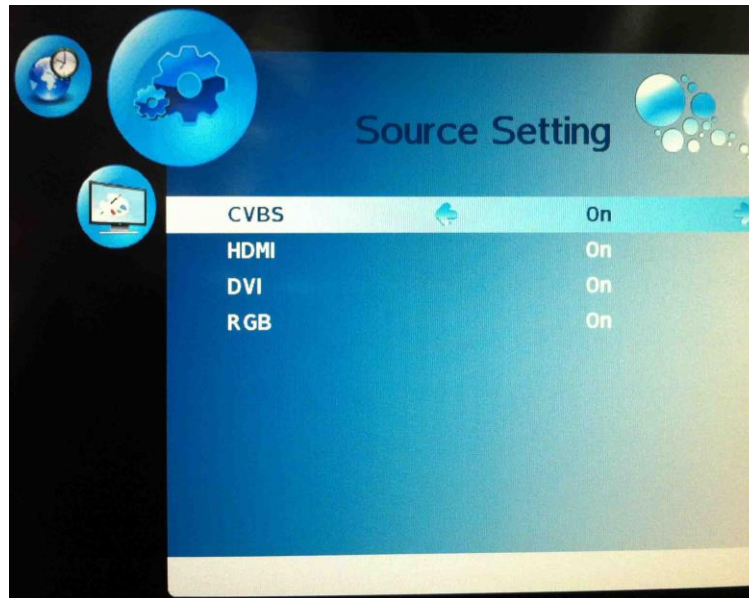



Icon	Main Menu	Sub menu
Function : Common Function RGB & CVBS : Sleep Timer, Zoom Mode, Image Flip, Image Mirror, Auto Source, XGA Mode DVI & HDMI : Sleep Timer, Zoom Mode, Image Flip, Image Mirror, Auto Source, XGA Mode, HDMI Mod		
	Sleep Timer	OFF ~ 240 MIN
	Zoom Mode	Normal / Wide / Zoom (for CVBS & HDMI)
		Normal / Wide (for RGB & DVI)
	Image Flip	ON / OFF
	Image Mirror	ON / OFF
	Auto Source	ON / OFF
	XGA Mode	1024x768 / 1280x768 / 1360x768 / 1366x768
HDMI Mode	PC / Video / No Overscan	

In case of resolution setting "XGA Mode" on the above, it has almost things to do with the TFT Displays which have only the following resolutions ;

- . **1024 x 768**
- . **1280 x 768**
- . **1366 x 768**
- . **1360 x 768**

Therefore, if the user need to apply the other wide XGA models such as the 1280 x 800 TFT display, the users don't need to select this "XGA Mode" setting but just skip this setting procedure.



8. Applicable Graphic Mode

The microprocessor measures the H-sync, V-sync and V-sync/H-sync polarity for RGB inputs, and uses this timing information to control all of the display operation to get the proper image on a screen.

This board can detect all VESA standard and MAC Graphic modes shown on the table below and provide more clear and stable image on a screen.

Table 8.1) RGB Input format

Mode \ Spec.	Pixel Freq.		Horizontal Timing				Vertical Timing			
			Sync Polar	Freq.	Total	Active	Sync Polar	Freq.	Total	Active
	MHz			KHz	Pixel	Pixel		Hz	Line	Line
640x350 @70Hz	25.144	VESA	P	31.430	800	640	N	70.000	449	350
720x400 @70Hz	28.287	VESA	N	31.430	900	720	P	70.000	449	400
640x480 @60Hz	25.175	MAC	N	31.469	800	640	N	59.940	525	480
640x480 @60Hz	25.175	VESA	N	31.469	800	640	N	59.940	525	480
640x480 @67Hz	30.240	MAC	N	35.000	864	640	N	66.667	525	480
640x480 @72Hz	31.500	VESA	N	37.861	832	640	N	72.809	520	480
640x480 @75Hz	31.500	VESA	N	37.500	840	640	N	75.000	500	480
832x624 @75Hz	57.284	MAC	N	49.726	1152	832	N	74.551	667	624
800x600 @56Hz	36.000	VESA	P	35.156	1024	800	P	56.250	625	600
800x600 @60Hz	40.000	VESA	P	37.879	1056	800	P	60.317	628	600
800x600 @72Hz	50.000	VESA	P	48.077	1040	800	P	72.188	666	600
800x600 @75Hz	49.500	VESA	P	46.875	1056	800	P	75.000	625	600
1024x768 @60Hz	65.000	VESA	N	48.363	1344	1024	N	60.005	806	768
1024x768 @60Hz	64.000	MAC	N	48.780	1312	1024	N	60.001	813	768
1024x768 @70Hz	75.000	VESA	N	56.476	1328	1024	N	70.070	806	768
1024x768 @75Hz	80.000	MAC	N	60.241	1328	1024	N	74.927	804	768
1024x768 @75Hz	78.750	VESA	P	60.023	1312	1024	P	75.030	800	768
1280x768 @60Hz	79.500	VESA	P	47.780	1664	1280	P	59.870	798	768
1280x1024 @60Hz	108.000	VESA	P	63.981	1688	1280	P	60.020	1066	1024
1280x1024 @75Hz	135.000	VESA	P	79.976	1688	1280	P	75.025	1066	1024
1360x768 @60Hz	85.000	VESA	P	47.712	1792	1360	P	60.015	795	768
1600x1200 @60Hz	160.875	VESA	N	74.479	2160	1600	P	59.967	1242	1200
1680x1050 @60Hz	147.000	VESA	N	65.160	2256	1680	P	59.944	1087	1050
1920x1080 @60Hz	172.750	VESA	N	67.061	2576	1920	P	59.983	1118	1080
1920x1200 @60Hz	193.125	VESA	N	74.508	1292	1920	P	59.990	1242	1200



9. Appendix - A (Option : 24V DC Power Board)

This is an optional daughter board which can support the direct power supply (24V DC) from a SMPS or System Power, then discharges the 12V DC to AD card or similar devices and the 24V DC by-pass to backlight of LCD display directly.

Output Characteristics

ITEM	SYMBOL	SPECIFICATION			UNIT
		MIN	TYP	MAX	
INPUT VOLTAGE	V_{in}	21.6	24	26.4	Vdc
INPUT CURRENT	I_{in}	-	-	2	Adc
OUTPUT VOLTAGE	V_o	10.8	12	13.2	Vdc
OUTPUT CURRENT	I_{o1}	-	-	3.0	Adc

9.1 Block Diagram

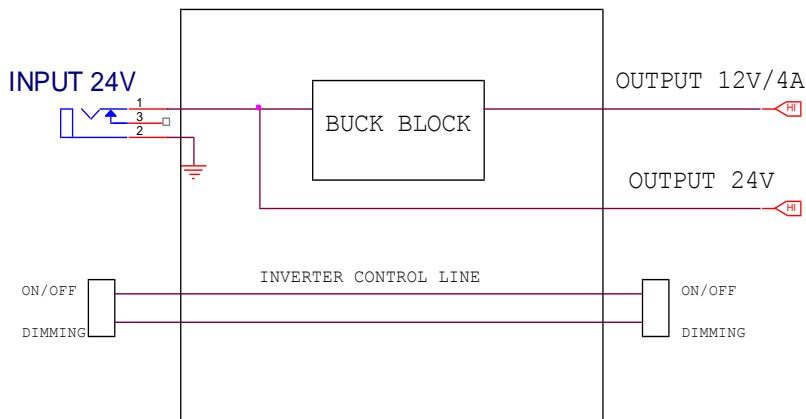

10.2 Dimension and Picture

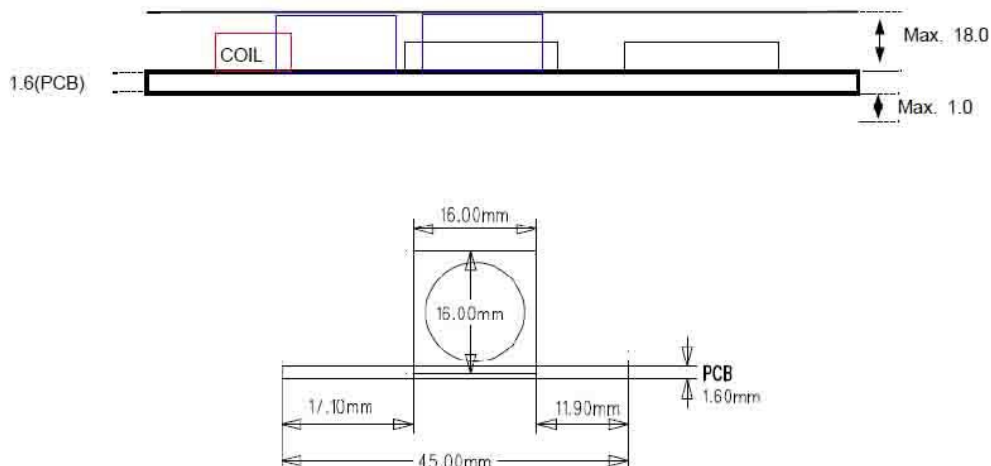

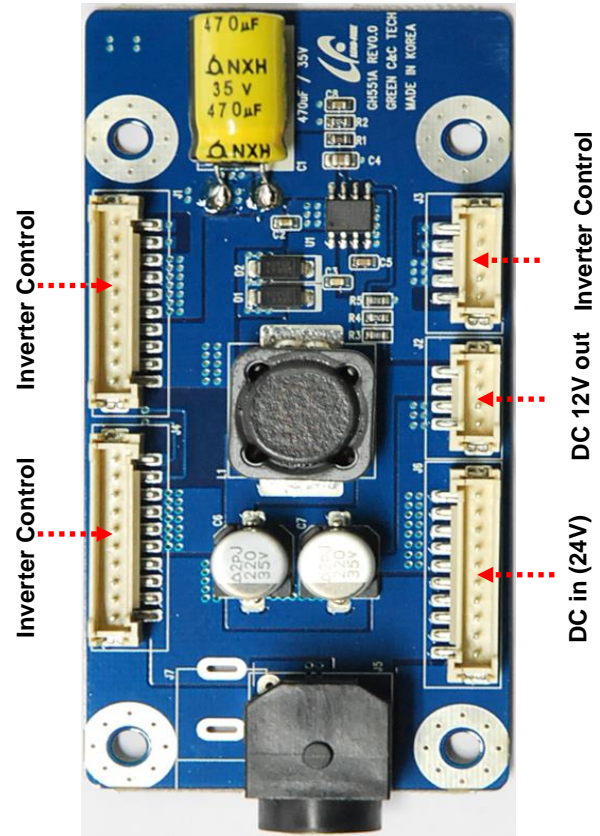
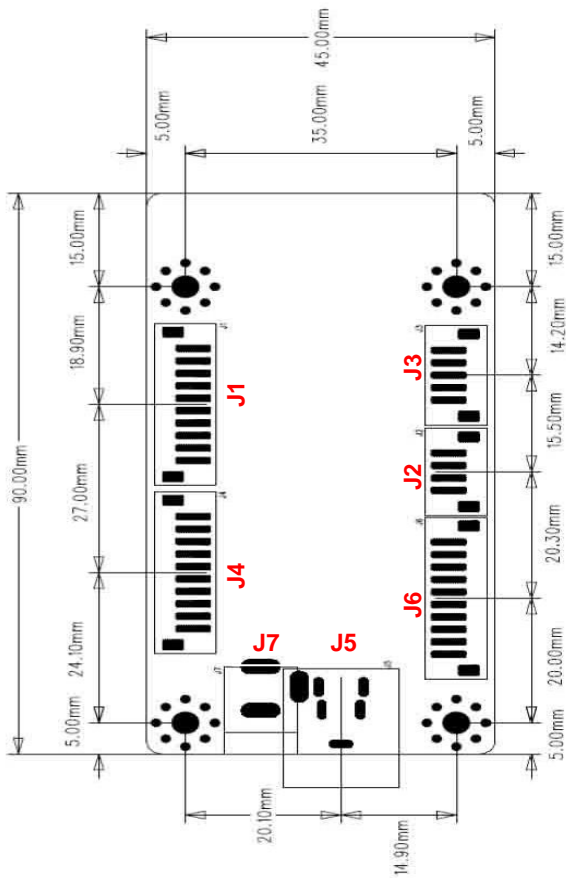

9.3.1 J1 & J4 / Inverter Control output Connector SMW200-H10G / Yeon-Ho

Pin No	Symbol	Pin No	Symbol	Pin No	Symbol	Pin No	Symbol
1	Inv. On / Off	2	Dimming	3 ~ 6	GND	7 ~ 10	24V

9.3.2 J2 / Inverter Control input Connector SMW200-H05G / Yeon-Ho

Pin No	Symbol	Pin No	Symbol	Pin No	Symbol	Pin No	Symbol
1	N.C.	2 ~ 3	GND	4	Dimming	5	Inv. On / Off

9.3.3 J3 / 12V DC Output Connector SMW200-H04G / Yeon-Ho

Pin No	Symbol	Pin No	Symbol	Pin No	Symbol	Pin No	Symbol
1	GND	2	GND	3	12V	4	12V

9.3.4 J5 / 24V DC Jack Connector DIN-422(BSUN) / Yeon-Ho

Pin No	Symbol	Pin No	Symbol	Pin No	Symbol	Pin No	Symbol
1	+24V	2	GND	3	+24V	4	GND

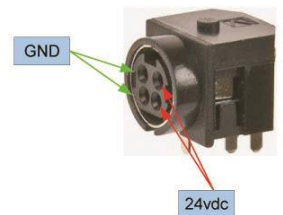

9.3.5 J6 / 24V DC Power Input Connector SMW200-H10G / Yeon-Ho

Pin No	Symbol	Pin No	Symbol
1 ~ 5	24V	6 ~ 10	GND

9.3.5 J7 / 24V DC Power Input Jack (round type) / Yeon-Ho



10. Appendix - B (Option : Audio + 24V DC Daughter board)

This is an optional daughter board which can support the direct power supply (24V DC) from a SMPS or System Power then discharges the 12V DC to AD card or similar devices and the 24V DC by-pass to backlight of LCD display directly. and also it serves the Audio system as well.

10.1 Electrical Characteristics

10.1.1 Audio Control Signal

Pin No.	Symbol	Status	Action	Remarks
CN2 #3	STB	HIGH	LAMP-ON	2.4~5.25V
		LOW	LAMP-OFF	0.8V MAX

10.1.2 Output Characteristics

Item	Symbol	Min	Typ	Mzx	Unit
Input Voltage	Vin	21.6	24	26.4	Vdc
Input Current	Iin	-	-	2	Adc
Output Voltage	Vo	10.8	12	13.2	Vdc
Output Current	Io1~2	-	-	1.5	Adc

10.1.3 Block Diagram

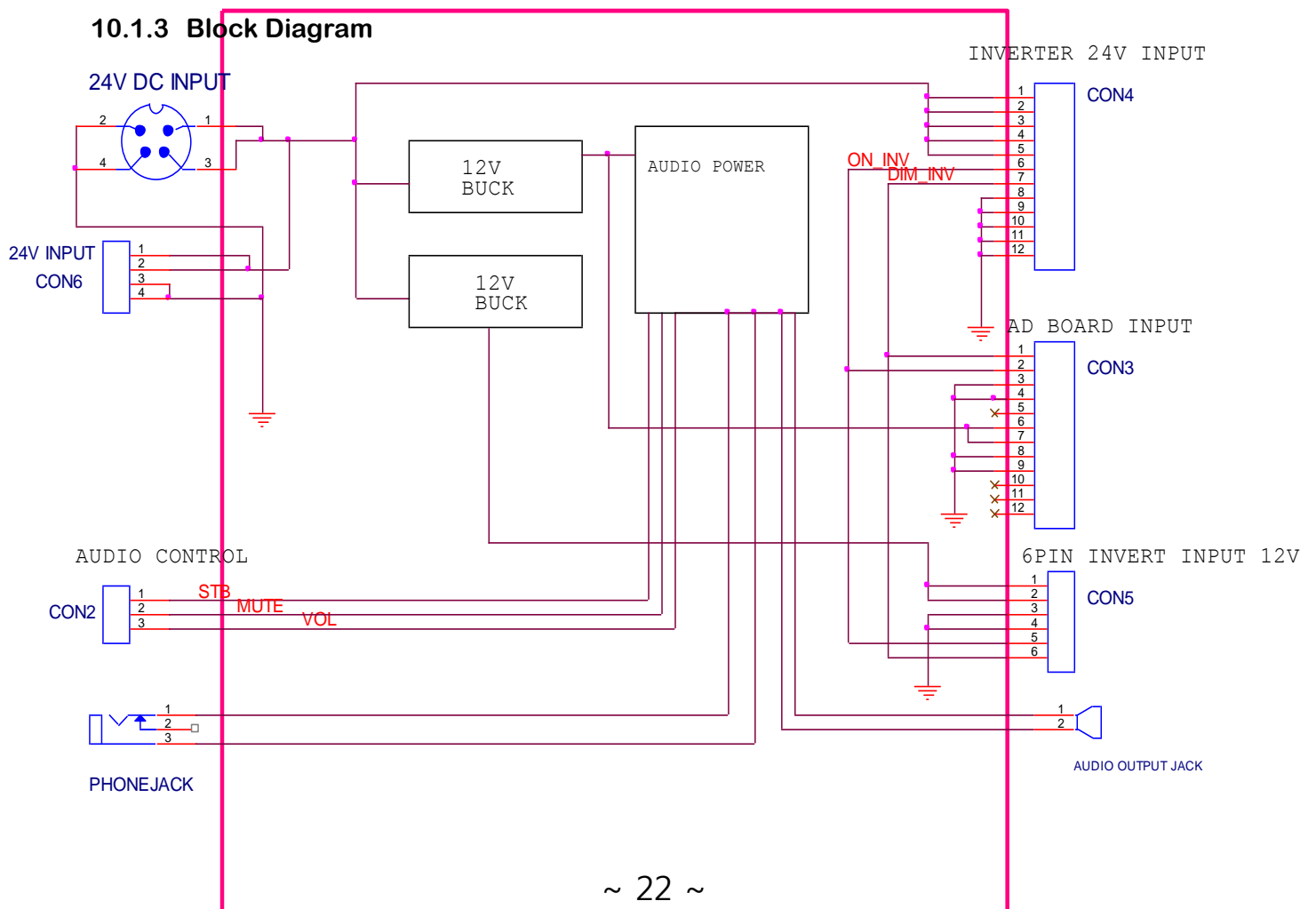



10.2 Dimension and Picture (100 X 60 mm)

10.2.1 Top View

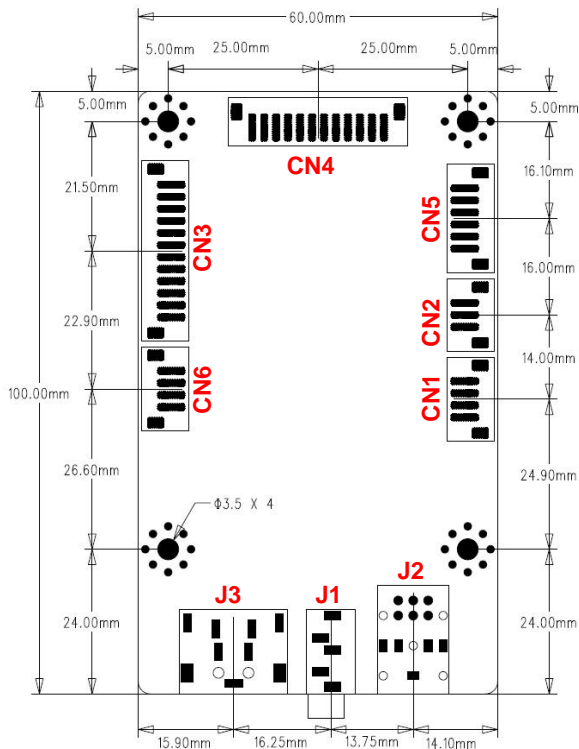

10.2.2 Side View

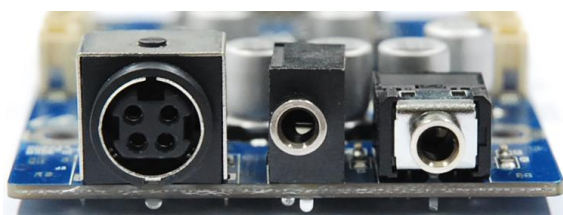
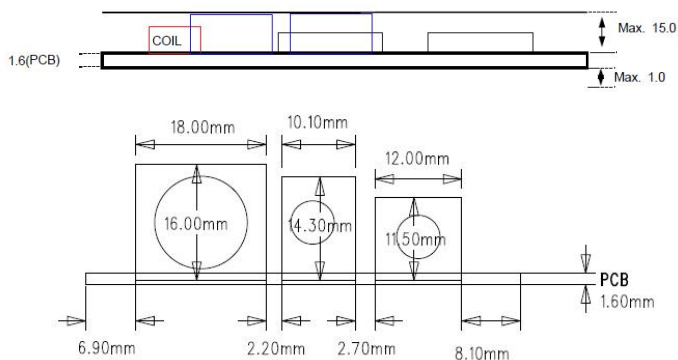

24V Ac/DC adaptor Type
(connect with J3 barrel jack)

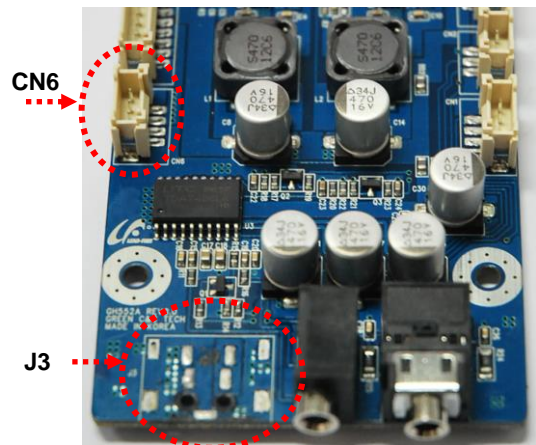
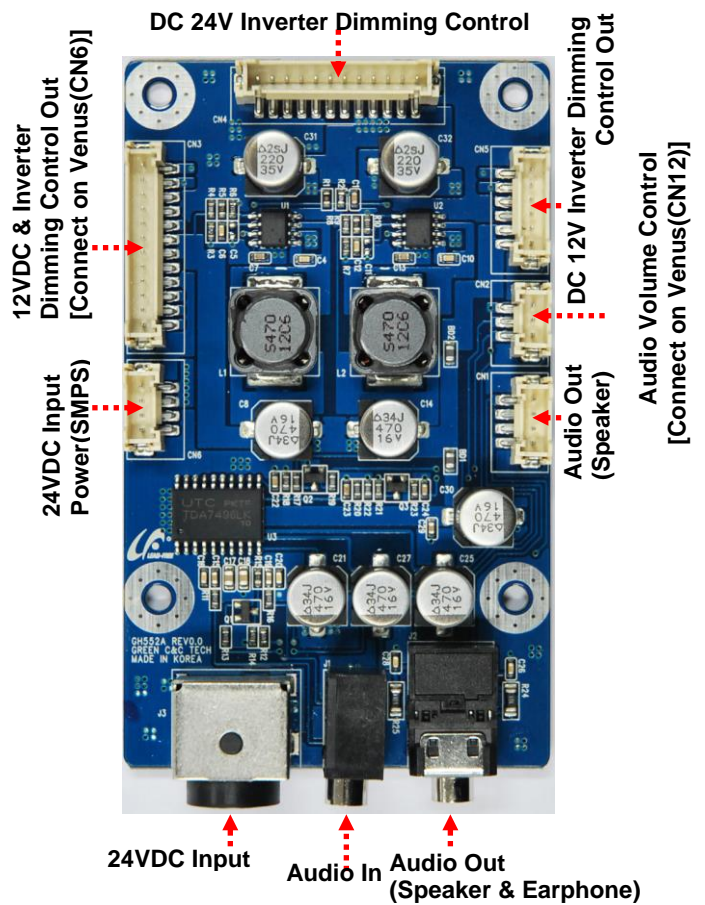

User's System Power or SMPS type
(connect with CN6 SIL connector)

10.3 Pin Information

10.3.1 CN1 / Audio Out SMW200-H04G(YEON-HO)

Pin No	Symbol	Pin No	Symbol	Pin No	Symbol	Pin No	Symbol
1	Out_R	2	GND	3	GND	4	Out_L

10.3.2 CN2 / Audio Volume Control SMW200-H03G(YEON-HO)

Pin No	Symbol	Pin No	Symbol	Pin No	Symbol
1	STB	2	MUTE	3	VOL

10.3.3 CN3 / 12VDC & Inverter Dimming Control Out SMW200-H12G(YEON-HO)

Pin No	Symbol	Pin No	Symbol	Pin No	Symbol
1	N/C	5	GND	9	GND
2	N/C	6	+12V	10	GND
3	N/C	7	+12V	11	ON_INV
4	GND	8	N/C	12	DIM_INV

10.3.4 CN4 / DC 24V Inverter Dimming Control SMW200-H12G(YEON-HO)

Pin No	Symbol	Pin No	Symbol	Pin No	Symbol
1	+24V	5	+24V	9	GND
2	+24V	6	ON_INV	10	GND
3	+24V	7	DIM_INV	11	GND
4	+24V	8	GND	12	GND

10.3.5 CN5 / DC 12V Inverter Dimming Control Out SMW-200H06G(YEON-HO)

Pin No	Symbol	Pin No	Symbol	Pin No	Symbol
1	+12V INV	3	GND	5	ON_INV
2	+12V INV	4	GND	6	DIM_INV

10.3.6 CN6 / 24VDC Input Power(SMPS) SMW-H04G(YEON-HO)

Pin No	Symbol	Pin No	Symbol	Pin No	Symbol	Pin No	Symbol
1	+24V	2	+24V	3	GND	4	GND

10.3.7 J1 / Audio In PJ-325(BSUN)

Pin No	Symbol	Pin No	Symbol	Pin No	Symbol
1	GND	3	PC_R	5	PC_L
2	GND	4	GND		

10.3.8 J2 / Audio Out PJ-306B(BSUN)

Pin No	Symbol	Pin No	Symbol	Pin No	Symbol
1	GND	3	N.C.	5	OUT_L
2	OUT_R	4	N.C.		

10.3.9 J3 / 24VDC Input Jack DIN-422(BSUN)

Pin No	Symbol	Pin No	Symbol	Pin No	Symbol	Pin No	Symbol
1	+24V	2	GND	3	+24V	4	GND

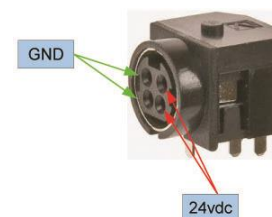



11. Appendix - C (Option : RS232C Protocols)

11.1 RS-232 Serial control

- Baud rate : 38400
- Data bit : 8 bits
- Stop bit : 1
- Parity bit : No

11.2 Physical connection :

Controller side:
 Connector interface: CN8
 Mating connector: DB9 Female or
 20010HS-04, Yeon-Ho

Computer side:
 Connector interface: Serial port
 Mating connector: DB9 Male

PIN#	Description
1	RS-232 Rx Data
2	Ground
3	RS-232 Tx Data
4	Ground

PIN#	Description
2	RS-232 Rx Data
3	RS-232 Tx Data
5	Ground

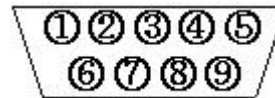
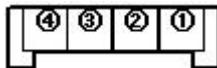

11.3 RS-232 Serial Protocols

Command	Header (1)	Command (1)	*Data Type (1)	*Data (1)	*Check (1)	
Remocon Function	Request 0xAA	0x01	0x00	*Key Code	-	
Power		Response 0x55	0x03	0x00: Value 0xFF: Status Read	0x00 Power On	-
					0x0A Power Off	-
					0xFF Status Read	-
Picture Mode		0x10	0x00: Value 0x80: Decrease by 1 0x81: Increase by 1 0xFF: Data Read	0x00 Standard	-	
Contrast		0x11		0x01 Dynamic		
				0x02 Soft		
Brightness	0x12	0x03 Personal				
Sharpness	0x13	0x00	0	-		
			~	~	-	



			0x64	100	
Tint		0x14	0x00	0	-
			~	~	
			0x64	100	
Color		0x15	0x00	0	-
			~	~	
			0x64	100	

Command	Header (1)	Command (1)	*Data Type (1)	*Data (1)	*Check (1)
Color Mode		0x16		0x00 Normal 0x01 Warm 0x02 Cool 0x03 User	-
Color Red		0x17		0x00 0 ~ ~ 0xFF 255	
Color Green		0x18		0x00 0 ~ ~ 0xFF 255	
Color Blue		0x19		0x00 0 ~ ~ 0xFF 255	
3DNR		0x1A		0x00 Off 0x01 Weak 0x02 Standard 0x03 Strong 0x04 Auto	-
Backlight		0x1B		0x00 0 ~ ~ 0x64 100	
Auto Color		0x1C	0x00	0x00 Execution	
Adv. H-Position	Request 0xAA Response 0x55	0x20	0x80: Decrease by 1 0x81: Increase by 1 0xFF: Data Read	0x00 0 ~ ~ 0x64 100	-
Adv. V-Position		0x21		0x00 0 ~ ~ 0x64 100	-
Adv. Clock		0x22		0x00 0 ~ ~ 0x64 100	-
Adv. Phase		0x23		0x00 0 ~ ~ 0x64 100	-
Adv.Auto		0x24	0x00	0x00 Execution	
Adv. H-Position	Request	0x20	0x80: Decrease by 1	0x00 0	-



	0xAA		0x81: Increase by 1 0xFF: Data Read	~ 0x64	~ 100	
Adv. V-Position	Response 0x55	0x21		0x00 ~ 0x64	0 ~ 100	-
Adv. Clock		0x22		0x00 ~ 0x64	0 ~ 100	-

Command	Header (1)	Command (1)	*Data Type (1)	*Data (1)		*Check (1)		
Adv. Phase		0x23		0x00 ~ 0x64	0 ~ 100	-		
Adv.Auto		0x24	0x00	0x00	Execution			
Menu Language	Request 0xAA	0x40	0x00: Value 0x80: Decrease by 1 0x81: Increase by 1 0xFF: Data Read	0x00 0x01 0x02 0x03 0x04 0x05 0x06	English French Spanish Deutsch Nederland Italiano Japanese			
Transparency		0x41		0x00 0x01 0x02 0x03 0x04	100% 75% 50% 25% 0%			
OSD Time Out		0x42		0x00 0x01 0x02 0x03 0x04 0x05	Off 5 Sec. 15 Sec. 30 Sec. 45 Sec. 60 Sec.			
Restore Default		0x43		0x00	0x00	Execution		
CVBS Source Setting		0x44						
HDMI Source Setting		0x45			0x00: Value 0x80: Decrease by 1 0x81: Increase by 1 0xFF: Data Read	0x00 0x01	Off On	
DVI Source Setting		0x46						
RGB Source Setting		0x47						
Sleep Timer		Request 0xAA		0x50	0x00: Value 0x80: Decrease by 1 0x81: Increase by 1 0xFF: Data Read	0x00 0x01 0x02 0x03 0x04	Off 1 Min. 5 Min. 10 Min. 15 Min.	
		Response						



12. Appendix – D (Dip Switches' Setting and supportable LCD Panel List)

12.1 Reference Data

12.1.1 Limiting Value

Symbol	Description	Min	Max	Unit
DC In	Voltage Input	-	+12V	V(DC)
DC Out (LVDS VCC)	Voltage Output	-	+12V	V(DC)
Current Output (LVDS VCC)	Current Output			A(DC)
DC Out (Touch Power)	Voltage Output		+5V	V(DC)
Current Output(Touch Power)	Current Output			A(DC)

12.1.2 Etc. Data

Parameter	Value	Unit
Dimensions:		
Depth	100	mm
Width	140	mm
Height	20	mm
Operating Temperature	0 ~ 45	°C
Storage Temperature	-20 ~ 80	°C

12.2 Option Jumper Setting

12.2.1 LCD Vcc Selection Jumper (CN15)

Panel Vcc	Jumper Setting
+12V	
+5V	
+3.3V	

12.2.2 Inverter Control type Selection Jumper (CN18)

Panel Vcc	Jumper Setting
DC Level	
PWM	



12.2.3 Luminance Option for AUO15”(G150XG01-V3) & LG10.1”(LD101WX1-SL01), CN1

Panel Vcc	Jumper Setting
Disable	
	Normal



Enable	 USE 1 : G150XG01-V3 USE 2 : LD101WX1-SL01
---------------	---

12.2.4 LVDS Type selection; SW1

LVDS Type	Setting of the 8th switch
VESA (normal) format	
JEIDA format	

12.2.5 LCD Model Selection

(It will be updated continuously depending on firmware setting records)

Part Number & Resolution (1920 x 1200)		Part Number & Resolution (1600 x 1200)	
Part Number	Maker	Part Number	Maker
LM240WU8-SLA2	LG 24"	LTM213U6-L01	SAMSUNG 21.3"
LM240WU8-SLD1	LG 24"		
LTM240CT04	SAMSUNG 24"		

Part Number & Resolution (1920 x 1080)			
Part Number	Maker	Part Number	Maker
LTM230HP01	SAMSUNG 23"	G173HW01-V0	AUO 17.3"
LTM230HT10	SAMSUNG 23"	M215HW02-V0	AUO 21.5"
LTI400HA08	SAMSUNG 40"	M215HW03-V1	AUO 21.5"
LTI400HA10	SAMSUNG 40"	M215HTN01.1	AUO 21.5"
LTI460HM03	SAMSUNG 46"	G215HVN01-V0	AUO 21.5"
LTI460HA03	SAMSUNG 46"	G240HW01-V0	AUO 24"
LTI460HN03	SAMSUNG 46"	M240HVN02.1	AUO 24"
LTI460HN04	SAMSUNG 46"	T260HW02-V1	AUO 26"
LTI550HN03	SAMSUNG 55"	M270HVN02.1	AUO 27"
LTI550HF03	SAMSUNG 55"(120Hz)	M270HW02-V1	AUO 27"
LM215WF3-SLC1	LG 21.5"	P270HVN01.0	AUO 27"
LM215WF3-SLE1	LG 21.5"	T315HW07-VE	AUO 31.5"
LM215WF3-SLK1	LG 21.5"	P320HVN01.0	AUO 32"
LM230WF3-SLB1	LG 23"	P420HVN01.0	AUO 42"
LM230WF3-SLC1	LG 23"	P420HVN02.0	AUO 42"
LM230WF3-SLD1	LG 23"	P420HVN03.0	AUO 42"
LM230WF3-SLE1	LG 23"	P420HW03-V0	AUO 42"(120Hz)
LM230WF3-SLK1	LG 23"	T420HW08-V5	AUO 42"
LM238WF1-SLA1	LG 23.8"	P460HVN02.0	AUO 46"
LM238WF3-SLD1	LG 23.8"	P460HVN03.0	AUO 46"
LM270WF5-SLM1	LG 27"	P550HVN01.0	AUO 55"
LC320EUD-SEF1	LG 32"(120Hz)	P550HVN02.0	AUO 55"
LC420EUN-SDV3	LG 42"	P550HVN03.0	AUO 55"
LC420WUN-SBA1	LG 42"	P650HVN02.3	AUO 65"
LD420WUN-SCA1	LG 42"	LK695D3LA48	SHARP 69.5"
LD420WUB-SCA1 (Enhancement Version)	LG 42" (2000cd/m2)	LK695D3LA58	SHARP 69.5"
		LITEMAX AU2125	LITEMAX 21.5"



LD420WUB-SCA1 (Normal Version)	LG 42" (700cd/m2)	LD470EUD-SDA1	LG 47"(120Hz)
-----------------------------------	----------------------	---------------	---------------

Part Number & Resolution (1366 x 768)			
Part Number	Maker	Part Number	Maker
LTA320WT-L05	SAMSUNG 32"	LC185EXN-SCA1	LG 18.5"
LTA320W2-L01	SAMSUNG 32"	LC185EXN-SDA1	LG 18.5"
LTI320AP01	SAMSUNG 32"	G156XW01-V1	AUO 15.6"
LTI320AP02	SAMSUNG 32"	G185XW01-V1	AUO 18.5"
NL1366AC25-01D	NEC 15.6"		

Part Number & Resolution (1280 x 1024)			
Part Number	Maker	Part Number	Maker
LM170E03-TLHB	LG 17"	G170EG01-V0	AUO 17"
LM190E08-TLL3	LG 19"	G170EG01-V1	AUO 17"
LB190E02-SL01	LG 19"	M170ETN01.0	AUO 17"
LTM170E8-L01	SAMSUNG 17"	G190EAN01.0	AUO 19"
LTM170E8-L03	SAMSUNG 17"	G190EG02-V1	AUO 19"
LTM190E4-L02	SAMSUNG 19"	NL128102BC29-10	NEC 19"
LTM190ET01	SAMSUNG 19"	IDK-170N-K2SXA1	LITEMAX 17"

Part Number & Resolution (1024 x 768)			
Part Number	Maker	Part Number	Maker
NL10276BC24-13C	NEC 12.1"	G104X1-L01	CMI 10.4"
NL10276BC30-18C	NEC 15"	G104X1-L03	CMI 10.4"
NL10276BC30-34D	NEC 15"	G104X1-L04	CMI 10.4"
NL10276AC30-42C	NLT 15"	G121X1-L03	CMI 12.1"
NLB150XG01L-01	NLB 15"	G150X1-L01	CMI 15"
AA084XB01	MISTUBISHI 8.4"	G150X1-L02	CMI 15"
AA104XD02	MISTUBISHI 10.4"	G150X1-L03	CMI 15"
AA104XD12	MISTUBISHI 10.4"	G150XGE-L04	CMI 15"
AA121XL01	MISTUBISHI 12.1"	G150XG01-V3	AUO 15"
AA121XN11	MISTUBISHI 12.1"	G150XG01-V4	AUO 15"
AA150XS02	MISTUBISHI 15"	G150XG02-V1	AUO 15"
AA150XT11	MISTUBISHI 15"	G150XG03-V4	AUO 15"
AC150XA01	MISTUBISHI 15"	G150XG03-V2	AUO 15"
AA150XS11	MISTUBISHI 15"	(Enhancement Version)	(1500cd/m2)
TMS150XG1-10TB	TIANMA 15"	G150XG03-V2	AUO 15"
LB150X02-TL01	LG 15"	(Normal Version)	(250cd/m2)
LB150X02-TL02	LG 15"		

Part Number & Resolution (800 x 600)			
Part Number	Maker	Part Number	Maker
G121S1-L02	CMI 12.1"	NL8060BC21-11	NEC 8.4"
LB121S03-TL01	LG 12.1"	NL8060BC26-35D	NEC 10.4"
AA084SB01	MITSUBISHI 8.4"	NL8060BC26-35F	NEC 10.4"
AA084SB11	MITSUBISHI 8.4"	NL8060BC31-47D	NEC 12.1"
AA104SH12	MITSUBISHI 10.4"	G084SN05-V8	AUO 8.4"
AA104SG01	MITSUBISHI 10.4"	G084SN05-V9	AUO 8.4"
AC121SA01	MITSUBISHI 12.1"	G104SN02-V2	AUO 10.4"
		G121SN01-V4	AUO 12.1"

Part Number & Resolution (640 x 480)		Part Number & Resolution (1680 x 1050)	
Part Number	Maker	Part Number	Maker



NL6448BC20-21C	NEC 6.5"	LTM220MT09	SAMSUNG 22"
NL6448BC20-21D	NEC 6.5"	LTM220M1-L01	SAMSUNG 22"
NL6448BC20-30C	NEC 6.5"	G220SW01-V0	AUO 22"
NL6448BC20-30D	NEC 6.5"	G220SVN01.0	AUO 22"
G065VN01-V2	AUO 6.5"	M220ZGE-L20	CMI 22"

Part Number & Resolution (1280 x 800)			
Part Number	Part Number	Part Number	Maker
NL12880BC20-05	NEC 12.1"	LD101WX1-SL01	LG 10.1"
NL12880BC20-05D	NEC 12.1"	G154I1-LE1	CMI 15.4"
LTN101AL03	SAMSUNG 10.1"	AA121TD01	mitsubishi 12.1"
LTL101AL06	SAMSUNG 10.1"	AA141TC01	mitsubishi 14.1"

Part Number & Resolution (800 x 480)		Part Number & Resolution (1280 x 768)	
Part Number	Maker	Part Number	Maker
NL8048BC19-02	NEC 7"	AA106TA01	mitsubishi 10.6"
NL8048BC19-02C	NEC 7"	AA175TD01	mitsubishi 17.5"
NL8048BC24-09D	NEC 9"	NL12876AC18-03D	NEC 10.6"
NL8048AC19-14F	NLT 7"	NL12876BC26-28	NEC 15.3"
NL8048AC21-01F	NLT 8"	NL12876BC26-25	NEC 15.3"
AA080MB01	mitsubishi 8"	M170XW01-V2	AUO 17"
AA090MF01	mitsubishi 9"		
LB070WV8-SL01	LG 7"		

Part Number & Resolution (1440 x 900)		Part Number & Resolution (1920 x 540)	
Part Number	Maker	Part Number	Maker
M190PTN01.0	AUO 19"	JL270AT540A-V0	JUNGLIM 27" HALF
M190PW01-V8	AUO 19"		

Part Number & Resolution (1024 x 600)	
Part Number	Maker
NL10260BC19-01D	NEC 8.9"

" Please see the actual dip switch position for LCD panel selection and all the setting positions of jumper switches from the following pages. "